

# Surgical Instruments Catalogue

•Surgery •Chirurgie •Cirugía •Chirurgie

•Chirurgia



**fairmount**  
INDUSTRIES (PVT) LTD.

*"fairmount" Stand for Customers Total Satisfaction.  
Manufacturers & Exporters of Surgical, Dental  
Instruments & Scissors all Sorts.*



Sr. #

Page #

10

**ENT Surgery**

290 to 323



11

**Neurosurgery**

324 to 339



12

**Intestinal & Rectal Instruments**

340 to 351



13

**Gynecology / Obsterics**

352 to 380



14

**Urology Instruments**

381 to 390



15

**Hollow Wares**

391 to 399



16

**Index**

400 to 408



17

**Dental Catalogue**

409 to 456





Sr. # Page #

01

**Diagnostic Instruments**

01 to 14



02

**Trocars, Suction Tubes & Cannulas**

15 to 21



03

**Scalpel Handle, Scalpel Blades, Dissecting Knives & Saws**

22 to 29



04

**General Operating Scissors**

30 to 66



05

**Dressing & Tissue Forceps**

67 to 88



06

**Haemostatic Forceps**

89 to 123



07

**Needle Holders**

124 to 158



07

**Retractors**

159 to 210



08

**Bone Surgery Instruments**

211 to 289



09



Process Model

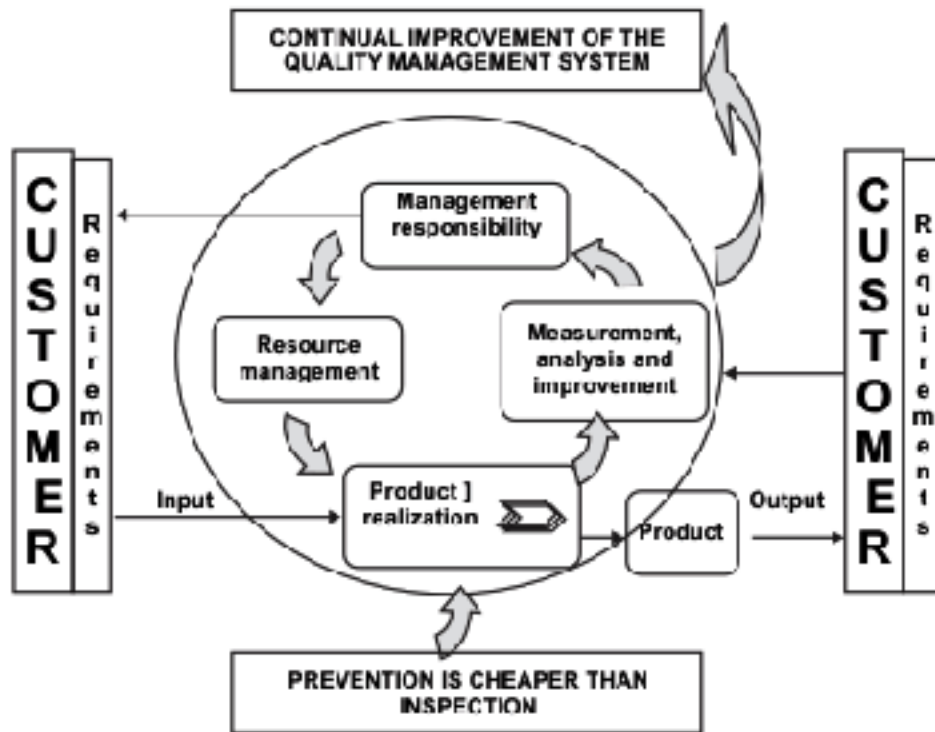

PROCESS FLOW CHART

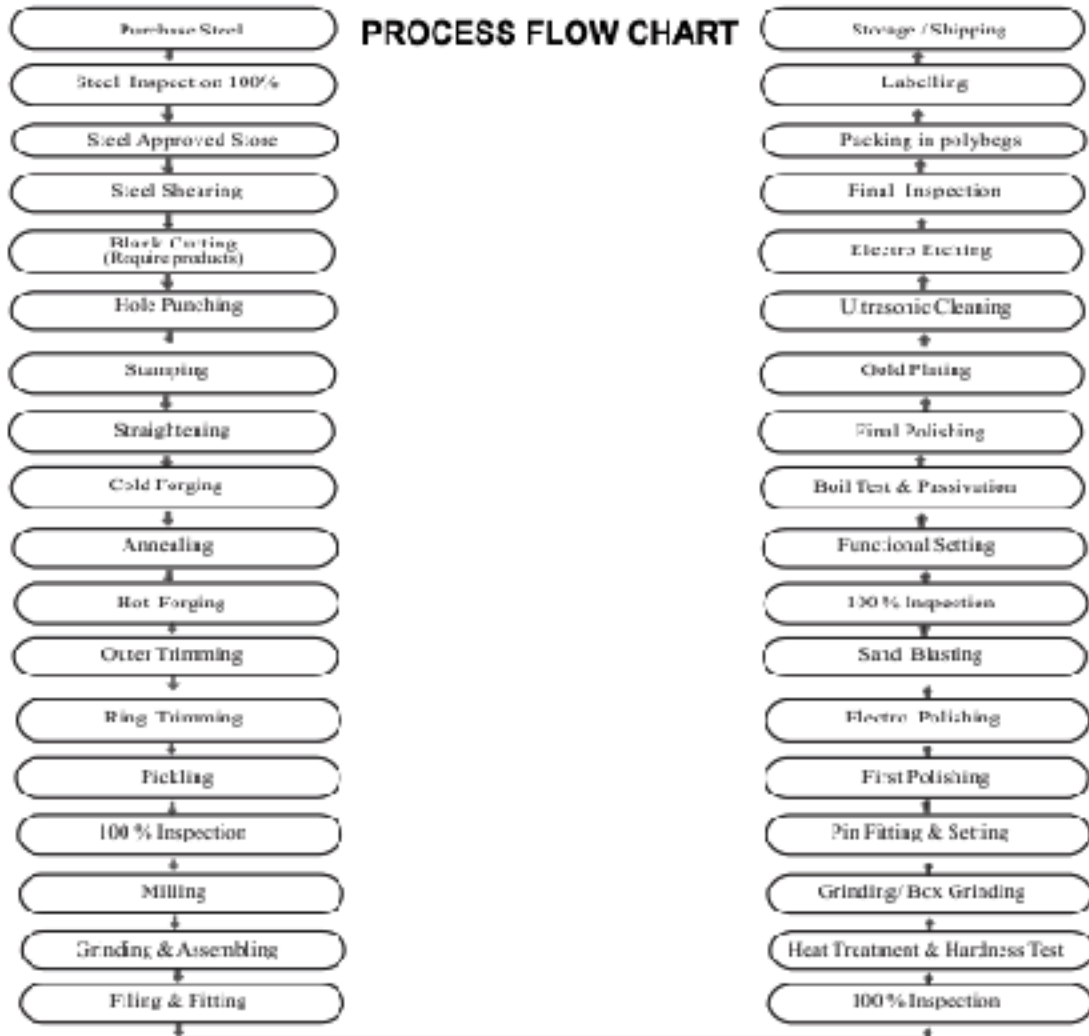



Fairmont Industries (Pvt.) Ltd. is an employee owned company of Craftsmen and has got a good reputation for quality and reliability. Our significant manufacturing steps are being described here-under briefly:

- 1. MATERIAL TESTING:** The purchased raw material is thoroughly tested under PCA. authority. A rigid quality control policy is being adopted before releasing to production. This test is taken to check the standard of steel as per desired specifications and is considered the most important factor of our business.
- 2. FORGING & HAMMERING:** After testing, the stainless steel strips/bars are divided into different sizes as per our requirements and our highly experienced craftsmen are specialized in forging (Hot/Cold Drop) to perform all standard press operations in forming and deep drawing of all type of instruments. We anneal the forging and prepare for the milling process.
- 3. MACHINE & TOOL WORK:** Our highly skilled technicians have a great knowledge about machine milling process. We form accurately male/female portion of box-joint forceps, as well as, serrations/ratches in uniformity. We are equipped to mill, drill, bore turn and grind all type of metals. We have in house facility of custom tool and die production, maintenance and repair.
- 4. FILING:** We are specialized in handmade fabrication. First, we assemble male/female portion after setting/adjusting of Extracting Forceps and Scissors, tips, serrations, ratches in uniformity and file precisely to make it semi-finish under strictly quality control specifications.  
We are now moving from basic hand manufacturing techniques to mechanization to production run.
- 5. HEAT TREATMENT:** All instruments are being tempered maintaining "Rock-Well Hardness" for Extracting Forceps & Retractor 45° to 50° degree and Scalp, Gauges and Scalpel 50° to 55° degree. A test is taken to check the hardness after tempering of each lot to maintain the uniformity and, before proceeding further, we clean all instruments by various chemicals. In addition, we will buy specialized Q/C equipment in near future to meet special customer Q/C. Specifications.
- 6. RIVETING & WELDING:** We perform a wide variety of assembly operations from prototype quantities to production run. We rivet precisely each instrument such as, Extracting Forceps & Retractor, etc. But, for some kind of instruments, we use spot welding.
- 7. GRINDING & POLISHING:** For precise grinding and excellent finish, we specialize in applying polishing wheels to belts to improve the overall finish in high uniformity utilizing best of polishing luster. We use electro-plating plants to polish serrations/ratches and joints of stainless steel instruments. For satin/matt finish instruments, we use glass heads to achieve uniformity. All instruments are being polished under rigid quality control specifications.
- 8. PASSIVATION:** This method actually provides the instruments with its corrosion resistance properties. Passivation, which follows the final polishing step, is a chemical bath, which creates an oxidized layer on the surface of instruments. We are now equipped with most modern process.
- 9. ULTRASONIC CLEANING:** We are full equipped with most modern ultrasonic cleaning plants imported from "Branson Cleaning Equipment Co. USA", and all instruments are being cleaned properly utilizing various chemicals such as, Tri-Chloroethylene etc.
- 10. INSPECTION & STAMPING:** We inspect all instruments under rigid Q/C. specifications and give the assurance to our relative clients that all instruments shall be free from all defects such as, burrs, sharp edges, cracks, pitting, scratches, grease / excessive oil and foreign matters etc. We also guarantee for its workmanship. For stamping, we use both process i.e. die cunk and electrolytic marking and are being marked under customer's specifications.
- 11. PACKING, LABELING AND BAR CODING:** We pack all instruments under strictly Q/C. specifications as per customer's demand. Normally, we pack individually in poly bag and further 12 pieces in one box mentioning outside with Part Number, Descriptor and Lot Number. All instruments are packed in poly bags/plastic/colour bags, Blister Packing with adequate desiccant in each poly bag to absorb moisture. We are specialized in packaging, labeling and bar coding as per customer demand.



## ***QUALITY SERVICES & CUSTOMER SATISFACTION***

*To provide "Excellent services and economically prices" is the motto of our business. All instruments are made of stainless steel other wise specified.*

*All instrument are stamped with words "stainless Pakistan or any other country to whom manufactured buyers own brand may also be engraved on demand, "Die-Sunk" procedure is generally used.*

*Special items can also be supplied if sketch, drawing or samples are provided to us or refer any reference from reputed catalogue for our guidance.*

*All kind of Surgical instruments of stainless steel made the specific material according to its use.*

### ***Specification of material used in production.***

	<b>Cutting Instruments</b>
For (scissors, Cutter)	Stainless steel AISI-410/420 (Rock-well hardness-48 to 58) Hot drop forged
For (Forceps, Holding Clamp)	Stainless steel AISI-410/420 (Rock-well hardness-42 to 48) Hot drop forged
For (Scalpel, Handles)	Stainless steel AISI-420 (Rock-well hardness-43 to 58) Hot drop forged
For (Speculums, Retractors)	Stainless steel Sheet-300 Series 18/8 (18% Chromium & 8% Nickel)

#### **Please Note:**

The delicate, hand-crafted surgical instrument use only for its intended purpose to Ensure effectiveness and maximum life. Proper care must be given during cleaning, sharpening and sterilization to preserve design and integrity and to prolong usefulness. Do not expose instruments to sterilization temperatures above 350 F/177°C or to higher than recommended chemical concentrations. "Longer Life for Surgical Instrument" for proper cleaning, sterilization and other instrument care.

**Inspected the instrument after each use for:** pitting; corrosion; discoloration; broken, loose or bent components; cracked handles; dull cutting edges; over sharpened or worn out blades; chipped or peeled plating; damaged hinges, beaks or blades. Instruments found to Have these or other compromising conditions should be removed from service.



**fairmount**

**INDUSTRIES (PVT) LTD.**

**"Fairmount"** Stand for Customers Total Satisfaction.

## **Surgical Instruments Catalogue**

We feel immense pleasure to present our latest catalogues in which we have featured a most comprehensive range of all quality Surgical Instruments required for day-to-day use for Surgeons, Operating Room, Nurses Central Supply Clinics, Floor Use, Emergency Rooms, Professional and other Members of the Surgical-Care Team. Without their loyalty, support and steady flow of innovative ideas, we would not be marking this momentous occasion.

We will be pleased to quote you a competitive Price and Delivery time.

All instruments are manufactured according to the recognized standard patterns currently in use in Hospitals Clinics throughout the world and are being produced under restrict control of experts to avoid any flow and to refrain any complaint at any stage.

A group of very vast experienced persons in manufacturing handling our quality Control System.

Any instruments proven defective in workmanship or material will be replaced with out charges.

We express our thanks to all our customers for the confidence they have placed us in the past. We further assure them that we will continue our best efforts to gain their confidence in the future.



## we at about the **FAIRMOUNT INDUSTRIES (PVT) LTD.**

**Fairmount Industries ( Pvt ) Ltd.** established in 1958 and was based on ideology of the word "FAIR" which we used for fair dealing in every aspect of business just to establish and promote our business. It was period of manual skill used for the quality production according to the requirements of our worthy Manufacturers-cum-importers buyers.

During the past (57) years we kept to maintain the standard of our instruments and we successfully promoted our business to a remarkable target, so in 1997 we in the mechanical age qualified for cG.M.P (F.D.A) U.S.A. whereas we attained the status of international quality standard of DIN EN, ISO-9001:2008, ISO-13485-2003, by Q.A International, U.K which assisted us to improve our Instruments quality. We also attained the CE. Marking certificate in 1998 from Medical Devices Agency.

We express our thanks to our entire customers for the confidence they have placed in us in the past. We further assure them, that we will continue our best efforts to gain their confidence in the future.





# **fairmount**

## **INDUSTRIES (PVT) LTD.**

**"fairmount" Stand for Customers Total Satisfaction.**

*Manufacturers & Exporters of Surgical, Dental Instruments & Scissors All Sorts*

*Nizam Street, Kotli Behram, Sialkot-51330, Pakistan*

*Tel: +92-52-4263082, 4263582 Fax: +92-52-4264782, 4263162*

*Mob: +92-300-8710140*

*E-mail: fair@brain.net.pk info@fair-mount.com*

*www.fair-mount.com*

CERTIFIED  
DIN EN ISO 9001:2008  
ISO - 13485:2012



cGMP  
CERTIFIED



# DIAGNOSTIC INSTRUMENTS





## STETHOSCOPES

Stethoskope | Estetoscopics  
Stéthoscopes | Stetoscopi



**DUPLEX, Stethoscope**  
F1-001  
super lightweight



**DUPLEX-BABY**  
Stethoscope  
F1-002  
super lightweight



**ANAESTHOPHON**  
Stethoscope  
F1-003  
super lightweight



**PINARD WOODEN**  
Stethoscope  
F1-004  
10 cm, 7"



**PINARD ALUMINUM**  
Stethoscope  
F1-005  
15 cm, 6"



**WEBER**  
Auscultometer  
F1-006  
9.0 cm, 3 1/2"



**NEURO-DUOFLEX Hammer**  
F1-007 22 cm, 8 3/4"



**DEJERINE Hammer**  
F1-008 20 cm, 8"



**DEJERINE Hammer**  
F1-009 20 cm, 8"



**TROEMNER Hammer**  
F1-010 145 g  
F1-011 175 g  
F1-012 235 g  
24.5 cm, 9 1/2"  
spare rubber



**TROEMNER-SIMPLEX Hammer**  
F1-013 21 cm, 8 1/4"



**BUCK Hammer**  
F1-014 13.5 cm, 7 1/4"



**BUCK Hammer**  
F1-015 13 cm, 7"



**TAYLOR Hammer**  
F1-016 18 cm, 7"  
F1-017 20 cm, 8"



**TAYLOR Hammer**  
F1-018 18 cm, 7"



**BABINSKY Hammer**  
**F1-019** 22 cm, 8 3/4"  
 Ø 40mm

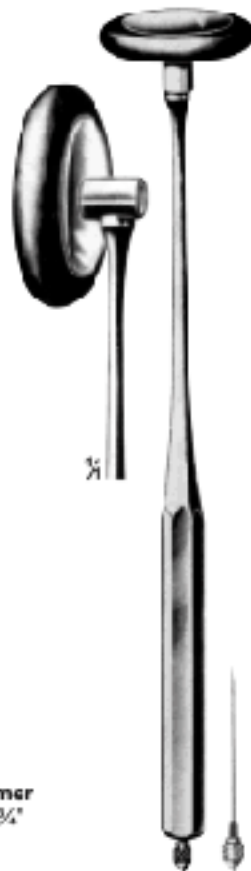

**BABINSKY Hammer**  
**F1-020** 22 cm, 8 3/4"  
 Ø 40mm



**RABINER Hammer**  
**F1-021** 23 cm, 9"  
 Ø 40mm  
 with needle & brush



**BERLINER Hammer**  
**F1-022** 20.0 cm, 8"



**TRAUBE Hammer**  
**F1-023** 16 cm, 6 1/4"



**WARTENBERG Pinwheel**  
**F1-024** 19 cm, 7 1/2"



**MAGILL**  
 Catheter Intubating  
 Forcep  
**F1-025** 18 cm, 6 1/4"



**MAGILL**  
 Catheter Intubating  
 Forcep  
**F1-026** 20 cm, 8"



**MAGILL**  
 Catheter Intubating  
 Forcep  
**F1-027** 25 cm, 10"



**MAGILL Catheter Intubating Forcep GOLD**  
**F1-028** 6.5" (2.5" shaft), Infant, hole (dia 2.00 mm)  
**F1-029** 7.5" (3" shaft), Infant, hole (dia 2.30 mm)  
**F1-030** 7.5" (4" shaft), Infant, hole (dia 2.30 mm)



**MAGILL Catheter Intubating Forcep GOLD**  
**F1-031** 8" (4" shaft), Child, hole (dia 3.00 mm)  
**F1-032** 8" (4" shaft), Child, oval tip (5.38 mm X 4.15 mm)  
**F1-033** 9" (5" shaft), Adult, oval (6.80 mm x 5.00 mm)  
**F1-034** 10" (5" shaft), Adult, oval (9.60 mm x 7.70 mm)

## MC-INTOSH FIBER OPTIC LARYNGOSCOPE BLADE (English Pattern)

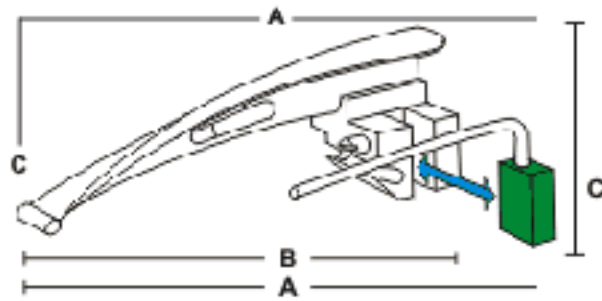

**BLADE**

Size	A	B	C	Working Length
0	77mm	53mm	14mm	55mm
1	95mm	72mm	43mm	70mm
2	111mm	86mm	44mm	78mm
3	133mm	109mm	44mm	108mm
4	151mm	129mm	44mm	133mm

### Mc-Intosh Laryngoscope Fiber Optic

Halogen illumination. Manufactured from AISI 304 Stainless-Steel. Halogen illumination 2.5 v. The Bulb is inside the handle in order to simplify the sterilization of the blades. All blades and handles are interchangeable with other leading manufacturer. All sets can be combined as per your request, and delivered in Green plastic case.

#### Blade Availability:

- ✦ Matt Finish
- ✦ Mirror Finish
- ✦ Sand Blast Finish
- ✦ Pls, confirm in your order list



Laryngoscope Battery  
Handle for Adult  
C type 2 batteries

## MC-INTOSH FIBER OPTIC LARYNGOSCOPE SET HALOGEN ILLUMINATION

**F1-035  
PEDIATRIC SET**  
Set of 0,1,2  
Blades  
Supplied in  
Green plastic case

**F1-036  
STANDARD SET**  
Set of 1,2,3  
Blades  
Supplied in  
Green plastic case

**F1-037  
ADULT SET**  
Set of 1,2,3,4  
Blades  
Supplied in  
Green plastic case

Fig. C

Fig. 1

Fig. 2

Fig. 3

Fig. 4



Mc-Intosh Fiber Optic Laryngoscope Set  
Halogen Illumination  
Manufactured by AISI:  
304 Stainless Steel Material

## MC-INTOSH LARYNGOSCOPE

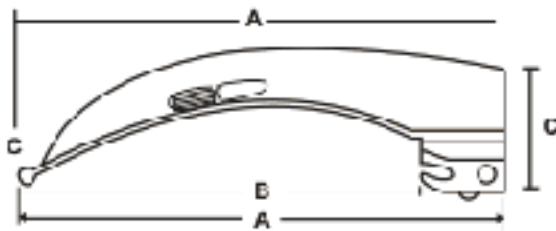

### BLADE

Size	A	B	C	Working Length
0	30mm	50mm	30mm	55mm
1	97mm	76mm	36mm	70mm
2	111mm	88mm	36mm	78mm
3	133mm	112mm	36mm	108mm
4	154mm	131mm	38mm	133mm

### Mc Intosh Laryngoscope

Plastic case, Standard illumination. Manufactured from AISI 304 Stainless Steel Matt Type, Standard Illumination 2.5 V. All blades and handles are interchangeable with other leading manufacturer. All sets can be combined as per your request, and delivered in Gray plastic case.

#### Blades Availability:

- \* *Mat Finish*
- \* *Mirror Finish*
- \* *Sand Blast Finish*
- \* *Pls, confirm in your order list*



Laryngoscope Battery Handle for Adult  
C type 2 Batteries



With two Spare Bulbs

## Conventional Laryngoscope Set

### MC-INTOSH LARYNGOSCOPE SET STANDARD ILLUMINATION

AVAILABLE SETS WITH BATTERY HANDLE

#### F1-438 PEDIATRIC SET

Set of 0,1,2  
Blades  
Supplied in Gray plastic case

#### F1-439 STANDARD SET

Set of 1,2,3  
Blades  
Supplied in Gray plastic case

#### F1-440 ADULT SET

Set of 1,2,3,4  
Blades  
Supplied in Gray plastic case



Fig. 0



Fig. 1



Fig. 2



Fig. 3

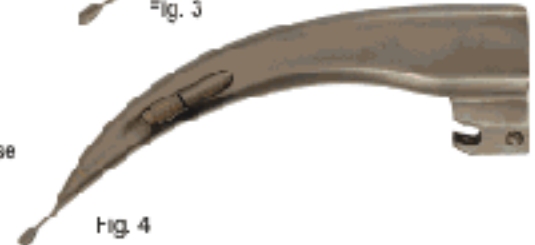

Fig. 4



Mc-Intosh Laryngoscope Set  
Standard Illumination  
Manufactured From  
Stainless Steel Material



## LARYNGOSCOPE MILLER

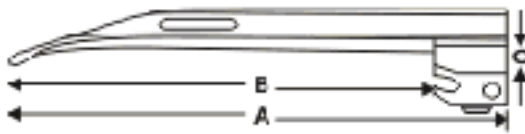

BLADE

Size	A	B	C	Working Length
0	75mm	53mm	26mm	55mm
1	111mm	80mm	26mm	60mm
2	151mm	104mm	20mm	100mm
3	188mm	167mm	28mm	170mm
4	203mm	180mm	28mm	180mm

### McIntosh Laryngoscope

Plastic case, Standard illumination.

Manufactured from AISI 304 Stainless Steel.

All blades and handles are interchangeable

with other leading manufacturer. All sets

can be combined as per your request, and

delivered in Blue plastic case.

#### Blade Availability:

- ★ Mat Finish
- ★ Mirror Finish
- ★ Sand Blast Finish
- ★ Pls, confirm in your order list

## Conventional Laryngoscope Set

### LARYNGOSCOPE SET OF CONVENTIONAL MILLER STANDARD ILLUMINATION

AVAILABLE SETS  
WIT-1  
BATTERY HANDLE



Fig. 1

F1-041  
PEDIATRIC SET  
Set of 0,1,2  
Blades  
Supplied in  
Blue plastic case



Fig. 2

F1-042  
STANDARD SET  
Set of 1,2,3  
Blades  
Supplied in  
Blue plastic case



Fig. 3

F1-043  
ADULT SET  
Set of 1,2,3,4  
Blades  
Supplied in  
Blue plastic case



Fig. 4



Laryngoscope Battery handle for Adult C type  
2 batteries



With two Spare Bulbs



Laryngoscope Set of conventional Miller Standard Illumination  
Manufactured From Stainless Steel Material



## DIAGNOSTIC SETS

<i>Diagnostik-Besetzstecke</i>	<i>Juegos para diagnóstico</i>
<i>Trousses à diagnostic</i>	<i>Astucci per diagnostica</i>



**Professional Otolaryngology & Ophthalmology Set  
ENT Medical Diagnostic Set**

### F1-044

2.5 V Standard illumination for use with 2 batteries C type.

Including:

Otoscope Head: Luir Lock fitting.  
Chrome plated.

Fix lens 4 x in plastic mount can be removed for introduction of instruments.

Specula sizes: 2.5, 3.5 & 4.5 mm Included,  
Ophthalmoscope head: Luir Lock fitting.

Lens selection wheel permits choice of corrective lenses from 0 to -20 and 0 to +20 diopters.

Single large circle aperture.

Bent-arm illuminator: pin contact fitting.

Nasal speculum: Chrome plated.

Two laryngeal mirrors: n. 4 and 5.

Battery handle: 28mm. For 2 cell C-batteries.

Chrome plated. For adjustment of all illumination.

Replacement bulb: 2.5 V

Diagnostic set is supplied in our new beautiful look and quality Blue Case, which protect our quality Products from molarizing and damaging.



Handle



Two laryngeal mirrors: n. 4 and 5



Bent-arm illuminator:  
pin contact fitting.



Specula



With 2 spare Bulbs



Otoscope Head



Nasal speculum: Chrome plated



Ophthalmoscope head



FNT Specula

**DIAGNOSTIC PENTOSCOPE SET**
**F1-045**

2.5 V Standard Illumination for use with 2 batteries type AA.

Consisting:

Universal Handle thread type fit for all Pentoscope Heads like.

- Otscope Head.
- Ophthalmoscope Head.
- Throat Branch Head.
- Mouth Mirrors Head.

It have two exploring mirrors No. 4 &amp; 5 mm its spare 06 disposable Plastic ear Canulas are with sizes 2 x 2.50 mm 2 x 3.50 mm &amp; 2 x 4.5 mm. On special order it can be as 2 x 1.5 mm for newborn babies 2 x 2.5 mm for pediatric and 2 x 4 mm for adults, so it means total 06 canula also available in a plastic tube packing.

Sturdy adjustment mount bracket

2 spare 2.5 V bulb.

Pentoscope set battery handle is operating with two AA size bateres.

This Pentoscope set Packed in our new beautiful Blue Colour plastic case in same blue inner packing material

Spare parts also available of any item.



With 2 spare BULBS



Mouth Mirrors Head



Standard Illuminator



Otscope Head



Sturdy Adjustment Mount Bracket

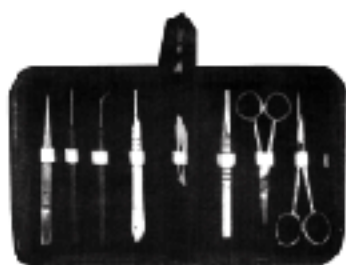

Plastic ear Canulas

**F1-046**

Dissecting Set of 9 Pcs

- Dissecting Forceps 11.5cm Sharp Point.
- Teasing Needle Sharp STR.
- Teasing Needle Sharp Angular.
- D.P I handle No.4.
- Blade No. 22.
- Thumb Forcep T.C.E 13cm.
- Dissecting Scissor STR 11.5cm.
- Dissecting Scissor STR 13cm.
- Zipper Case Inside Red Velvet.

**F1-047**

Dissecting Set of 10 Pcs.

- Grooved Director with Tongue Tie 14cm.
- Probe Double 14cm.
- Mayo Hegar Needle Holder 14cm.
- D.P I handle No.3
- D.P I handle No.4
- Dressing Scissor 14cm S/B STR.
- Dressing Scissor 14cm S/B CVD
- Dressing Forcep 1x2 teeth 14cm.
- Dressing Forcep Serrated 14cm.
- Zipper Case Inside Red Velvet

**F1-048**

Dissecting Set of 10 Pcs.

- Probe Double 13cm.
- 2PCS Scalpel S.S.
- Grooved Director With Tongue Tie 14cm
- Mayo Hegar Needle Holder 14cm.
- Dissecting Forceps 14cm 1x2 Teeth
- Dressing Forceps 14cm Serrated.
- Dressing Scissor 14cm S/B STR.
- Dressing Scissor 14cm S/B CVD.
- Zipper Case Inside Red Velvet.



**F1-049**

Dissecting Set of 10 Pcs.

- Blow Pipe.
- 3PCS Scalpel.
- Dissecting Forceps 14cm.
- Grooved Director With Tongue Tie 14cm
- Triple Chain Hook.
- Dressing Scissor Probe Pointed 14cm.
- Probe Double 14 cm.
- Zipper Case Inside Red Velvet.

**Dissecting Set**
**F1-050** Containing 9 Instruments

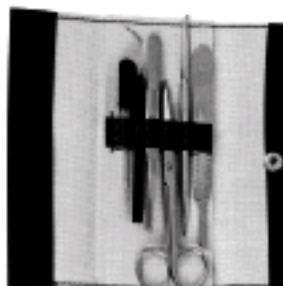
- Slice Needle
- Probe Butterfly
- Needle Holder
- Scalpel Handle 3
- Scalpel Handle 4
- Dressing Forceps
- Tissue Forceps
- Tissue Scissors
- Dressing Scissors

**F1-051**

Dissecting Set of 6 pcs.

- Dropper Oil
- Probe Plastic Handle
- Dressing Forceps
- Dressing Scissors S/S
- Hook
- Scalpel Handle 4



**F1-052**

Dissecting Set of 12 pcs.

- Iris Scissors
- Scalpel Knives 4
- Probe Single Ended
- Scalpel Handle 3
- Dressing Scissors S/S
- Dressing Scissors S/B
- Dressing Forceps
- Colgate Tweezer
- Probe Straight Plastic Handle
- Probe Angular Plastic Handle
- Dropper Owl
- Hook

**F1-053**

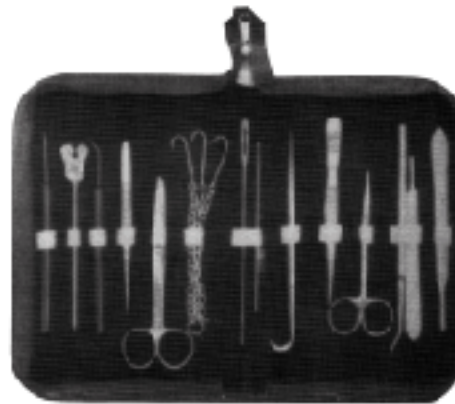
- 1 Probe with eye
- 2 Dissecting Forcep CVD Fine 12 cm.
- 3 Iris Scissor
- 4 Operating Scissor S/B STR 14 cm
- 5 Grooved Director and Tongue tie
- 6 Huber Probe
- 7 Triplo Chain Hook
- 8 B.P. Handle No. 4
- 9 B.P. Handle No. 3
- 10 Teasing Needle with Chuck CVD.
- 11- Teasing Needle with Chuck STR
- 12- Dissecting Forceps Fine 14 cm.

**F1-054**

- 1 Teasing Needle STR.
- 2 Grooved Director and Tongue Tie.
- 3 Teasing Needle CVD.
- 4 Dissecting Forcep with Pin 12 cm Fine
- 5 Operating Scissor S/B STR 14 cm
- 6 Triplo Chain Hook
- 7 Probe with eye
- 8 Probe Double end
- 9 Probe and Hook
- 10 Dissecting Forcep Fine 14 cm
- 11- Iris Scissor
- 12- Huber Probe
- 13- B.P. Handle No.3
- 14- B.P. Handle No.4

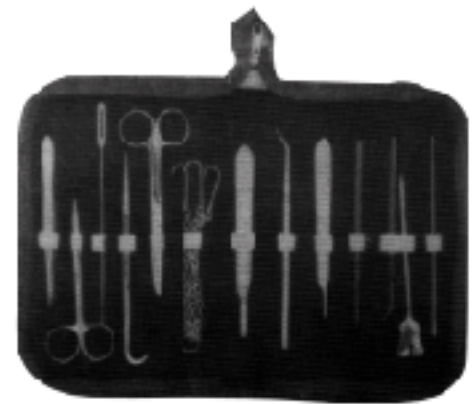
**F1-055**

- 1 Dissecting Forcep Fine STR with pin 12cm.
- 2 Iris Scissor STR
- 3 Probe with eye.
- 4 Probe and Hook
- 5 Operating Scissor S/B STR 14cm
- 6 Triplo Chain Hook.
- 7 B.P. Handle No.4
- 8 Huber Probe.
- 9 B.P. Handle No.3
- 10 Teasing Needle STR Plastic Handle.
- 11- Teasing Needle CVD Plastic Handle.
- 12- Grooved Director and Tongue Tie.
- 13- Probe Double end.

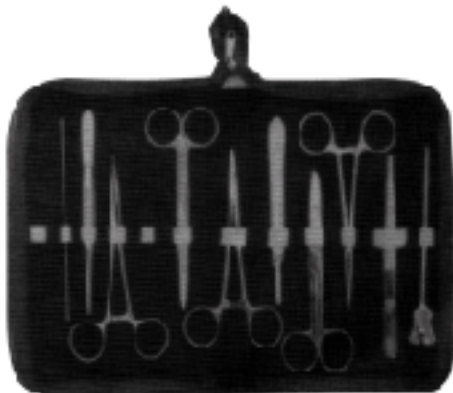
**F1-066**

- 1 Dissecting Forceps Thumb 14 cm.
- 2 Dissecting Forcep 1x2 Teeth 14 cm.
- 3 B.P. Handle No. 3
- 4 Grooved Director and Tongue tie
- 5 Mayo Hagar Needle Holder 14 cm
- 6 Operating Scissor S/B STR 14 cm
- 7 Probe Double end
- 8- Kelly Forcep STR 14 cm.

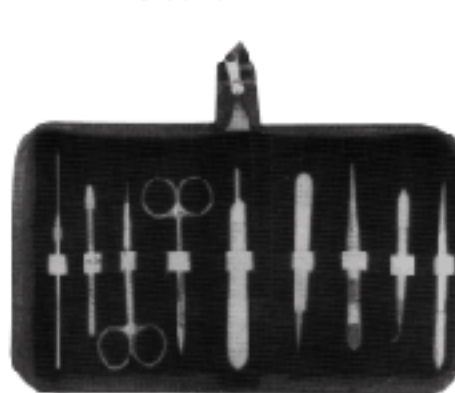
**F1-057**

- 1 Dissecting Forcep Fine 14cm.
- 2 Dissecting Forcep Fine CVD 12cm
- 3 Dissecting Forcep with Pin 14cm.
- 4 Watchmaker Fine point
- 5 Iris Scissor STR
- 6 Iris Scissor CVD
- 7 Teasing Needle Holder
- 8- Teasing Needle STR.
- 9- B.P. Handle no. 3

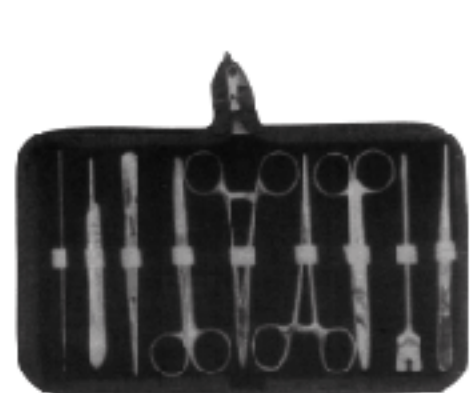
**F1-068**

- 1 Probe Double end
- 2 B.P. Handle No. 4
- 3 Dissecting Forcep 1x2 Teeth 14 cm.
- 4 Operating Scissor S/B STR 14 cm
- 5 Mayo Hagar Needle Holder 14 cm
- 6 Kelly Forcep STR 14 cm.
- 7 Operating Scissor S/B CVD 14 cm
- 8- Grooved Director and Tongue tie
- 9- Dissecting Forceps Thumb 14 cm.

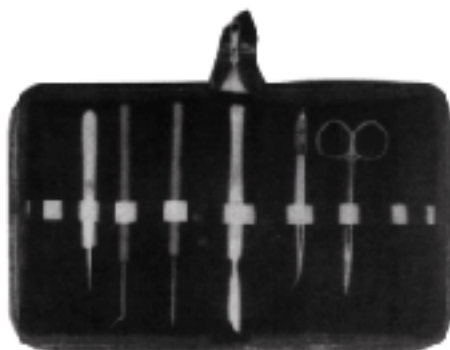
**F1-059**

- 1- Iris Scissor STR
- 2- Dissecting Forceps CVD 12 cm.
- 3- Scapel
- 4- Teasing Needle STR wooden handle
- 5- Teasing Needle CVD wooden handle.
- 6- Watchmaker fine point.

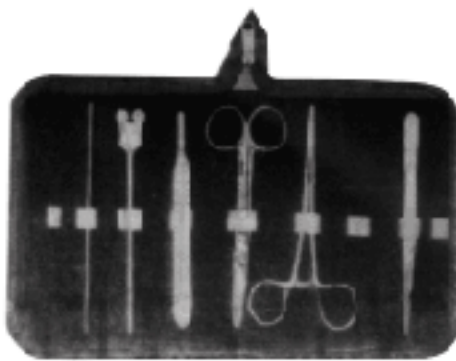
**F1-060**

- 1- Probe Double end.
- 2- Grooved Director and Tongue tie
- 3- B.P. Handle No. 4
- 4- Operating Scissor STR S/B 14 cm.
- 5- Kelly Forceps STR 14 cm.
- 6- Dissecting Forceps Thumb 13 cm.

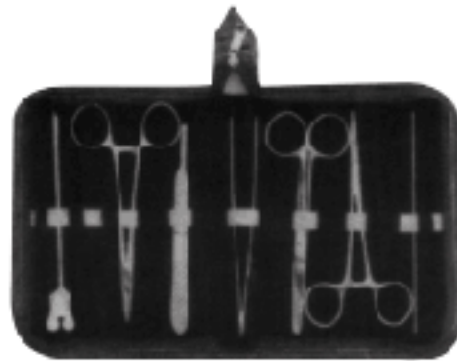
**F1-061**

- 1- Grooved Director and Tongue tie
- 2- Mayo Hagar Needle Holder 14 cm
- 3- B.P. Handle No. 4
- 4- Dissecting Forceps Thumb 14 cm.
- 5- Operating Scissor G/D STR 14 cm
- 6- Kelly Forcep STR 14 cm.
- 7- Probe Double end

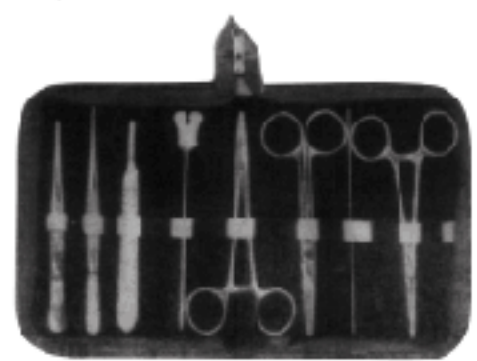
**F1-062**

- 1- Dissecting Forceps Thumb 14 cm
- 2- Dissecting Forcep 1x2 Teeth 14 cm
- 3- B.P. Handle No. 3
- 4- Grooved Director and Tongue tie
- 5- Mayo Hagar Needle Holder 14 cm
- 6- Operating Scissor S/B STR 14 cm
- 7- Probe Double end
- 8- Kelly Forcep STR 14 cm.

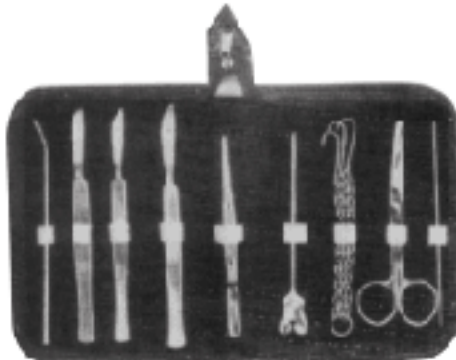
**F1-063**

- 1- Blow pipe.
- 2- 3 PCS Scalpel
- 3- Dissecting Forcep 13 cm.
- 4- Grooved Director with Tongue tie 13 cm
- 5- Triple Chain Hook.
- 6- Dressing Scissors probe pointed 13 cm.
- 7- Probe Double 13 cm.
- 8- Zipper Case Inside Red Velvet

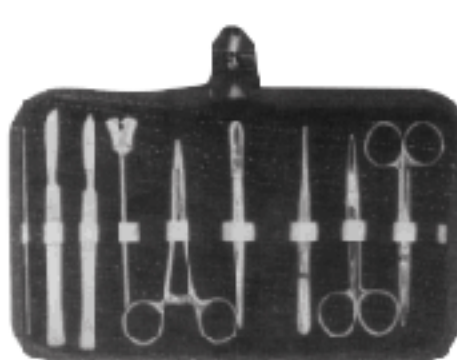
**F1-064**

- 1- Probe Double 13 cm
- 2- 2 PCS. Scalpel S.S
- 3- Grooved Director with Tongue Tie 13 cm
- 4- Mayo Hagar Needle Holder 13 cm
- 5- Dissecting Forcep 13 cm 1x2 Teeth
- 6- Dressing Forcep 13 CMS Serrated.
- 7- Dressing Scissor 13 cm S/B STR.
- 8- Dressing Scissor 13 cm S/R CVD
- 9- Zipper Case Inside Red Velvet

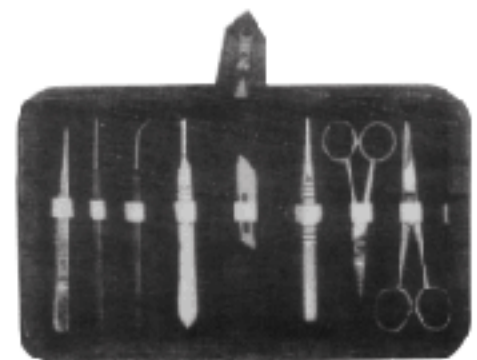
**F1-065**

- 1- Dissecting Forcep 11.5 cm Sharp Point
- 2- Iris Scissor
- 3- B.P. Handle No. 4
- 4- Teasing Needle Sharp angular.
- 5- Blade No. 22
- 6- Thumb Forceps T.O.E 13 cm
- 7- Dissecting Scissor STR 11.5 cm
- 8- Dissecting Scissor STR 13 cm
- 9- Zipper case Inside Red Velvet

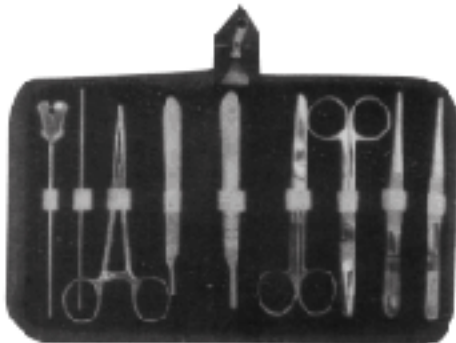
**F1-066**

- 1- Grooved Director with Tongue Tie 14 cm
- 2- Probe Double 14 cm
- 3- Mayo Hagar Needle Holder 14 cm
- 4- B.P. Handle No. 3
- 5- B.P. Handle No. 4
- 6- Dressing Scissor 14 cm S/B STR
- 7- Dressing Scissor 14 cm S/B CVD.
- 8- Dressing Forcep 1x2 Teeth 14 cm
- 9- Dressing Forcep Serrated 14 cm

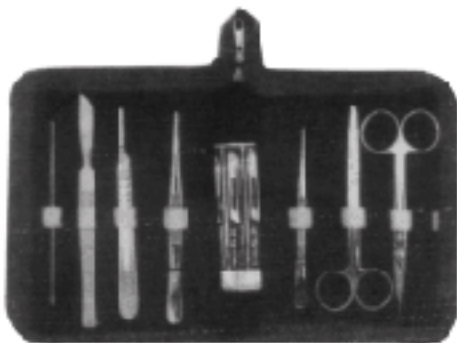
**F1-067**

- 1- Probe Double 12.5 cm
- 2- Scalpel
- 3- B.P. Handle No. 4
- 4- 6 PCS Blade 2 Each Nc. 21, 22, 23
- 5- Dissecting Forcep 12.5 cm
- 6- Dissecting Forcep 11.5 cm Sharp Point
- 7- Dissecting Scissor S/B STR 13 cm
- 8- Dissecting Scissor S/S STR 13 cm

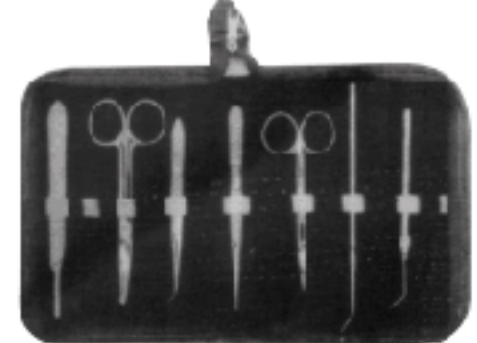
**F1-068**

- 1- Teasing Needle with Chuck CVD.
- 2- Huber Probe
- 3- Iris Scissor
- 4- Dissecting Forcep Fine 14 cm.
- 5- Dissecting Forcep Fine CVD. 12 cm
- 6- Operating Scissor with Probe 14 cm
- 7- B.P. Handle No. 4



**F1-069**  
 15 cm, 5"  
 cm & mm  
 markings

**GRADUATED  
 METAL RULER**



**JAMESON  
 CALIPER**  
**F1-070**  
 8 cm, 3"



**TOWNLEY  
 CALIPER**  
**F1-071**  
 10 cm, 4"



**MÖELTGEN  
 CALIPER**  
**F1-072**



**CAROLL  
 POCKET GONIOMETER**  
**F1-073**  
 14.5 cm, 5 7/8"



**BERTILLON  
 MEASURING DEVICE**  
**F1-074**  
 32cm 12 1/2"



**VERNIER CALIPER**  
**F1-075**  
 15 cm, 6"



**VERNIER CALIPER**  
**F1-076**  
 15 cm, 6"  
 Fine Point



**CASTROVIEJO-EPKER**  
**Caliper**  
**F1-077** 9 cm, 3 1/2", Str.  
 Measuring range, 40 mm  
**F1-078** 9 cm, 3 1/2", Cvd.  
 Measuring range, 40 mm



**CASTROVIEJO-EPKER**  
**Caliper**  
**F1-079**  
 18 cm, 7"  
 Measuring range  
 40 mm, straight



**CASTROVIEJO-EPKER**  
**Caliper**  
**F1-080**  
 18 cm, 7" Angled  
 Measuring range  
 40 mm



**CASTROVIEJO**  
**F1-031**  
 Bone Caliper 7"  
 Straight:



**CASTROVIEJO**  
**F1-082**  
 Bone Caliper 7"  
 Curved



**CASTROVIEJO, Left**  
**F1-083** 8 cm, 3", Str.  
 Eye view Caliper  
 Measuring range 20 mm  
**F1-084** 8 cm, 3", Cvd.  
 Measuring range 20 mm



**CASTROVIEJO, Right**  
**F1-085**  
 8 cm, 3"  
 Eye View Caliper  
 Measuring range  
 20 mm





# TROCARS, SUCTION TUBES & CANNULAS

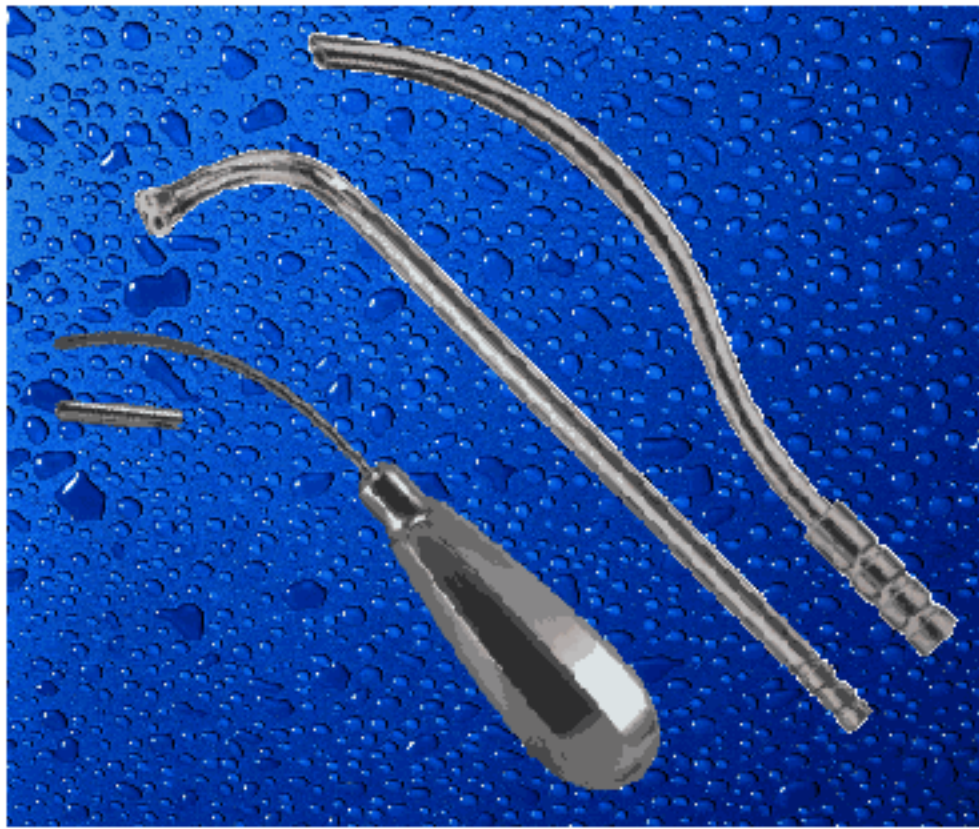
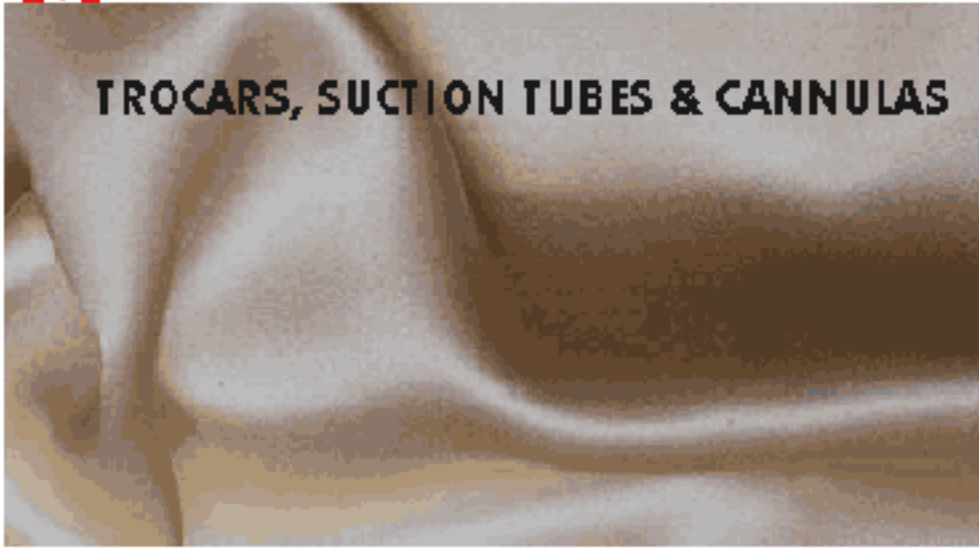



Cap Only

Fig. 1 F2-003 1.7 mm Ø	Fig. 2 F2-004 3 mm Ø	Fig. 3 F2-005 4.5 mm Ø	Fig. 4 F2-006 6 mm Ø
------------------------------	----------------------------	------------------------------	----------------------------

**UNIVERSAL** Abdominal Trocar Set  
F2-001  
(Handle with 4 needles) 14 cm, 5 1/2"  
Fig. 1.7 mm Ø to 6 mm Ø  
F2-002  
Only Handle

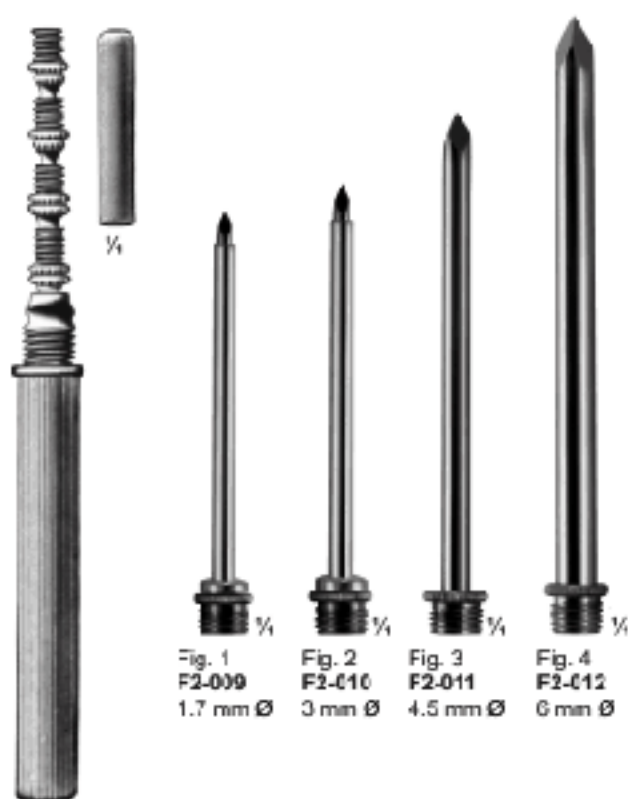

1/4"

Fig. 1 F2-009 1.7 mm Ø	Fig. 2 F2-010 3 mm Ø	Fig. 3 F2-011 4.5 mm Ø	Fig. 4 F2-012 6 mm Ø
------------------------------	----------------------------	------------------------------	----------------------------

**UNIVERSAL** Abdominal Trocar Set  
F2-007  
(Handle with 4 needles) 14 cm, 5 1/2"  
Fig. 1.7 mm Ø to 6 mm Ø  
F2-008  
Only Handle



**LUER**, Trocar  
F2-013  
Luer Lock Adapter



**UCKERMANN**, Trocar  
F2-014  
130 cm 5"



**SINUSCOPY**, Trocar  
17.0 cm 6 3/4"

3.5 mm Ø  
F2-015

5.0 mm Ø  
F2-016

5.0 mm Ø  
F2-017



Complete  
**F2-010** 1.0 mm Ø  
**F2-018** 2.0 mm Ø

**LIGHTWITZ**  
 Antrum Trocar  
 19 cm, 7 1/2"



- F2-020** 3 1/3 mm Ø
- F2-021** 4 mm Ø
- F2-022** 4 2/3 mm Ø
- F2-023** 5 1/3 mm Ø
- F2-024** 6 mm Ø
- F2-025** 5 2/3 mm Ø
- F2-026** 7 1/3 mm Ø
- F2-027** 8 mm Ø
- F2-028** 9 2/3 mm Ø
- F2-029** 9 1/3 mm Ø

**OCHSNER**  
 Trocar T to ax  
 10.0 cm 4"



**NELSON**  
 Trocar T to ax  
 21.0 cm 8 1/4"

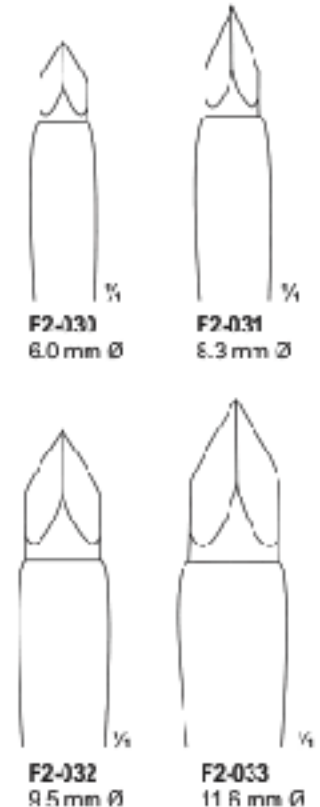

**F2-031**  
 6.0 mm Ø

**F2-031**  
 8.3 mm Ø

**F2-032**  
 9.5 mm Ø

**F2-033**  
 11.6 mm Ø



**LANDAU, Trocar**  
**F2-034** 2.0 mm Ø  
 16 cm 6 1/4"



**PIERCE**  
 Antrum Trocar  
 17.0 cm 6 3/4"

- F2-035** 3.0 mm Ø
- F2-036** 4.0 mm Ø
- F2-037** 5.0 mm Ø



**KRAUSE, Trocar**  
**F2-030** 15.0 cm Ø  
 5.5 mm Ø



**COAKLEY, Trocar**  
**F2-038** 16.0 cm 6 1/4"  
 2.25 mm Ø



**ADSON**  
Suction Tubes  
**F2-040**  
4 mm Ø  
15 cm, 6"



**ADSON**  
Suction Tubes  
21.0 cm 8 1/4"  
**F2-041** 4 mm Ø 12 Charr./Fr.  
**F2-042** 5 mm Ø 15 Charr./Fr.



**PLESTER**  
Suction Tubes  
17.0 cm 6 3/4"

- |               |            |               |
|---------------|------------|---------------|
| <b>F2-043</b> | 2 mm Ø     | 5 Charr./Fr.  |
| <b>F2-044</b> | 2 1/3 mm Ø | 7 Charr./Fr.  |
| <b>F2-045</b> | 2 2/3 mm Ø | 8 Charr./Fr.  |
| <b>F2-046</b> | 3 mm Ø     | 9 Charr./Fr.  |
| <b>F2-047</b> | 3 1/3 mm Ø | 10 Charr./Fr. |
| <b>F2-048</b> | 3 2/3 mm Ø | 11 Charr./Fr. |
| <b>F2-049</b> | 4 mm Ø     | 12 Charr./Fr. |
| <b>F2-050</b> | 5 mm Ø     | 15 Charr./Fr. |



**FERGUSSON**  
Suction Tubes  
17.0 cm 6 3/4"

- |               |            |               |
|---------------|------------|---------------|
| <b>F2-051</b> | 2 mm Ø     | 6 Charr./Fr.  |
| <b>F2-052</b> | 2 1/3 mm Ø | 7 Charr./Fr.  |
| <b>F2-053</b> | 2 2/3 mm Ø | 8 Charr./Fr.  |
| <b>F2-054</b> | 3 mm Ø     | 9 Charr./Fr.  |
| <b>F2-055</b> | 3 1/3 mm Ø | 10 Charr./Fr. |
| <b>F2-056</b> | 3 2/3 mm Ø | 11 Charr./Fr. |
| <b>F2-057</b> | 4 mm Ø     | 12 Charr./Fr. |
| <b>F2-058</b> | 5 mm Ø     | 15 Charr./Fr. |



**Yankauer**  
suction tube  
**F2-059**  
27.0 cm, 10 1/2"



**FRAZIER**  
Suction Tubes  
**F2-060** 6 Fr.  
**F2-061** 7 Fr.  
**F2-062** 9 Fr.  
**F2-063** 1' Fr.  
19 cm, 7 1/2"

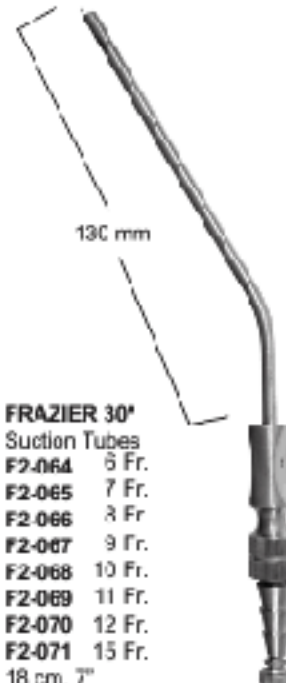

**FRAZIER 30°**  
Suction Tubes  
**F2-064** 6 Fr.  
**F2-065** 7 Fr.  
**F2-066** 8 Fr.  
**F2-067** 9 Fr.  
**F2-068** 10 Fr.  
**F2-069** 11 Fr.  
**F2-070** 12 Fr.  
**F2-071** 15 Fr.  
18 cm, 7"



**FRAZIER 45°**  
Suction Tubes  
**F2-072** 6 Fr.  
**F2-073** 7 Fr.  
**F2-074** 8 Fr.  
**F2-075** 9 Fr.  
**F2-076** 10 Fr.  
**F2-077** 11 Fr.  
**F2-078** 12 Fr.  
18 cm, 7"



**HARTMANN**  
Eustachian Catheters  
Fig. 1  
F2-079 2.0 mm Ø  
F2-080 2.5 mm Ø  
F2-081 3.0 mm Ø



**HARTMANN**  
Eustachian Catheters  
Fig. 2  
F2-082 2.0 mm Ø  
F2-083 2.5 mm Ø  
F2-084 3.0 mm Ø



**KILLIAN**, Eustachian Catheters  
F2-085 16.0 cm 6" 2.5 mm Ø  
F2-086 16.0 cm 6" 3.0 mm Ø  
oval opening



Fig. 0  
F2-087

Fig. 2  
F2-089

Fig. 4  
F2-091

**HARTMANN**  
Eustachian Catheters  
15.0 cm 6"

Fig. 1  
F2-088

Fig. 3  
F2-090

Fig. 5  
F2-092



**TRÖLTSCH**  
Eustachian Catheters  
15.0 cm 6"

F2-093  
Tube end piece  
for eustachian  
catheter

F2-093  
Tube end piece  
for eustachian  
catheter

Fig. 2  
F2-095

Fig. 4  
F2-097

Fig. 1  
F2-094

Fig. 3  
F2-096

Fig. 5  
F2-098



**ZOLLNER** Suction Tube  
**F2-099** 0.7 mm Ø  
 complete with 1 slip-on  
 cannula, 0.7 mm Ø



**IOWA** Suction Tube  
**F2-100** 0.7 mm Ø  
 16.0 cm 6 1/4"



**MAGILL** Suction Tube  
 24.5 cm 9 3/4"  
**F2-101** 3.0 mm Ø  
**F2-102** 3.5 mm Ø  
**F2-103** 4.0 mm Ø



**ROSEN** Suction Tube  
 X=80 mm  
**F2-104** 0.7 mm Ø  
**F2-105** 0.9 mm Ø  
**F2-106** 1.2 mm Ø



**ROSEN** Suction Tube  
 X=65 mm  
**F2-107** 0.7 mm Ø  
**F2-108** 0.9 mm Ø  
**F2-109** 1.2 mm Ø



**SUCTION TUBE, Guide Needle**  
 19.5 cm 5 3/4"  
**F2-110** 2.2/3 mm Ø 8 Charr./Fr.  
**F2-111** 3.1/3 mm Ø 10 Charr./Fr.  
**F2-112** 4 mm Ø 12 Charr./Fr.  
**F2-113** 4 2/3 mm Ø 14 Charr./Fr.  
**F2-114** 5 1/3 mm Ø 16 Charr./Fr.  
**F2-115** 6 mm Ø 18 Charr./Fr.



**SUCTION TUBE, Guide Needle**  
 19.5 cm 5 3/4"  
**F2-116** 2 mm Ø 6 Charr./Fr.  
**F2-117** 2.2/3 mm Ø 8 Charr./Fr.  
**F2-118** 3 1/3 mm Ø 10 Charr./Fr.  
**F2-119** 4 mm Ø 12 Charr./Fr.  
**F2-120** 4 2/3 mm Ø 14 Charr./Fr.  
**F2-121** 5 1/3 mm Ø 16 Charr./Fr.  
**F2-122** 6 1/3 mm Ø 18 Charr./Fr.



**SUCTION TUBE, Guide Needle**  
**Lancet Tip** 19.5 cm 5 3/4"  
**F2-123** 2.2/3 mm Ø 8 Charr./Fr.  
**F2-124** 3.1/3 mm Ø 10 Charr./Fr.  
**F2-125** 4 mm Ø 12 Charr./Fr.  
**F2-126** 4 2/3 mm Ø 14 Charr./Fr.  
**F2-127** 5 1/3 mm Ø 16 Charr./Fr.  
**F2-128** 6 mm Ø 18 Charr./Fr.



**PROBE, Double Ended**  
2.0 mm Ø

<b>F2-129</b>	11.5 cm 4 1/2"
<b>F2-130</b>	13.0 cm 5"
<b>F2-131</b>	14.5 cm 5 3/4"
<b>F2-132</b>	16.0 cm 6 1/4"
<b>F2-133</b>	18.0 cm 7"
<b>F2-134</b>	20.0 cm 8"
<b>F2-135</b>	25.0 cm 9 3/4"

**PROBE, Double Ended**  
1.5 mm Ø

<b>F2-136</b>	11.5 cm 4 1/2"
<b>F2-137</b>	13.0 cm 5"
<b>F2-138</b>	14.5 cm 5 3/4"
<b>F2-139</b>	16.0 cm 6 1/4"
<b>F2-140</b>	18.0 cm 7"
<b>F2-141</b>	20.0 cm 8"
<b>F2-142</b>	25.0 cm 9 3/4"

**PROBE, Double Ended**  
1.0 mm Ø

<b>F2-143</b>	11.5 cm 4 1/2"
<b>F2-144</b>	13.0 cm 5"
<b>F2-145</b>	14.5 cm 5 3/4"
<b>F2-146</b>	16.0 cm 6 1/4"
<b>F2-147</b>	18.0 cm 7"
<b>F2-148</b>	20.0 cm 8"
<b>F2-149</b>	25.0 cm 9 3/4"



**PROBE With Eye**  
2.0 mm Ø

<b>F2-150</b>	11.5 cm 4 1/2"
<b>F2-151</b>	13.0 cm 5"
<b>F2-152</b>	14.5 cm 5 3/4"
<b>F2-153</b>	16.0 cm 6 1/4"
<b>F2-154</b>	18.0 cm 7"
<b>F2-155</b>	20.0 cm 8"
<b>F2-156</b>	25.0 cm 9 3/4"

with eyelet



**PROBE**  
2.0 mm Ø

<b>F2-157</b>	11.5 cm 4 1/2"
<b>F2-158</b>	13.0 cm 5"
<b>F2-159</b>	14.5 cm 5 3/4"
<b>F2-160</b>	16.0 cm 6 1/4"

myrtle-shaped



**BUTTERFLY GROOVED**  
Director With Tongue Tie  
Plain End

<b>F2-161</b>	11.5 cm 4 1/2"
<b>F2-162</b>	13.0 cm 5"
<b>F2-163</b>	14.5 cm 5 3/4"
<b>F2-164</b>	16.0 cm 6 1/4"
<b>F2-165</b>	18.0 cm 7"
<b>F2-166</b>	20.0 cm 8"



**BUTTERFLY GROOVED**  
Director With Tongue Tie  
Plain End

<b>F2-167</b>	11.5 cm 4 1/2"
<b>F2-168</b>	13.0 cm 5"
<b>F2-169</b>	14.5 cm 5 3/4"
<b>F2-170</b>	16.0 cm 6 1/4"
<b>F2-171</b>	18.0 cm 7"
<b>F2-172</b>	20.0 cm 8"



**DOYEN**  
Probes & Directors  
**F2-173**  
14.0 cm 5 1/2"



**NÉLATON**  
Probes & Directors  
**F2-174**  
16.0 cm 6 1/4"



**JOPSON-HORNE**  
cotton applicator  
F2-175  
18.0 cm 7"



**FEIN**  
cotton applicator  
F2-176  
28.0 cm 11"



**FELTESON**  
cotton applicator  
F2-177  
23.0 cm 9"



**DARR Fistula Probe**  
F2-170  
with 0" (20.3 cm) sterling shaft,  
eye at tip 11-1/2" (29.2 cm) overall



**DARR Crypt Hook,**  
F2-179  
10" (25.4 cm), short and  
org hook ends



**BUIE Suction Tube,**  
F2-100  
10" (45 cm), with finger  
valve, 15 Fr. (5 mm)





**SCALPEL HANDLE, SCALPEL BLADES,  
DISSECTING KNIVES & SAWS**





## SCALPEL HANDLES

Skalpgriffe  
Mangcs de bisturies

Manches pour bisturis  
Manici per bisturi



Locks At 90°, 60°, 30°,  
Straight, 120°, 150°, 180°,  
Angles



**SCALPEL HANDLE #3**  
F3-001  
12.75 cm, 5"  
Blade Size 10, 11,  
12, 13, 15, 17



**#3 SCALPEL HANDLE/  
GRADUATED**  
F3-002  
12.75 cm, 5"  
Blade Size 10, 11,  
12, 13, 15, 17



**SCALPEL HANDLE #4  
GRADUATED**  
F3-003  
with scale



**SCALPEL HANDLE #4**  
F3-004  
12.75 cm, 5" Blade  
Size 18, 20, 21, 22,  
23, 24, 25, 6C, 70



**SCALPEL HANDLE 4LA**  
F3-005  
21 cm, 3 1/4" Blade  
Size 18, 20, 21, 22,  
23, 24, 25, 6C, 70



**SIEGEL ROUND  
SCALPEL HANDLE  
#3**  
F3-036  
With Adjustable  
Tip 16 cm, 6 1/4"  
Blade Size 10,  
11, 12, 13, 15,  
17

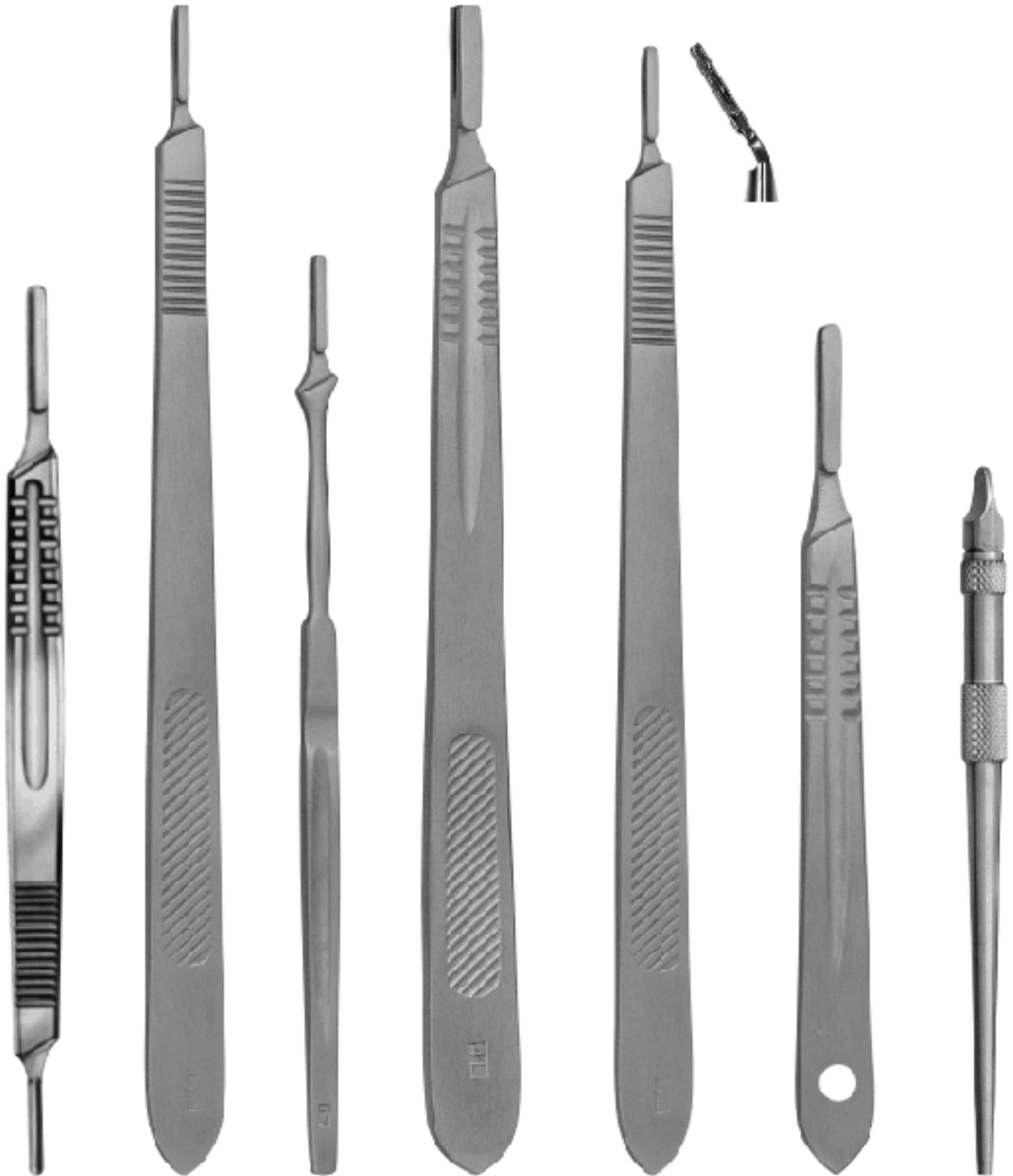

**SCALPEL HANDLE #3, #4**  
**F3-007**  
 Double Ended  
 16 cm, 6"

**SCALPEL HANDLE #3L LONG**  
**F3-008** 21 cm 8 1/2"  
 Blade Size  
 10, 11, 12, 15, 17

**SCALPEL HANDLE #7**  
**F3-009**  
 16.5 cm 6 1/2"  
 Blade 10, 11,  
 12, 13, 15, 17

**SCALPEL HANDLE #4L LONG**  
**F3-010** 21 cm, 8 1/2"  
 Blade  
 Size 18, 20, 21,  
 22, 23, 24, 25,  
 30, 70

**SCALPEL HANDLE #1 LONG ANGLE #31A**  
**F3-011**  
 20.25 cm, 8 1/4"  
 Blade Size  
 10, 11, 12, 15, 17

**KNIFE HANDLE F3-012**  
 (Smooth) for  
 Blades Nos.  
 60 and 70

**ROUND KNIFE HANDLE F3-013**  
 12.7 cm, 5"  
 Blade Size  
 50, 60 & 70



## SCALPEL HANDLES

Skalpgriffe  
Mangos de bisturíes

Manches pour bisturis  
Manici per bisturi



ROUND KNURLED  
SCALPEL HANDLE  
F3-014

12 cm, 4 3/8"



K&F ROUND  
SCALPEL HANDLE  
#3RK  
F3-015

15 cm, 5 3/4", Blade  
Size 10, 11,  
12, 13, 16, 17



CORWIN ROUND  
SCALPEL HANDLE  
#3R  
F3-016

14.5 cm, 5 1/2"  
Blade Size 10,  
11, 12, 16, 17



SCALPEL HANDLE  
#3RC  
F3-017

14 cm, 5 1/4"  
Blade Size 10,  
11, 12, 13, 16,  
17



CORWIN ROUND  
SCALPEL HANDLE  
#3R  
F3-018

14.5 cm, 5 1/2",  
Blade Size 18, 20,  
21, 22, 23, 24,  
26, 60, 70



SCALPEL HANDLE  
#3P  
F3-019

15.5 cm,  
6", Blade Size  
10, 11, 12, 13,  
16, 17



## SCALPEL BLADES

Skalpellsklingsen,

Hoias de bisturi, Manchas

Lames de bistouris, Mangos

Lame per bisturi, Manici



**F3-020**  
Sterile Scalpel  
Blade Size # 8  
Stainless Steel



**F3-021**  
Sterile Scalpel  
Blade Size # 10  
Stainless Steel



**F3-022**  
Sterile Scalpel  
Blade Size # 10A  
Stainless Steel



**F3-023**  
Sterile Scalpel  
Blade Size # 11  
Stainless Steel



**F3-024**  
Sterile Scalpel  
Blade Size # 11P  
Stainless Steel



**F3-025**  
Sterile Scalpel  
Blade Size # E11  
Stainless Steel



**F3-026**  
Sterile Scalpel  
Blade Size # 12  
Stainless Steel



**F3-027**  
Sterile Scalpel  
Blade Size # 13  
Stainless Steel



**F3-028**  
Sterile Scalpel  
Blade Size # 15  
Stainless Steel



**F3-029**  
Sterile Scalpel  
Blade Size # 15A  
Stainless Steel



**F3-030**  
Sterile Scalpel  
Blade Size # 17  
Stainless Steel



**F3-031**  
Sterile Scalpel  
Blade Size # 18  
Stainless Steel



**F3-032**  
Sterile Scalpel  
Blade Size # 20  
Stainless Steel



**F3-033**  
Sterile Scalpel  
Blade Size # 21  
Stainless Steel



**F3-034**  
Sterile Scalpel  
Blade Size # 22  
Stainless Steel



**F3-035**  
Sterile Scalpel  
Blade Size # 23  
Stainless Steel



**F3-036**  
Sterile Scalpel  
Blade Size # 24  
Stainless Steel



**F3-037**  
Sterile Scalpel  
Blade Size # 25  
Stainless Steel



**F3-038**  
Sterile Scalpel  
Blade Size # 36  
Stainless Steel



**F3-039**  
Sterile Scalpel  
Blade Size # 40  
Stainless Steel



**F3-040**  
Sterile Scalpel  
Blade Size # 60  
Stainless Steel



**F3-041**  
Sterile Scalpel  
Blade Size # 70  
Stainless Steel

**F3-042**  
 Fig. 1  
 16 cm, 6 1/4"

**F3-043**  
 Fig. 2  
 16 cm, 6 1/4"

**F3-044**  
 Fig. 3  
 16 cm, 6 1/4"

**F3-045**  
 Fig. 4  
 16 cm, 6 1/4"

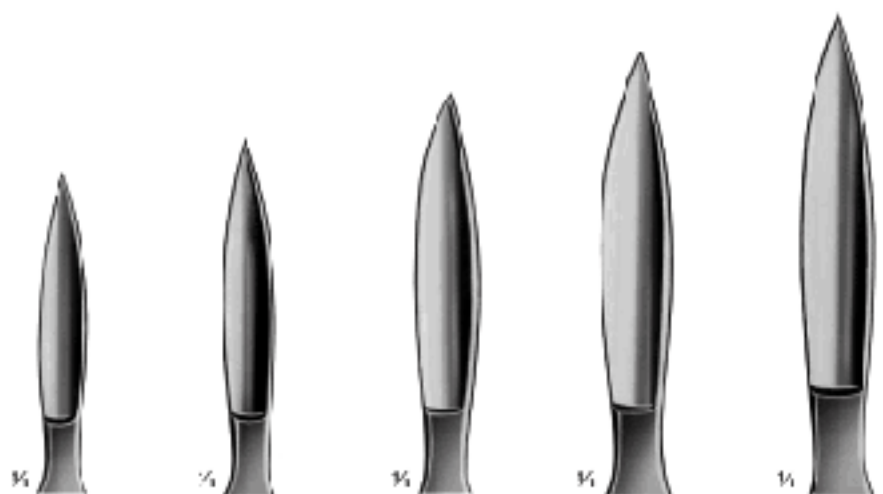
**F3-046**  
 Fig. 5  
 15 cm 6 1/4"

**F3-047**  
 Fig. 6  
 13 cm 6 1/4"

**F3-048**  
 Fig. 7  
 16 cm, 6 1/4"

**F3-049**  
 Fig. 8  
 16 cm, 6 1/4"

**F3-050**  
 Fig. 9  
 16 cm, 6 1/4"

**F3-051**  
 Fig. 10  
 16 cm, 6 1/4"

**DIEFFENBACH**  
 16 cm, 6 1/4"

**F3-052**  
 Fig. 15  
 16 cm, 6 1/4"

**F3-053**  
 Fig. 16  
 16 cm, 6 1/4"



**COLLIN DISSECTING KNIVES** Blade Size  
**F3-054** 13 cm, 5"  
**F3-055** 16 cm, 6 1/4"  
**F3-056** 19 cm, 7 1/2"  
**F3-057** 22 cm, 8 1/2"  
**F3-058** 28 cm, 11 1/4"



**CATLIN DISSECTING KNIVES** Blade Size  
**F3-059** 16 cm, 6 1/4"  
**F3-060** 19 cm, 7 1/2"  
**F3-061** 22 cm, 8 1/2"



**LISTON DISSECTING KNIVES** Blade Size  
**F3-062** 16 cm, 6 1/4"  
**F3-063** 19 cm, 7 1/2"  
**F3-064** 22 cm, 8 1/2"



**LANGENBECK DISSECTING KNIVES BLADE**  
**F3-065**  
 12 cm, 4 3/4"



**DIEFFENBACH DISSECTING KNIVES**  
**F3-066**  
 13 cm, 5"



**DIEFFENBACH DISSECTING KNIVES**  
**F3-067**  
 13 cm, 5"



**SIMON DISSECTING KNIVES**  
**F3-067**  
 23.5 cm, 9 1/2"



**F3-058**  
 Fig.1



**F3-060**  
 Fig. 2



**F3-073**  
 Fig. 3



**F3-071**  
 Fig. 4

*Amputationsmesser, Cuchillos para amputación  
Couteaux à amputation, coltelli per amputazione*

*Resektionsmesser, Cuchillos para resección  
Couteaux à résection, Coltelli per resezione*



**AMPUTATION  
KNIFE  
F3-372**  
29 cm, 11 3/8"



**AMPUTATION  
KNIFE  
F3-073**  
37.5 cm, 13"



**CATLIN  
AMPUTATION  
F3-074**  
29 cm, 11 3/8"



**RESECTION  
KNIFE  
F3-075**  
18 cm, 7"



**LANGENBECK  
AMPUTATION  
F3-076**  
18 cm, 7"



**LANGENBECK  
AMPUTATION  
F3-077**  
15 cm, 7"



**RAZOR HOLLOW  
Blades On  
Both Sides  
Blade Flat / Hollow  
F3-078**

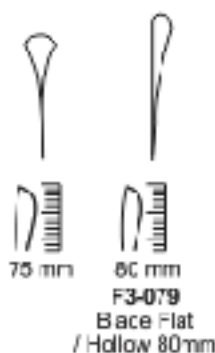

**CHARRIERE AMPUTATION  
& RESECTION  
F3-080 27 cm 11"  
F3-081 33 cm 12"**



**CHARRIERE AMPUTATION  
& RESECTION  
F3-082  
35 cm, 13 3/4"**



**SATTERLEE AMPUTATION  
& RESECTION  
F3-083  
31 cm, 12 1/4"**





F3-085  
spare blade

**HUMBY DERMATOMES**  
**F3-084** 31cm 12 1/4"  
 Complete with 1 Blade



**WATSON DERMATOMES**  
**F3-086** 30cm 12"  
 Complete with 1 Blade,  
 fixed bar



**SILVER DERMATOMES**  
**F3-087** 19cm 7 1/2"



## GENERAL OPERATING SCISSORS



**STANDARD OPERATING SCISSORS**
**Sharp/Sharp Straight**

F4-001	11.5 cm, 4 1/2"
F4-002	13.0 cm, 5"
F4-003	14.0 cm, 5 1/2"
F4-004	15.0 cm, 6"
F4-005	16.0 cm, 6 1/4"
F4-006	17.5 cm, 7"
F4-007	18.5 cm, 7 1/4"
F4-008	20.0 cm, 8"

 1/1 original  
4 1/2"

**STANDARD OPERATING SCISSORS**
**Sharp/Sharp Curved**

F4-009	11.5 cm, 4 1/2"
F4-010	13.0 cm, 5"
F4-011	14.0 cm, 5 1/2"
F4-012	15.0 cm, 6"
F4-013	16.0 cm, 6 1/4"
F4-014	17.5 cm, 7"
F4-015	18.5 cm, 7 1/4"
F4-016	20.0 cm, 8"

 1/1 original  
4 1/2"

**STANDARD OPERATING SCISSORS**
**Blunt/Blunt Straight**

F4-017	11.5 cm, 4 1/2"
F4-018	13.0 cm, 5"
F4-019	14.0 cm, 5 1/2"
F4-020	15.0 cm, 6"
F4-021	16.0 cm, 6 1/4"
F4-022	17.5 cm, 7"
F4-023	18.5 cm, 7 1/4"
F4-024	20.0 cm, 8"

 1/1 original  
4 1/2"

**STANDARD OPERATING SCISSORS**
**Blunt/Blunt Curved**

F4-025	11.5 cm, 4 1/2"
F4-026	13.0 cm, 5"
F4-027	14.0 cm, 5 1/2"
F4-028	15.0 cm, 6"
F4-029	16.0 cm, 6 1/4"
F4-030	17.5 cm, 7"
F4-031	18.5 cm, 7 1/4"
F4-032	20.0 cm, 8"

 1/1 original  
4 1/2"

**STANDARD OPERATING SCISSORS**
**Sharp/Blunt Straight**

F4-033	11.5 cm, 4 1/2"
F4-034	13.0 cm, 5"
F4-035	14.0 cm, 5 1/2"
F4-036	15.0 cm, 6"
F4-037	16.0 cm, 6 1/4"
F4-038	17.5 cm, 7"
F4-039	18.5 cm, 7 1/4"
F4-040	20.0 cm, 8"

 1/1 original  
4 1/2"

**STANDARD OPERATING SCISSORS**
**Sharp/Blunt Curved**

F4-041	11.5 cm, 4 1/2"
F4-042	13.0 cm, 5"
F4-043	14.0 cm, 5 1/2"
F4-044	15.0 cm, 6"
F4-045	16.0 cm, 6 1/4"
F4-046	17.5 cm, 7"
F4-047	18.5 cm, 7 1/4"
F4-048	20.0 cm, 8"

 1/1 original  
4 1/2"



# OPERATING & DISSECTING SCISSORS

Bedienen & Präparierscheren

D'exploitation & Ciseaux de dissection

Funcionamiento y disección Tijercs

Forbici di funzionamento e di dissezione



**F4-049**  
12.5 cm, 5"  
B/B Str.

**LANDOLT OPERATING  
SCISSORS**



**F4-050**  
12.5 cm, 5"  
B/B Cvd.



**DEAVER OPERATING,  
DISSECTING SCISSORS**



**F4-051**  
14.5 cm, 5 3/4"  
S/B Str.



**F4-052**  
14.5 cm, 5 3/4"  
S/S Cvd.



**F4-053**  
14.5 cm, 5 1/2"  
S/B Str.  
Saw Edge.



**F4-054**  
14.5 cm, 5 3/4"  
S/S Cvd.  
Saw Edge.



**F4-055**  
14.5 cm, 5 3/4"  
S/B Str.

**LONGE OPERATING,  
DISSECTING SCISSORS**



**F4-056**  
14.5 cm, 5 3/4"  
S/B Cvd.



**F4-057**  
14.5 cm, 5 3/4"  
S/B Str.  
Saw Edge.



**F4-058**  
14.5 cm, 5 1/4"  
S/S Cvd.  
Saw Edge.

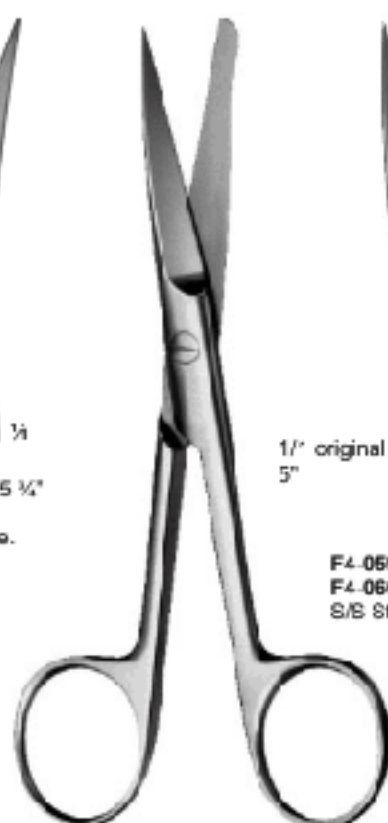

**INCISION OPERATING SCISSORS**



1/2" original  
5"

**F4-060** 13.0 cm, 5"  
**F4-060** 14.5 cm, 6 3/4"  
S/S Str.

**MAYO DISSECTING &  
GYNECOLOGICAL  
SCISSORS**

 1:1 original  
 5 3/4"

3/4

**F4-061**  
 14.5 cm 5 3/4"  
**F4-062**  
 15.0 cm 6"  
**F4-063**  
 17.0 cm 6 3/4"  
**F4-064**  
 19.5 cm 7 3/4"  
**F4-065**  
 21.0 cm 8 1/4"  
**F4-066**  
 23.0 cm 9"  
 B/B, Str

3/4

**F4-067**  
 14.5 cm 5 3/4"  
**F4-068**  
 15.0 cm 6"  
**F4-069**  
 17.0 cm 6 3/4"  
**F4-070**  
 19.5 cm 7 3/4"  
**F4-071**  
 21.0 cm 8 1/4"  
**F4-072**  
 23.0 cm 9"  
 B/B, Cvd

**MAYO-STILLIE DISSECTING &  
GYNECOLOGICAL SCISSORS**

 1:1 original  
 6"

3/4

**F4-073**  
 15.0 cm 6"  
**F4-074**  
 17.0 cm 6 3/4"  
**F4-075**  
 19.5 cm 7 3/4"  
**F4-076**  
 21.0 cm 8 1/4"  
 B/E, Str

3/4

**F4-077**  
 15.0 cm 6"  
**F4-078**  
 17.0 cm 6 3/4"  
**F4-079**  
 19.5 cm 7 3/4"  
**F4-080**  
 21.0 cm 8 1/4"  
 B/B, Cvd

**MAYO-HARRINGTON DISSECTING  
& GYNECOLOGICAL SCISSORS**

3/4

**F4-081**  
 22.5 cm 9"  
 B/B, Str

3/4

**F4-082**  
 22.5 cm 9"  
 B/B, Cvd

**MAYO-NOBLE DISSECTING  
& GYNECOLOGICAL SCISSORS**

3/4

**F4-083**  
 17.0 cm 6 3/4"  
 R/R, Cvd

3/4

**F4-084**  
 17.0 cm 6 3/4"  
 R/R, Str



**METZENBAUM OPERATING,  
DISSECTING SCISSORS  
BLUNT/BLUNT STR.**



**F4-085**  
14.5 cm 5 3/4"  
B/B Str.



**F4-086**  
18 cm 7"  
B/B Str.



**F4-087**  
20 cm 8"  
B/B Str.



**F4-088**  
23 cm 9"  
B/B Str.



**F4-089**  
25 cm 10"  
B/B Str.



**F4-090**  
28 cm 11"  
B/B Str.



**METZENBAUM OPERATING,  
DISSECTING SCISSORS  
BLUNT/BLUNT CVD.**



**F4-091**  
14.5 cm 5 3/4"  
B/B Cvd.



**F4-092**  
18 cm 7"  
B/B Cvd.



**F4-093**  
20 cm 8"  
B/B Cvd.



**F4-094**  
23 cm 9"  
B/B Cvd.



**F4-095**  
25 cm 10"  
B/B Cvd.



**F4-096**  
28 cm 11"  
B/B Cvd.

**METZENBAUM NELSON  
SCISSORS**

 1/1 original  
7"

- F4-097 18.0 cm 7"
- F4-098 20.0 cm 8"
- F4-099 23.0 cm 9"
- F4-100 25.0 cm 9 3/4"
- F4-101 28.0 cm 11"
- F4-102 30.0 cm 12"  
B/B Str.

 1/1 original  
7"

- F4-103 18.0 cm 7"
- F4-104 20.0 cm 8"
- F4-105 23.0 cm 9"
- F4-106 25.0 cm 9 3/4"
- F4-107 28.0 cm 11"
- F4-108 30.0 cm 12"  
S/B Str.



- F4-109 18.0 cm 7"
- F4-110 20.0 cm 8"
- F4-111 23.0 cm 9"
- F4-112 25.0 cm 9 3/4"
- F4-113 28.0 cm 11"
- F4-114 30.0 cm 12"  
S/S Str.

**METZENBAUM-NELSON  
SCISSORS**

 1/1 original  
7"

- F4-115 18.0 cm 7"
- F4-116 20.0 cm 8"
- F4-117 23.0 cm 9"
- F4-118 25.0 cm 9 3/4"
- F4-119 28.0 cm 11"
- F4-120 30.0 cm 12"  
B/B Cvd.

 1/1 original  
7"

- F4-121 18.0 cm 7"
- F4-122 20.0 cm 8"
- F4-123 23.0 cm 9"
- F4-124 25.0 cm 9 3/4"
- F4-125 28.0 cm 11"
- F4-126 30.0 cm 12"  
S/B Cvd.



- F4-127 18.0 cm 7"
- F4-128 20.0 cm 8"
- F4-129 23.0 cm 9"
- F4-130 25.0 cm 9 3/4"
- F4-131 28.0 cm 11"
- F4-132 30.0 cm 12"  
S/S Cvd.

**METZENBAUM FINO  
SCISSORS**

 $\frac{1}{4}$ 
**F4-133**  
14.5 cm 5 3/4"  
B/B Str.

 $\frac{1}{4}$ 
**F4-134**  
14.5 cm 5 3/4"  
S/S Str.

 $\frac{1}{4}$ 
**F4-135**  
14.5 cm 5 3/4"  
B/B Cvd.

 $\frac{1}{4}$ 
**F4-136**  
14.5 cm 5 3/4"  
S/S Cvd.

**METZENBAUM-FINO  
SCISSORS**

 $\frac{1}{4}$ 
**F4-137**  
18 cm 7"  
**F4-138**  
220 cm 8"  
**F4-139**  
230 cm 9"  
R/R Str

*1/1 original*  
/

 $\frac{1}{4}$ 
**F4-140**  
18 cm 7"  
**F4-141**  
220 cm 8"  
**F4-142**  
230 cm 9"  
R/R Cvd

*1/1 original*  
/

 $\frac{1}{4}$ 
**F4-143**  
18 cm 7"  
**F4-144**  
220 cm 8"  
**F4-145**  
230 cm 9"  
R/R Slightly  
Cvd





**RICHTER OPERATING,  
DISSECTING SCISSORS**  
F4-146 14.5 cm, 5 3/4"  
Angled



**JOSEPH OPERATING,  
DISSECTING SCISSORS**

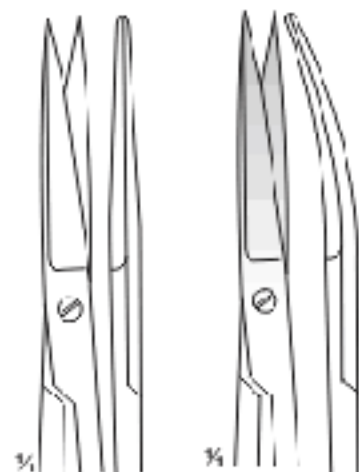

**F4-147**  
14.0 cm, 5 1/2"  
S/S Str.

**F4-143**  
14.0 cm, 5 1/2"  
S/S Cvd.



**KELLY OPERATING,  
DISSECTING SCISSORS**

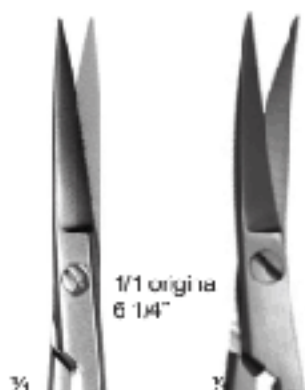

**F4-149**  
16.0 cm, 6 1/4"  
**F4-150**  
18.0 cm, 7"  
S/S Str.

**F4-151**  
15.0 cm, 6 1/4"  
**F4-152**  
13.0 cm, 7"  
S/S Cvd.



**DOYEN OPERATING,  
DISSECTING SCISSORS**  
F4-153 17.5 cm, 7"  
B/B, Str.



**DOYEN OPERATING,  
DISSECTING SCISSORS**  
F4-154 17.5 cm, 7"  
B/B, Cvd.

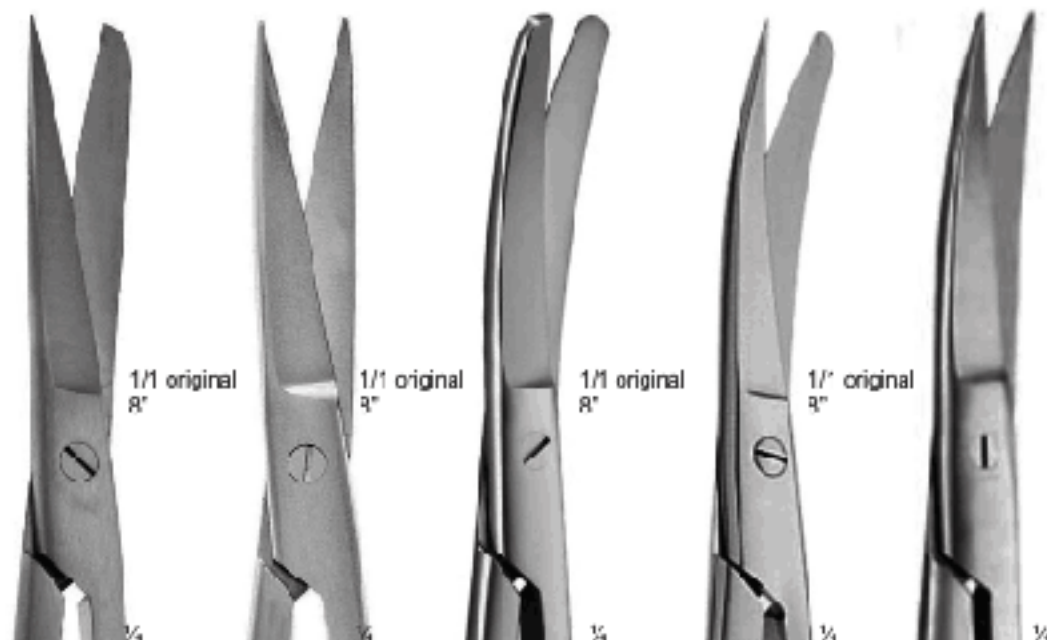

<b>F4-157</b> 20.0 cm, 8"	<b>F4-158</b> 20.0 cm, 8"	<b>F4-159</b> 20.0 cm, 8"	<b>F4-161</b> 20.0 cm, 8"	<b>F4-163</b> 20.0 cm, 8"	<b>F4-155</b> 20.0 cm, 8"
<b>F4-156</b> 23.0 cm, 9"	<b>F4-160</b> 23.0 cm, 9"	<b>F4-162</b> 23.0 cm, 9"	<b>F4-164</b> 23.0 cm, 9"	<b>F4-166</b> 23.0 cm, 9"	<b>F4-165</b> 23.0 cm, 9"
Str, S/B	Str, S/S	Cvd, B/S	Cvc, S/B	Cvd, S/S	Cvd, S/S

**SIMS DISSECTING & GYNECOLOGICAL SCISSORS**

**F4-155** 20.0 cm, 8"  
**F4-156** 23.0 cm, 9"  
 Str. E/B



<b>F4-167</b> 00 cm, 3 1/2"	<b>F4-171</b> 00 cm, 3 1/2"	<b>F4-175</b> 11.5 cm, 4 1/2"	<b>F4-176</b> 11.5 cm, 4 1/2"	<b>F4-177</b> 11.5 cm, 4 1/2"
<b>F4-168</b> 10.5 cm, 4 1/2"	<b>F4-172</b> 10.5 cm, 4 1/2"	Angular Left	Laterally Cvd	Angular Right
<b>F4-169</b> 11.5 cm, 4 1/2"	<b>F4-173</b> 11.5 cm, 4 1/2"			
<b>F4-170</b> 12.0 cm, 4 3/4"	<b>F4-174</b> 12.0 cm, 4 3/4"			
S/S Str.	S/S Cvd.			

**Iris Scissors**



**VASCULAR SCISSORS**  
**F4-178** 19.0 cm, 7 1/2"  
 S/S Angled 125°



**COCLEY REVERSE CUT SCISSORS**  
**F4-179** 17.1 cm, 6 3/4"  
 S/S angled 125°



**POTTS-SMITH VASCULAR SCISSORS**  
 S/S Angled



**F4-180**  
 19.0 cm, 7 1/2"  
 25°



**F4-181**  
 19.0 cm, 7 1/2"  
 45°

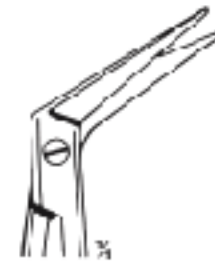

**F4-182**  
 19.0 cm, 7 1/2"  
 60°



**F4-183**  
 19.0 cm, 7 1/2"  
 125°



**HEGEMANN DIETH-RICH VASCULAR SCISSORS**  
 S/S Angled



**F4-184** 16.0 cm, 6 1/4"  
**F4-185** 10.0 cm, 7 1/2"



**F4-185** 13.0 cm, 6 1/2"  
**F4-187** 13.0 cm, 7 1/2"



**F4-186** 16.0 cm, 6 1/4"  
**F4-188** 10.0 cm, 7 1/2"

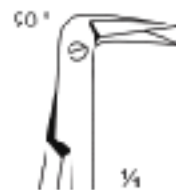

**F4-190** 15.0 cm, 6 1/4"  
**F4-191** 19.0 cm, 7 1/2"



**F4-192** 16.0 cm, 6 1/4"  
**F4-193** 19.0 cm, 7 1/2"

 1/1 original  
 6 1/2"

- 25°  
**F4-194** 16.0 cm, 6 1/2"  
**F4-195** 19.0 cm, 7 1/2"  
**F4-196** 23.0 cm, 9"  
**F4-197** 28.0 cm, 11"

 1/1 original  
 6 1/2"

- 45°  
**F4-198** 16.0 cm, 6 1/2"  
**F4-199** 19.0 cm, 7 1/2"  
**F4-200** 23.0 cm, 9"  
**F4-201** 28.0 cm, 11"

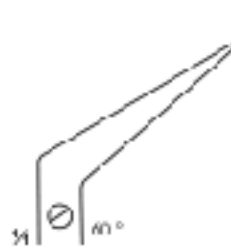

- 60°  
**F4-202** 16.0 cm, 6 1/2"  
**F4-203** 19.0 cm, 7 1/2"  
**F4-204** 23.0 cm, 9"  
**F4-205** 28.0 cm, 11"

**DE BAKEY VASCULAR SCISSORS**  
 S/S Angled

**COOLEY VASCULAR SCISSORS**  
**F4-206** 18.4 cm, 7 1/2" 1 mm  
**F4-207** 18.4 cm, 7 1/2" 1.6 mm  
 probe point on tip.  
 S/S Angled 46°

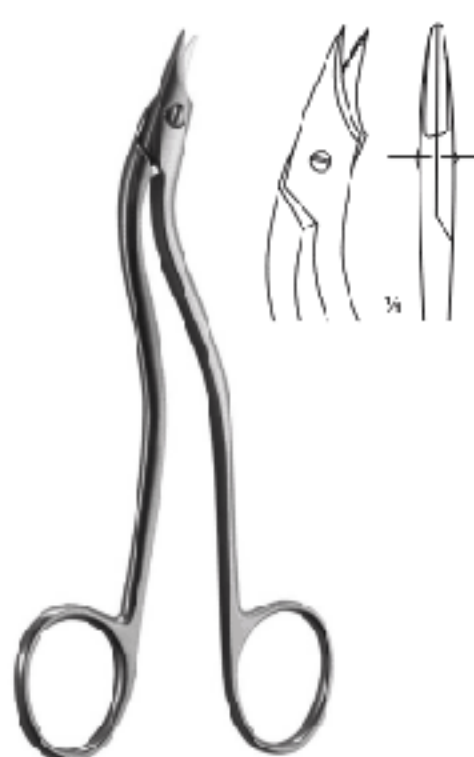
**D'BRIEN VASCULAR SCISSORS**  
**F4-208** 9.0 cm, 3 1/2"  
 S/S Angled

**HEATH VASCULAR SCISSORS**  
**F4-209** 15.0 cm, 6"  
 S/S Double Cvd.

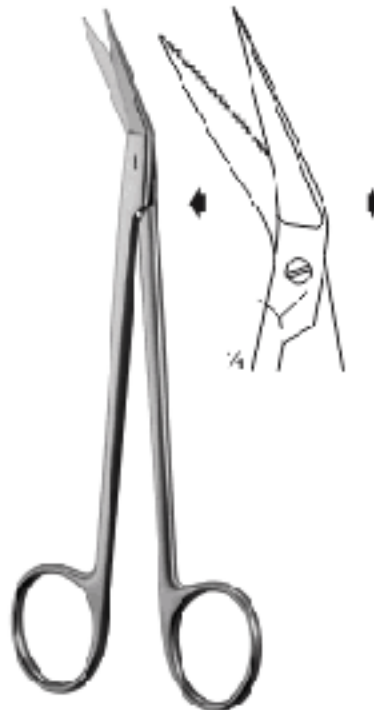

**F4-210**  
17.0 cm, 6 3/4"  
Serrated Blade S/S  
Double Conv.

**DEAN DELICATE  
DISSECTING SCISSORS**



**Locklin Dissecting Scissors**  
**F4-211** 16.5 cm, 6 1/2"  
S/S

**F4-211** 16.5 cm, 6 1/2"  
S/S



**FAVALORD CORONARY**  
**F4-212** 10.5 cm, 4"  
S/S Angled 90°

**F4-212** 10.5 cm, 4"  
S/S Angled 90°



**ENT-DEAN SCISSORS**  
**F4-213** 17 cm, 6 3/4"  
S/S Double Conv.  
Serrated

**F4-213** 17 cm, 6 3/4"  
S/S Double Conv.  
Serrated



**DE BAKKEY VASCULAR  
SCISSORS**

**F4-214** 15.5 cm, 6"  
S/S



**F4-214**  
15.5 cm, 6"  
S/S



**F4-216**  
15.5 cm, 6"  
S/S

**F4-216**  
15.5 cm, 6"  
S/S

**STEVENS SCISSORS**

 $\frac{1}{4}$ 

**F4-216**  
10 cm 4"  
**F4-217**  
11.5 cm 4 1/2"  
S/S Str.

 $\frac{1}{4}$ 

**F4-218**  
10 cm 4"  
**F4-219**  
11.5 cm 4 1/2"  
S/S Cvd.

**STEVENS SCISSORS**

 $\frac{1}{4}$ 

**F4-220**  
10 cm 4"  
**F4-221**  
11.5 cm 4 1/2"  
3/B Str.

 $\frac{1}{4}$ 

**F4-222**  
10 cm 4"  
**F4-223**  
11.5 cm 4 1/2"  
B/B Cvd.



**NAIL SCISSORS**  
**F4-224** 9 cm, 3 1/2"  
S/S, Cvd.

 $\frac{1}{4}$ 

**NAIL SCISSORS**  
**F4-225** 9 cm, 3 1/2"  
S/S, Cvd.

 $\frac{1}{4}$ 

**NAIL SCISSORS**  
**F4-226** 9 cm 3 1/2"  
Arrow Point Curved

 $\frac{1}{4}$



**STITCHES SCISSORS**  
**F4-227** 12.0 cm, 4 3/4"  
 Str.

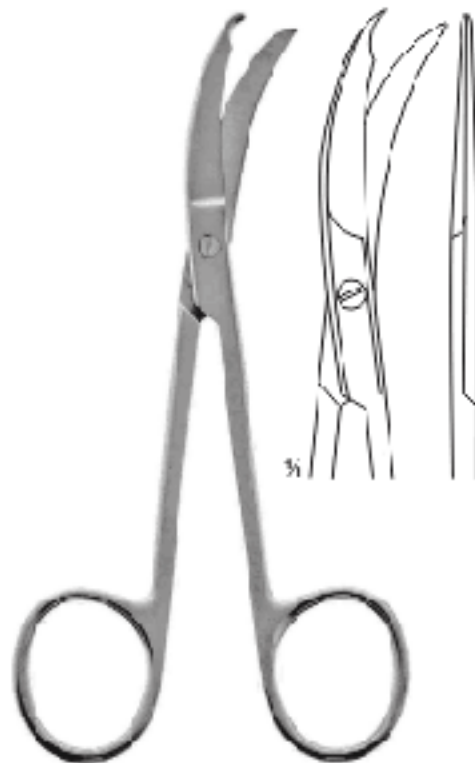

**NORTHBENT STITCHES SCISSORS**  
**F4-228** 12.5 cm 5"  
 Cvd.

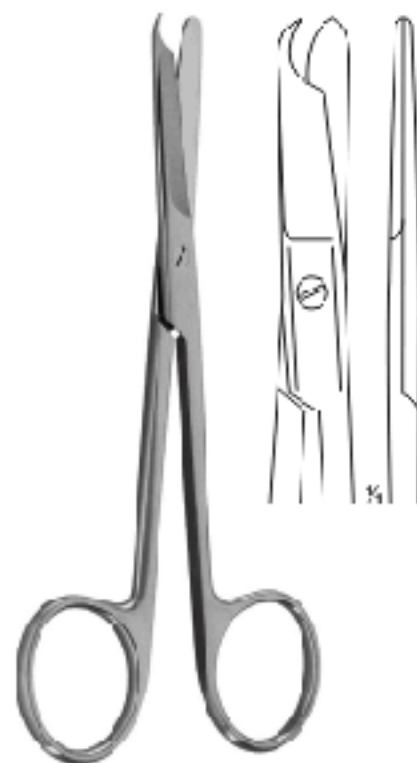

**LITTAUER STITCH SCISSORS**  
**F4-229** 14 cm, 5 1/2"  
 Str.



**BUCK STITCH SCISSORS**



**F4-231**  
 18.0 cm, 7"  
 Str.

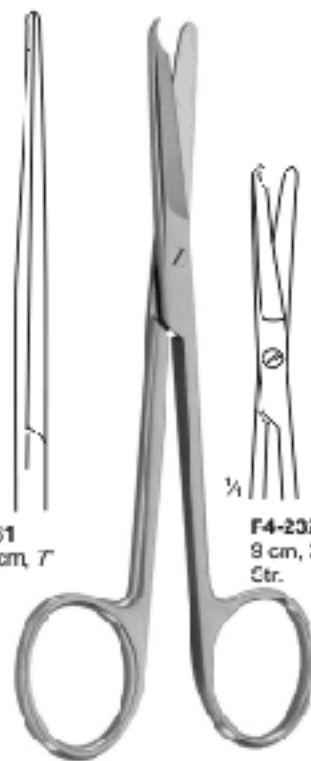

**SPENCER STITCH SCISSORS**



**F4-232**  
 9 cm, 3 1/2"  
 Ctr.



**F4-233**  
 11.5 cm, 4 1/2"  
 Ctr.



**SHORTBENT STITCH SCISSORS**  
**F4-234** 9 cm, 3 1/2"  
 Cvd.

Tonsillensteiner Schere, Nasenschere  
 Tijeras de amígdalas, tijeras nasales

Ciseaux d'amygdales, Ciseaux nasaux  
 Tonsille forbici, forbici nasali



**COTTLE SCISSORS**  
 F4-235 16 cm 6 1/2"  
 B/B, Angled



**FOMON SCISSORS**  
 F4-236 14.5 cm 5 1/2"  
 B/B, Angled



**SAILER SCISSORS**  
 F4-237 17.0 cm 6 3/4"  
 B/B, Angled



**HEYMANN SCISSORS**  
 F4-238 13 cm, 7"  
 F4-239 13.5 cm, 7 1/4"  
 B/B, Angled



**HEYMANN SCISSORS**  
 F4-240 13.0 cm, 7"  
 B/B, Angled



**OLIVECRONA VASCULAR SCISSORS**  
 F4-241 23.0 cm, 9"  
 B/B



*Chirurgische scheren, Gum Scheren*  
*Goma Tijeras y Tijeras de funcionamiento*

*Gum Ciseaux et Ciseaux d'exploitation*  
*Gum Forbici & Forbici Operativi*



**GOOD SCISSORS**  
**F4-242** 19.0 cm, 7 1/2"  
 Probe End, Cvd.



**PRINCE SCISSORS**  
**F4-243** 17.5 cm, 7"  
 B/B, Cvd.



**HALLE SCISSORS**  
**F4-244** 19.0 cm, 7 1/2"  
 3/B, Cvd.



**SULLIVAN SCISSORS**  
 One Teeth Is Serrated As Per



**F4-245**  
 14.5 cm, 5 3/4"  
 Pointed Tip  
 S/S, Str.



**F4-246**  
 14.5 cm, 5 3/4"  
 Pointed Tip  
 S/S, Cvd.

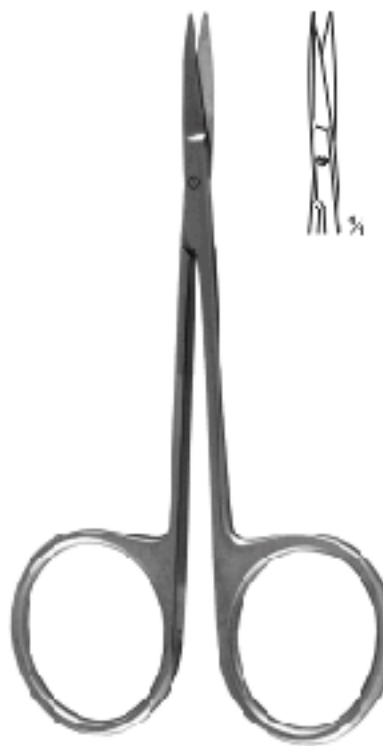

**MOD. DONN SCISSORS**  
**F4-247** 8.0 cm, 3"  
 S/S, Str.



**MOD. DONN SCISSORS**  
**F4-248** 8.0 cm, 3"  
 S/S, Cvd.



**F4-249**  
10.5 cm 4 1/4"  
**F4-250**  
12.0 cm 4 3/4"  
B/B Str.  
**F4-251**  
10.5 cm 4 1/4"  
**F4-262**  
12.0 cm 4 3/4"  
B/B Str.  
Saw Edge



**F4-253**  
10.5 cm 4 1/4"  
**F4-254**  
12.0 cm 4 3/4"  
S/S Str.  
**F4-255**  
10.5 cm 4 1/4"  
**F4-266**  
12.0 cm 4 3/4"  
S/S Str.  
Saw Edge



**F4-257**  
10.0 cm 4"  
**F4-258**  
12.0 cm 4 3/4"  
B/B Cvd.  
**F4-259**  
10.0 cm 4"  
**F4-260**  
12.0 cm 4 3/4"  
B/B Cvd.  
Saw Edge



**F4-261**  
10.0 cm 4"  
**F4-262**  
12.0 cm 4 3/4"  
S/S Cvd.  
**F4-263**  
10.0 cm 4"  
**F4-264**  
12.0 cm 4 3/4"  
S/S Cvd.  
Saw Edge

**BEEBEE WIRE CUTTING SCISSORS**
**BEEBEE WIRE CUTTING SCISSORS**

**SYSTRUNK**  
**F4-255**  
13.0 cm 5"  
S/S, Str.



**SYSTRUNK**  
**F4-265**  
13.0 cm 5"  
S/S, Cvd.

**SYSTRUNK SCISSORS**

**UNIVERSAL WIRE CUTTING SCISSORS**  
**F4-267** 12 cm, 4 3/4"



**NAIL NIPPERS**  
 F4-268 11 cm 4 1/4"  
 F4-269 13 cm 5"  
 F4-270 15 cm 6"



**NAIL NIPPERS**  
 F4-271 14 cm 5 1/2"



**NAIL NIPPERS**  
 F4-272 14 cm 5 1/2"



**TURNBULL NIPPERS**  
 F4-273 11.5 cm 4 1/2"  
 F4-274 13 cm 5"



**NAIL NIPPERS**  
 F4-275 10.5 cm 4 1/2"



**COHEN NIPPERS**  
 F4-276 10.5 cm 4 1/2"



**ARTERY SCISSORS**  
Probe end Angled



**F4-277**  
18.0 cm, 7"  
25°



**F4-278**  
18.0 cm, 7"  
45°

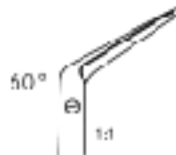

**F4-279**  
18.0 cm, 7"  
60°



**F4-280**  
18.0 cm, 7"  
90°



**F4-281**  
18.0 cm, 7"  
125°



**F4-282**  
18.0 cm, 7"  
25°



**F4-283**  
18.0 cm, 7"  
45°

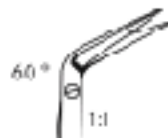

**F4-284**  
18.0 cm, 7"  
60°



**F4-285**  
18.0 cm, 7"  
90°



**F4-286**  
18.0 cm, 7"  
125°



**F4-287**  
 9.0 cm, 3 1/2"  
 S/D Str.



**F4-288**  
 9.0 cm, 3 1/2"  
 S/D Cvd.



**F4-289**  
 9.0 cm, 3 1/2"  
 S/S Str.



**F4-290**  
 9.0 cm, 3 1/2"  
 S/S Cvd.



**F4-291**  
 11.4 cm, 4 1/2"  
 B/B Str.



**F4-292**  
 11.4 cm, 4 1/2"  
 B/B Cvd.



**F4-293**  
 11.4 cm, 4 1/2"  
 S/B Str.



**F4-294**  
 11.4 cm, 4 1/2"  
 S/B Cvd.



**F4-295**  
 11.4 cm, 4 1/2"  
 S/S Str.



**F4-296**  
 11.4 cm, 4 1/2"  
 S/S Cvd.



**F4-297**  
 14 cm, 5 1/2"  
 B/B Str.



**F4-298**  
 14 cm, 5 1/2"  
 B/B Cvd.



**F4-299**  
 14 cm, 5 1/2"  
 S/B Str.



**F4-300**  
 14 cm, 5 1/2"  
 S/B Cvd.



**F4-301**  
 14 cm, 5 1/2"  
 S/S Str.



**F4-302**  
 14 cm, 5 1/2"  
 S/S Cvd.



**CASTROVIEJO SCISSORS**  
 Spring Type



**F4-303**  
12 cm, 4 3/8"  
S/S



**F4-304**  
12 cm, 4 3/8"  
S/R



**F4-305**  
12 cm, 4 1/2"  
B/B



**NOYES SCISSORS**  
Spring Handle  
**F4-306** 12 cm, 4 3/8"  
Angled,



**F4-307**  
11.0 cm, 4 1/4"  
S/B



**F4-308**  
11.0 cm, 4 1/4"  
B/B



**F4-309**  
11.0 cm, 4 1/4"  
S/S



**BARRAKER SCISSORS**  
**F4-310** Sharp Points  
**F4-311** Blunt Points  
5.5 cm, 2 1/4"



**CASTROVIEJO CORNEAL MICRO SCISSORS**  
**F4-312** 11 cm, 4 1/3"  
Left Angled,  
Spring Handle



**CASTROVIEJO CORNEAL MICRO SCISSORS**  
**F4-313** 11 cm, 4 1/3"  
Right Angled,  
Spring Handle



**TROUTMAN MICRO SCISSORS**  
**F4-314** 10.0 cm, 4"  
Left Angled,  
Spring Handle



**TROUTMAN MICRO SCISSORS**  
**F4-315** 10.0 cm, 4"  
Right Angled,  
Spring Handle



**WESTCOTT MICRO SCISSORS**



**F4-316**  
11.0 cm, 4 1/2"  
S/S Str.



**F4-318**  
11.0 cm, 4 1/2"  
S/S Cvd.

**F4-317**  
13.3 cm, 5 1/4"  
S/S Str.

**F4-319**  
13.3 cm, 5 1/4"  
S/S Cvd.

*Mikroschere* | *micro Cisnux*  
*Micro Tijeras* | *Micro Forbid*

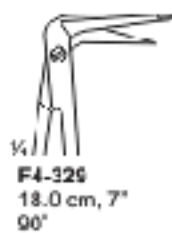

**MICRO SCISSORS**  
**F4-320** 12.0 cm, 4 1/4" S/S, Angled  
 S/S, Cvd.

**MICRO SCISSORS**  
 S/S, Angled pointed probe



**F4-332** 20 cm, 8"  
**F4-333** 22.5 cm, 9"  
 S/S, Str.



**F4-335** 20 cm, 8"  
**F4-336** 22 cm, 8 3/4"  
 S/S, Cvd.



**F4-338** 20 cm, 8"  
**F4-339** 22 cm, 8 3/4"  
 B/B, Str.



**F4-341** 20 cm, 8"  
**F4-342** 22 cm, 8 3/4"  
 S/S, Str.



**F4-344** 20 cm, 8"  
**F4-345** 22 cm, 8 3/4"  
 S/S, Cvd.



**F4-347** 20 cm, 8"  
**F4-348** 22 cm, 8 3/4"  
 B/B, Cvd.



**YASARGILL SCISSORS**

**NOYES MICRO SCISSORS**  
**F4-349** 15.0 cm, 6"  
 S/S

**NOYES MICRO SCISSORS**  
**F4-350** 14.5 cm, 5 3/4"  
 S/S

**UNIVERSAL PARAMEDIC SHEAR**

- F4-351 14 cm 5 3/4" (BLACK)
- F4-352 14 cm 5 3/4" (BLUE)
- F4-353 14 cm 5 3/4" (ROYAL BLUE)
- F4-354 14 cm 5 3/4" (BURGANDY)
- F4-355 14 cm 5 3/4" (GREEN)
- F4-356 14 cm 5 3/4" (MAGENTA)
- F4-357 14 cm 5 3/4" (CRANGE)
- F4-358 14 cm 5 3/4" (PINK)
- F4-359 14 cm 5 3/4" (PURPLE)
- F4-360 14 cm 5 3/4" (RED)
- F4-361 14 cm 5 3/4" (TEAL)
- F4-362 14 cm 5 3/4" (WHITE)
- F4-363 14 cm 5 3/4" (YELLOW)

- F4-364 16 cm 6 1/4" (BLACK)
- F4-365 16 cm 6 1/4" (BLUE)
- F4-366 14 cm 5.5" (ROYAL BLUE)
- F4-367 14 cm 5.5" (BURGANDY)
- F4-368 16 cm 6 1/4" (GREEN)
- F4-369 16 cm 6 1/4" (MAGENTA)
- F4-370 16 cm 6 1/4" (ORANGE)
- F4-371 16 cm 6 1/4" (PINK)
- F4-372 16 cm 6 1/4" (PURPLE)
- F4-373 16 cm 6 1/4" (RED)
- F4-374 16 cm 6 1/4" (TEAL)
- F4-375 16 cm 6 1/4" (WHITE)
- F4-376 16 cm 6 1/4" (YELLOW)

\*43 C/290 F Autoclavable





## UNIVERSAL SCISSORS

Universal-Schere | Cizoriu universel  
Tijeras universales | Forbici universali

UNIVERSAL  
PARAMEDIC SHEAR  
F4-377  
14 cm 5.5"  
(GREEN)



UNIVERSAL  
PARAMEDIC SHEAR  
F4-382  
14 cm 5.5"  
(PINK)



UNIVERSAL  
PARAMEDIC SHEAR  
F4-381  
14 cm 5.5"  
(BURGANDY)



UNIVERSAL  
PARAMEDIC SHEAR  
F4-370  
14 cm 5.5"  
(ROYAL BLUE)



UNIVERSAL  
PARAMEDIC SHEAR  
F4-376  
14 cm 5.5"  
(RED)



UNIVERSAL  
PARAMEDIC SHEAR  
F4-380  
14 cm 5.5"  
(BLACK)



## UNIVERSAL SCISSORS

Universal-Schere | Ciseaux universelles

Tijeras universales | Forbici universali

UNIVERSAL PARAMEDIC  
SHEAR PROB END  
F4-333  
14 cm 5.5"  
(YELLOW)



UNIVERSAL PARAMEDIC  
SHEAR PROB END  
F4-390  
14 cm 5.5"  
(ROYAL BLUE)



UNIVERSAL PARAMEDIC  
SHEAR PROB END  
F4-334  
14 cm 5.5"  
(Chartreuse)



UNIVERSAL PARAMEDIC  
SHEAR PROB END  
F4-388  
14 cm 5.5"  
(WHITE)



UNIVERSAL PARAMEDIC  
SHEAR PROB END  
F4-385  
14 cm 5.5"  
(RED)



UNIVERSAL PARAMEDIC  
SHEAR PROB END  
F4-386  
14 cm 5.5"  
(BLACK)



UNIVERSAL PARAMEDIC  
SHEAR PROB END  
F4-388  
14 cm 5.5"  
(GREEN)



UNIVERSAL PARAMEDIC  
SHEAR PROB END  
F4-387  
14 cm 5.5"  
(BURGUNDY)





## UNIVERSAL SCISSORS

Universal-Schere | Ciseaux universelles

Tijeras universales | Forbici universali

**UNIVERSAL  
PARAMEDIC SHEAR  
F4-391  
14 cm 5.5"  
(BLACK)**



**UNIVERSAL  
PARAMEDIC SHEAR  
F4-395  
14 cm 5.5"  
(BLUE)**



**UNIVERSAL  
PARAMEDIC SHEAR  
F4-392  
14 cm 5.5"  
(ORANGE)**



**UNIVERSAL  
PARAMEDIC SHEAR  
F4-396  
14 cm 5.5"  
(YELLOW)**



**UNIVERSAL  
PARAMEDIC SHEAR  
F4-393  
14 cm 5.5"  
(WHITE)**



**UNIVERSAL  
PARAMEDIC SHEAR  
F4-397  
14 cm 5.5"  
(BURGLINDY)**



**UNIVERSAL  
PARAMEDIC SHEAR  
F4-394  
14 cm 5.5"  
(ORANGE)**



**UNIVERSAL  
PARAMEDIC SHEAR  
F4-398  
14 cm 5.5"  
(DEEP YELLOW)**





## PLASTER SCISSORS

Gips Schere  
Tijeras Yeso

plâtre Ciseaux  
Intonaco Forbici



**ESMARCH KNIFE**  
F4-396 18 cm, 7"



**BRUNS SCISSORS**

**F4-400**  
24 cm, 9 1/2"  
Cvd, Probe End



**F4-401**  
24 cm, 9 1/2"  
Cvd, Serrated  
Probe End



**LISTER-EXCENTRIC  
PLASTER SCISSORS**  
F4-402 16 cm, 6 1/4"  
F4-403 19 cm, 7 1/2"  
Angled, Probe End



Edge Upper  
is Serrated



**LISTER BANDAGE PLASTER  
SCISSORS**, one large ring  
F4-404 9 cm, 3 1/2"  
F4-405 11 cm, 4 1/3"  
F4-406 14 cm, 5 1/2"  
F4-407 15 cm, 6"  
F4-408 18 cm, 7"  
F4-409 20 cm, 8"  
Angled, Probe End



**BERGMANN SCISSORS**  
F4-410 23 cm, 9"  
Angled, Probe End



**ESMARCH SCISSORS**  
F4-411 20 cm, 8"  
F4-412 23 cm, 9"  
Angled, Probe End



**LISTER BANDAGE  
PLASTER SCISSORS**  
F4-413 9 cm, 3 1/2"  
F4-414 11 cm, 4 1/3"  
F4-415 14 cm, 5 1/2"  
F4-416 15 cm, 6"  
F4-417 18 cm, 7"  
F4-418 23 cm, 8"  
Angled, Probe End



**PLASTER SCISSORS**  
F4-419 17 cm, 6 1/4"  
Angled



**BURNHAM BANDAGE  
PLASTER SCISSORS**  
F4-420 14 cm, 5 1/2"  
Angled



**DANDAGE SCISSORS**  
**F4-421**  
 16.0 cm 6 1/4"



**SMITHI (Mod. Use)  
 PLASTER SCISSORS**  
**F4-422** 16 cm, 6 1/4"  
**F4-423** 18 cm, 7"  
**F4-424** 20 cm, 8"  
**F4-425** 23 cm, 9"



**LORENZ PLASTER  
 SCISSORS**  
**F4-426** 23 cm, 9"  
 B/B, Cvd



**LANGE DANDAGE  
 SCISSORS**  
**F4-427** 10.0 cm 7"  
 D/D



**BRAUN-STADLER  
 PLASTER SCISSORS**  
**F4-428** 14 cm, 5 1/2"  
**F4-429** 22 cm, 8 3/4"  
 3/B, Angled



**BUSCH PLASTER  
 SCISSORS**  
**F4-430** 13 cm, 5"  
**F4-431** 16 cm, 6 1/4"  
 B/B, Cvd



**KNOWLES PLASTER  
 SCISSORS**  
**F4-432** 14 cm, 5 1/2"  
 Str. Probe End



**KNOWLES PLASTER  
 SCISSORS**  
**F4-433** 14 cm, 5 1/2"  
 Angled. Probe End



**WALDMANN PLASTER  
 SCISSORS**  
**F4-434** 18 cm, 7"  
 Probe End



**WALDMANN SCISSORS**  
**F4-435** 18 cm, 7"



**SCHUMACHER PLASTER SCISSORS**  
**F4-436** 16 cm, 6 1/4"



**MODIFIED-USA PLASTER SCISSORS**  
**F4-437** 13.5 cm, 4 1/4"



**MARBACH PLASTER SCISSORS**  
**F4-438** 15.5 cm, 5"  
 Probe End, Serrated blade



**SEUTIN PLASTER SCISSORS**  
**F4-439** 20.0 cm 8"  
 Probe End



**SEUTIN PLASTER SCISSORS**  
**F4-440** 23.0 cm 9"  
 Probe End



**STILLE PLASTER SHEARS**  
**F4-441** 23 cm, 9"  
**F4-442** Spare Blade



**STILLE PLASTER SHEARS**  
**F4-443** 26 cm, 10 1/2"  
**F4-444** Spare Blade



**STILLE PLASTER SHEARS**  
**F4-445** 37 cm, 14 1/2"  
**F4-446** Spare Blade



**STILLE PLASTER SHEARS**  
**F4-447** 24 cm, 9 1/2"  
**F4-443** Spare Blade

GipsScheren  
Tijeras Yeso

plătres Cisecut  
Cesote in gesso



**HENNING PLASTER CAST SPREADER**  
F4-449 28 cm, 11"



**MODEL USA CAST SPREADER PLASTER**  
F4-450 23 cm, 9" 3 Prong

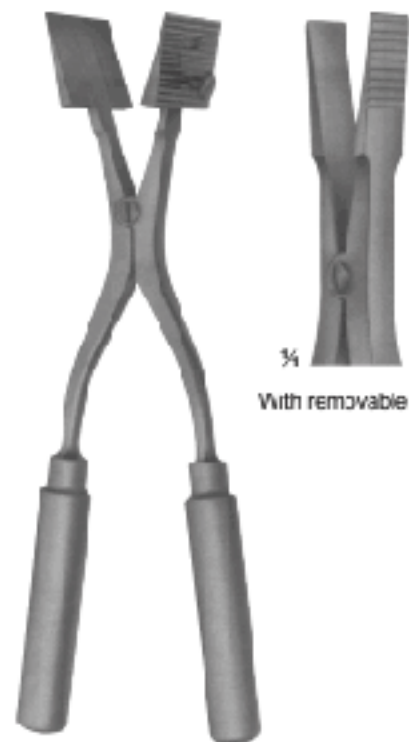

**SPREADER PLASTER**  
F4-451 29 cm, 11 1/2"

With removable jaws



**WOLFF SPREADER PLASTER**  
F4-452 18 cm, 7"  
F4-453 24 cm, 9 1/2"



**ENGEL PLASTER SAW**  
F4-454 14 cm, 5 1/2"



**CHARRIERE PLASTER SAW**  
F4-455 25 cm, 10"  
F4-456 27 cm, 10 3/4"  
Double saw





**STANDARD OPERATING  
SUPER CUT SCISSORS**



<b>F4-457</b> 14.5 cm 5 3/4" <b>F4-458</b> 16.5 cm 6 1/2" Str. B/B	<b>F4-459</b> 14.5 cm 5 3/4" <b>F4-460</b> 16.5 cm 6 1/2" Str. S/B	<b>F4-461</b> 14.5 cm 5 3/4" <b>F4-462</b> 16.5 cm 6 1/2" Str. S/S
--	--	--



**STANDARD OPERATING  
SUPER CUT SCISSORS**

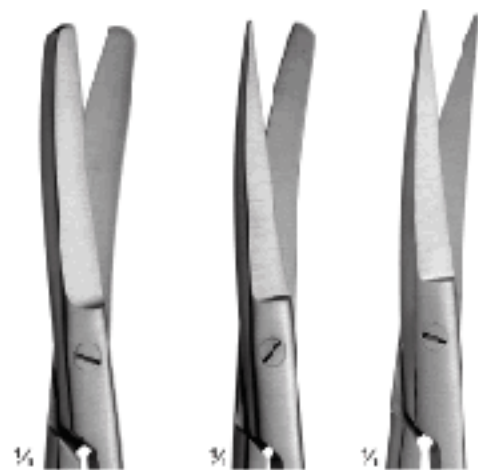

<b>F4-453</b> 14.5 cm 5 3/4" <b>F4-454</b> 16.5 cm 6 1/2" Cvd. B/B	<b>F4-455</b> 14.5 cm 5 3/4" <b>F4-456</b> 16.5 cm 6 1/2" Cvd. S/B	<b>F4-467</b> 14.5 cm 5 3/4" <b>F4-468</b> 16.5 cm 6 1/2" Cvd. S/S
--	--	--



**LAXER OPERATING SUPER  
CUT SCISSORS**



**F4-469** 16 cm 6 1/4"  
**F4-470** 21 cm 8 1/4"  
B/B, Str.



**F4-471** 18.5 cm 5 1/2"  
**F4-472** 21 cm 8 1/4"  
B/B, Cvd.



## SUPER CUT SCISSORS

<i>Super Cut Schere</i>	<i>Ciseaux SuperCut</i>
<i>Súper Cut Tijeras</i>	<i>Forbici SuperCut</i>



**SAFETY SUPER CUT SCISSORS**  
**F4-473** Str.  
**F4-474** Cvd.  
 6.0 cm, 3 1/2", Probe Ends



**GOLDMAN-FOX  
 SUPER CUT SCISSORS**  
**F4-475** Str.  
**F4-476** Cvd.  
 6.0 cm, 3 1/2", S/S  
 13 cm 5"



**STEVENS TENOTOMY  
 SUPER CUT SCISSORS**  
**F4-477** Str.  
**F4-478** Cvd.  
 9.0 cm, 3 1/2", E/B



**STEVENS TENOTOMY  
 SUPER CUT SCISSORS**  
**F4-479** Str.  
**F4-480** Cvd.  
 11.5 cm, 4 1/2", S/S



**BABY METZENBAUM  
 SUPER CUT SCISSORS**  
**F4-481** 11.5 cm, 4 1/2"  
 B/B, Str



**BABY METZENBAUM  
 SUPER CUT SCISSORS**  
**F4-482** 11.5 cm, 4 1/2"  
 B/B Cvd.



**IRIS SUPER CUT SCISSORS**  
**F4-483** 9.0 cm, 3 1/2"  
**F4-484** 11.5 cm, 4 1/2"  
 S/S, Str



**IRIS SUPER CUT SCISSORS**  
**F4-485** 9.0 cm, 3 1/2"  
**F4-486** 11.5 cm, 4 1/2"  
 S/S, Cvd.

**Operating Scissors, S/S Str.  
T/C Insert**

TCF4-487	11.5 cm, 4 1/2"
TCF4-488	13.0 cm, 5"
TCF4-489	14.0 cm, 5 1/2"
TCF4-490	15.0 cm, 6"
TCF4-491	16.0 cm, 6 1/2"
TCF4-492	17.5 cm, 7"
TCF4-493	18.5 cm, 7 1/2"
TCF4-494	20.0 cm, 8"

**Operating Scissors, S/S Cvd.  
T/C Insert**

TCF4-495	11.5 cm, 4 1/2"
TCF4-496	13.0 cm, 5"
TCF4-497	14.0 cm, 5 1/2"
TCF4-498	15.0 cm, 6"
TCF4-499	16.0 cm, 6 1/2"
TCF4-500	17.5 cm, 7"
TCF4-501	18.5 cm, 7 1/2"
TCF4-502	20.0 cm, 8"

**Operating Scissors, B/B Str.  
T/C Insert**

TCF4-503	11.5 cm, 4 1/2"
TCF4-504	13.0 cm, 5"
TCF4-505	14.0 cm, 5 1/2"
TCF4-506	15.0 cm, 6"
TCF4-507	16.0 cm, 6 1/2"
TCF4-508	17.5 cm, 7"
TCF4-509	18.5 cm, 7 1/2"
TCF4-510	20.0 cm, 8"

**Operating Scissors, B/B Cvd.  
T/C Insert**

TCF4-511	11.5 cm, 4 1/2"
TCF4-512	13.0 cm, 5"
TCF4-513	14.0 cm, 5 1/2"
TCF4-514	15.0 cm, 6"
TCF4-515	16.0 cm, 6 1/2"
TCF4-516	17.5 cm, 7"
TCF4-517	18.5 cm, 7 1/2"
TCF4-518	20.0 cm, 8"

**Operating Scissors, S/D  
Standard Str. T/C Insert**

TCF4-519	11.5 cm, 4 1/2"
TCF4-520	13.0 cm, 5"
TCF4-521	14.0 cm, 5 1/2"
TCF4-522	15.0 cm, 6"
TCF4-523	16.0 cm, 6 1/2"
TCF4-524	17.5 cm, 7"
TCF4-525	18.5 cm, 7 1/2"
TCF4-526	20.0 cm, 8"

**Operating Scissors, S/D  
Standard Cvd. T/C Insert**

TCF4-527	11.5 cm, 4 1/2"
TCF4-528	13.0 cm, 5"
TCF4-529	14.0 cm, 5 1/2"
TCF4-530	15.0 cm, 6"
TCF4-531	16.0 cm, 6 1/2"
TCF4-532	17.5 cm, 7"
TCF4-533	18.5 cm, 7 1/2"
TCF4-534	20.0 cm, 8"

**Metzenbaum Operating Scissors T/C Insert**

**TCF4-535**  
11.5 cm 4 1/2"  
**TCF4-536**  
14.5 cm 5 3/4"  
B/B Str.

**TCF4-537**  
11.5 cm 4 1/2"  
**TCF4-538**  
14.5 cm 5 3/4"  
S/B Str.

**TCF4-539**  
11.5 cm 4 1/2"  
**TCF4-540**  
14.5 cm 5 3/4"  
S/S Str.

**TCF4-541**  
11.5 cm 4 1/2"  
**TCF4-542**  
14.5 cm 5 3/4"  
B/B Cvd.

**TCF4-543**  
11.5 cm 4 1/2"  
**TCF4-544**  
14.5 cm 5 3/4"  
S/B Cvd.

**TCF4-545**  
11.5 cm 4 1/2"  
**TCF4-546**  
14.5 cm 5 3/4"  
S/S Cvd.

**Metzenbaum Operating Scissors T/C Insert**

**TCF4-547**  
18 cm 7"  
**TCF4-548**  
20 cm 8"  
**TCF4-549**  
23 cm 9"  
**TCF4-550**  
25 cm 10"  
**TCF4-551**  
28 cm 11"  
**TCF4-552**  
30 cm 12"  
E/B Str.

**TCF4-553**  
18 cm 7"  
**TCF4-554**  
20 cm 8"  
**TCF4-555**  
23 cm 9"  
**TCF4-556**  
25 cm 10"  
**TCF4-557**  
28 cm 11"  
**TCF4-558**  
30 cm 12"  
S/B Str.

**TCF4-559**  
18 cm 7"  
**TCF4-560**  
20 cm 8"  
**TCF4-561**  
23 cm 9"  
**TCF4-562**  
25 cm 10"  
**TCF4-563**  
28 cm 11"  
**TCF4-564**  
30 cm 12"  
S/S Str.

**TCF4-565**  
18 cm 7"  
**TCF4-566**  
20 cm 8"  
**TCF4-567**  
23 cm 9"  
**TCF4-568**  
25 cm 10"  
**TCF4-569**  
28 cm 11"  
**TCF4-570**  
30 cm 12"  
B/B Cvd.

**TCF4-571**  
18 cm 7"  
**TCF4-572**  
20 cm 8"  
**TCF4-573**  
23 cm 9"  
**TCF4-574**  
25 cm 10"  
**TCF4-575**  
28 cm 11"  
**TCF4-576**  
30 cm 12"  
S/B Cvd.

**TCF4-577**  
18 cm 7"  
**TCF4-578**  
20 cm 8"  
**TCF4-579**  
23 cm 9"  
**TCF4-580**  
25 cm 10"  
**TCF4-581**  
28 cm 11"  
**TCF4-582**  
30 cm 12"  
S/S Cvd.

**Metzenbaum-Nelson Operating Scissors T/C Insert**

**Metzenbaum-Nelson Operating Scissors T/C Insert**

 $\frac{1}{4}$ 

**TCF4-583** 14.5 cm 5 3/4"  
**TCF4-584** 18 cm 7"  
**TCF4-585** 20 cm 8"  
**TCF4-586** 23 cm 9"  
 B/B Str.

 $\frac{1}{4}$ 

**TCF4-587** 14.5 cm 5 3/4"  
**TCF4-588** 18 cm 7"  
**TCF4-589** 20 cm 8"  
**TCF4-590** 23 cm 9"  
 B/B Cvd.

 $\frac{1}{4}$ 

**TCF4-591** 14.5 cm 5 3/4"  
**TCF4-592** 18 cm 7"  
**TCF4-593** 20 cm 8"  
**TCF4-594** 23 cm 9"  
 S/S Str.

 $\frac{1}{4}$ 

**TCF4-595** 14.5 cm 5 3/4"  
**TCF4-596** 18 cm 7"  
**TCF4-597** 20 cm 8"  
**TCF4-598** 23 cm 9"  
 S/S Cvd.

**Metzenbaum-Fine**  
**Operating Scissors**  
**T/C Insert**

**Metzenbaum-Fine**  
**Operating Scissors**  
**T/C Insert**

 $\frac{1}{4}$ 

**TCF4-599** 14.5 cm 5 1/2"  
**TCF4-600** 15.0 cm 6"  
**TCF4-601** 17.0 cm 6 1/2"  
**TCF4-602** 23.0 cm 9"  
 B/B Str.

 $\frac{1}{4}$ 

**TCF4-603** 14.5 cm 5 1/2"  
**TCF4-604** 15.0 cm 6"  
**TCF4-605** 17.0 cm 6 1/2"  
**TCF4-606** 23.0 cm 9"  
 B/B Cvd.

 $\frac{1}{4}$ 

**TCF4-607** 15.0 cm 6"  
**TCF4-608** 17.0 cm 6 1/2"  
**TCF4-609** 19.5 cm 7 1/2"  
**TCF4-610** 21.0 cm 8 1/2"  
 B/B Str.

 $\frac{1}{4}$ 

**TCF4-611** 15.0 cm 6"  
**TCF4-612** 17.0 cm 6 1/2"  
**TCF4-613** 19.5 cm 7 1/2"  
**TCF4-614** 21.0 cm 8 1/2"  
 B/B Cvd.

**Mayo Dissecting &**  
**Gynecological Scissors**  
**T/C Insert**

**Mayo-stille Dissecting &**  
**Gynecological Scissors**  
**T/C Insert**



**ENT-JEAN SCISSORS**  
TCF4-615 17 cm, 6 3/4"  
S/S Double Cvd.  
Serrated



**KELLY OPERATING,  
DISSECTING SCISSORS**

TCF4-616  
16.0 cm, 6 1/4"  
TCF4-617  
18.0 cm, 7"  
S/S Str.

TCF4-618  
16.0 cm 6 1/4"  
TCF4-619  
18.0 cm 7"  
S/S Cvd.



**Goldmann-Fox  
Operating Scissors**  
T/C Insert

TCF4-620  
13 cm 5"  
S/S Str.

TCF4-621  
13 cm 5"  
S/S Cvd.



**WIRE CUTTING SCISSORS**  
TCF4-522 12 cm, 4 3/4"



**Lister Bandage Plaster  
Scissors T/C Insert, one large ring**  
TCF4-523 8.9cm 3 1/2"  
TCF4-524 11.43 cm, 4.5"  
TCF4-525 14 cm 5 1/2"  
TCF4-526 16 cm 6 1/4"  
TCF4-527 18 cm 7"  
TCF4-528 20 cm 8"

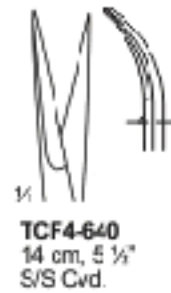
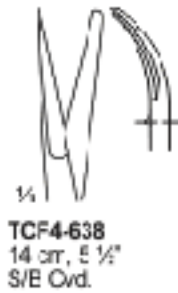
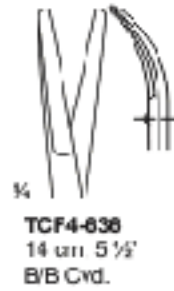

**Lister Bandage Plaster  
Scissors, T/C Insert**  
TCF4-629 8.9cm, 3 1/2"  
TCF4-630 11.43 cm, 4.5"  
TCF4-631 14 cm, 5 1/2"  
TCF4-632 16 cm, 6 1/4"  
TCF4-633 18 cm, 7"  
TCF4-634 20 cm, 8"

**Castrovillejo Scissors**  
 T/C Insert

**Joseph Operating**  
 Scissors T/C Insert

**Reynolds Operating**  
 Scissors T/C Insert

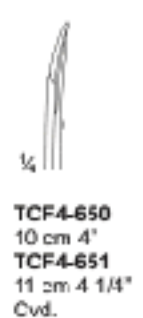
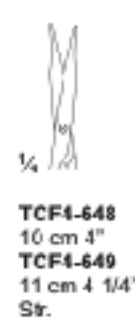
**Foman Operating**  
 Scissors T/C Insert  
**TCF4-647**  
 13 cm 5" Ful Bert

**Stevens Operating**  
 Scissors T/C Insert

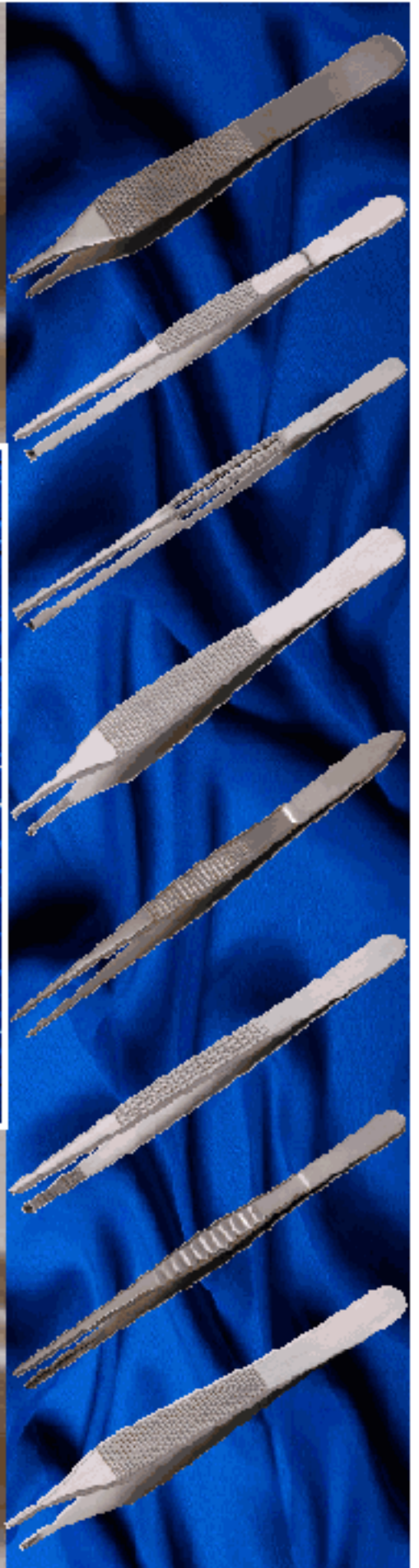
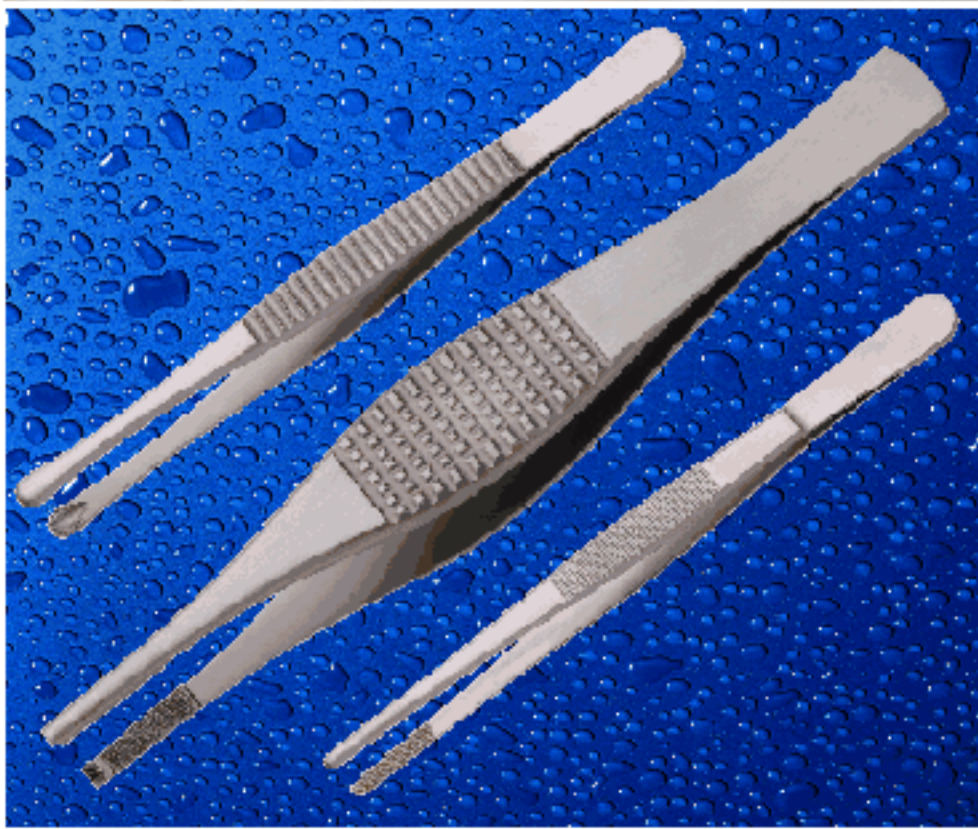

# DRESSING & TISSUE FORCEPS







## DRESSING FORCEPS, TISSUE FORCEPS

Anatomische pinzetten, chirurgische pinzetten

Pincers à dissection, pincers à griffes

Pinzas de disección, pinzas de disección concidentes

Pinze Anatomiche per dissezioni, pinze chirurgiche a dentidtopo



**F5-001**  
10.5 cm, 4 1/4"  
serrated



**F5-002**  
11.5 cm, 4 1/2"  
serrated



**F5-003**  
13 cm, 5"  
serrated

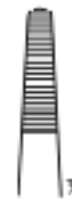

**F5-004**  
14.5 cm, 5 3/4"  
serrated



**F5-005**  
18 cm 6 1/4"  
serrated



**F5-006**  
18 cm, 7"  
serrated



**F5-007**  
20 cm, 8"  
serrated

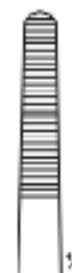

**F5-008**  
25 cm, 10"  
serrated



**F5-009**  
30 cm, 12"  
serrated

**STANDARD  
DRESSING  
FORCEPS**



**F5-010**  
10.5 cm, 4 1/4"



**F5-011**  
11.5 cm, 4 1/2"



**F5-012**  
13 cm 5"



**F5-013**  
14.5 cm 5 3/4"



**F5-014**  
16 cm 6 1/4"



**F5-015**  
18 cm, 7"



**F5-016**  
20 cm, 8"



**F5-017**  
25 cm, 10"



**F5-018**  
30 cm 12"

**STANDARD TISSUE  
FORCEPS 1x2 teeth**



# TISSUE & DRESSING FORCEPS

*Pinzas para tejidos, Pinzas à dissection*  
*Pinze per tessuti, Pinze per dissezione*

*Pinzas a tissu, Anatomische pinzetten*  
*Gewebe, Pinzas de disección*



- Mod. USA Tissue Forceps**  
1x2 teeth
- F5-019 10.2 cm, 4"
  - F5-020 11.4 cm, 4.5"
  - F5-021 12.7 cm, 5"
  - F5-022 14.0 cm, 5.5"
  - F5-023 15.2 cm, 6"
  - F5-024 17.8 cm, 7"
  - F5-025 20.3 cm, 8"
  - F5-026 25.4 cm, 10"
  - F5-027 30.5 cm, 12"



- Mod. USA Dressing Forceps serrated**
- F5-028 12 cm, 4 3/4"
  - F5-029 13 cm, 5"
  - F5-030 14.5 cm, 5 3/4"
  - F5-031 15.5 cm, 6"
  - F5-032 18 cm, 7"
  - F5-033 21 cm, 8 1/4"
  - F5-034 25 cm, 10"
  - F5-035 31 cm, 12 1/4"



- MOD. MARTIN Dressing Forceps**
- F5-036 12.7 cm, 5"
  - F5-037 14.0 cm, 5.5"



- Standard Dressing Forceps Curved serrated**
- F5-038 11.4 cm, 4.5"
  - F5-039 12.7 cm, 5"
  - F5-040 14.0 cm, 5.5"
  - F5-041 15.2 cm, 6"
  - F5-042 17.8 cm, 7"
  - F5-043 20.3 cm, 8"
  - F5-044 25.4 cm, 10"
  - F5-045 30.5 cm, 12"



- Standard Dressing Forceps wide pattern cross serration**
- F5-046 11.4 cm, 4.5"
  - F5-047 12.7 cm, 5"
  - F5-048 14.0 cm, 5.5"
  - F5-049 15.2 cm, 6"
  - F5-050 17.0 cm, 7"
  - F5-051 20.3 cm, 8"
  - F5-052 25.4 cm, 10"
  - F5-053 30.5 cm, 12"



- Standard Dressing Forceps Narrow Point**
- F5-054 12.7 cm, 5" serrated
  - F5-055 14 cm, 5.5" serrated
  - F5-056 15.20 cm, 6" serrated
  - F5-057 17.0 cm, 7" serrated
  - F5-058 20.3 cm, 8" serrated
  - F5-059 25.4 cm, 10" serrated
  - F5-060 30.5 cm, 12" serrated



- SEMKEN Dressing Forceps straight serrated**
- F5-061 12.5 cm, 5"
  - F5-062 15.6 cm, 6"



- SEMKEN Dressing Forceps curved serrated**
- F5-063 12.5 cm, 5"
  - F5-064 15.5 cm, 6"

*Pinces a tissu, Anatomische pinzetten*  
*Gewebe, Pinzas de disección*

*Pinzas para tejidos, Pincas à dissection*  
*Pinze per tessuti, Pinze per dissezione*



**POTTS-SMITH Dressing Forceps**  
**F5-065** 17.5 cm, 7"  
**F5-066** 21.0 cm, 8 1/4"  
**F5-067** 25.0 cm, 10"  
 straight serrated



**POTTS-SMITH Dressing Forceps**  
**F5-463** 17.5 cm, 7"  
**F5-469** 21.0 cm, 8 1/4"  
**F5-470** 25.0 cm, 10"  
 curved serrated



**POTTS-SMITH Tissue Forceps 1x2 teeth**  
**F5-071** 17.5 cm, 7"  
**F5-072** 21.0 cm, 8 1/4"  
**F5-073** 25.0 cm, 10"  
 straight



**POTTS-SMITH Tissue Forceps 1x2 teeth**  
**F5-074** 17.5 cm, 7"  
**F5-075** 21.0 cm, 8 1/4"  
**F5-076** 25.0 cm, 10"  
 curved



**Brophy Dressing Forceps**  
**F6-077** 20.0 cm, 8"  
 straight serrated



**Brophy Dressing Forceps**  
**F6-078** 20.0 cm, 8"  
 curved serrated



**Brophy Tissue Forceps 1x2 teeth**  
**F6-079** 20.0 cm, 8"  
 straight serrated

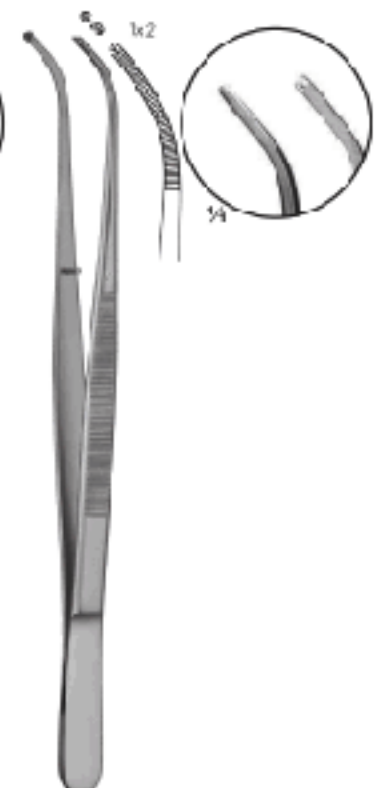

**Brophy Tissue Forceps 1x2 teeth**  
**F6-080** 20.0 cm, 8"  
 curved serrated

*Pinzas para tejidos, Pinzas à dissection*  
*Pinze per tessuti, Pinze per dissezione*

*Pincas a tissiu, Anatomische pinzetten*  
*Gewebe, Pinzas de disección*



**WANGENSTEEN**  
**Dressing Forceps**  
**F5-081 23 cm, 9"**



**Stone Tissue Forceps**  
**4X5 Teeth**  
**F5-082 15.2 cm, 5"**



**Lerche Tissue Forceps**  
**5X6 Teeth**  
**F5-083 15 cm, 6"**



**Adlerkreutz Tissue**  
**Forceps 2X3 Teeth**  
**F6-384 16 cm, 6"**  
**F6-385 20 cm, 8"**



**Adlerkreutz Tissue**  
**Forceps 4X5 Teeth**  
**F6-086 15 cm, 6"**  
**F6-087 20 cm, 8"**



**Gillico Tissue Forceps**  
**1X2 Teeth**  
**F6-088 16 cm, 6"**  
**straight serrated**



**Gillico Tissue Forceps**  
**1X2 Teeth**  
**F6-089 16 cm, 6"**  
**curved serrated**

*Pinzas para tejidos, Pinzas à dissection*  
*Pinze per tessuti, Pinze per dissezione*

*Pinças a tissú, Anatomische pinzetten*  
*Gewebe, Pinzas de disección*

**Tissue Forceps 2x3 Teeth**

- F5-090 11.4 cm 4 1/2"
- F5-091 13.0 cm 5"
- F5-092 14.5 cm 5 3/4"
- F5-093 16.0 cm 6 1/4"
- F5-094 17.5 cm 7"
- F5-095 20.0 cm 8"
- F5-096 25.0 cm 10"
- F5-097 30.0 cm 12"

**Tissue Forceps 3x4 Teeth**

- F5-098 11.4 cm 4 1/2"
- F5-099 12.7 cm 5"
- F5-100 14 cm 5 1/2"
- F5-101 15.9 cm 6 1/4"
- F5-102 17.8 cm 7"
- F5-103 20.3 cm 8"
- F5-104 25.4 cm 10"
- F5-105 30.5 cm 12"

**Tissue Forceps 4x5 Teeth**

- F5-106 11.4 cm 4 1/2"
- F5-107 12.7 cm 5"
- F5-108 14 cm 5 1/2"
- F5-109 15.9 cm 6 1/4"
- F5-110 17.8 cm 7"
- F5-111 20.3 cm 8"
- F5-112 25.4 cm 10"
- F5-113 30.5 cm 12"



**Iris Tissue Forceps**  
**F5-114 10.2 cm, 4"**  
 1x2 Tooth, Straight



**Iris Tissue Forceps**  
**F5-115 10.2 cm, 4"**  
 1x2 Tooth, Half Curved



**Iris Tissue Forceps**  
**F5-116 10.2 cm, 4"**  
 1x2 Tooth, Full Curved

*Pinzas para tejidos, Pinzas à dissection*  
*Pinze per tessuti, Pinze per dissezione*

*Pincas a tissu, Anatomische pinzetten*  
*Gewebe, Pinzas de disección*



**Waugh Dressing Forceps**  
**F5-117** 15.0 cm, 6"  
**F5-118** 18.0 cm, 7"  
 slightly heavier  
 non-toothed,  
 serrated jaws.



**Waugh Tissue Forceps**  
**1x2 Teeth**  
**F5-119** 15.0 cm, 6"  
**F5-120** 18.0 cm, 7"  
 as above but one two  
 tooth on serrated jaws.  
 Known as Scott.



**Laedham Tissue Forceps**  
**1x2 Teeth**  
**F5-121** 14.5 cm, 5.75"  
**F5-122** 18.0 cm, 7"  
 Green Dissacing  
 Forceps two three  
 teeth, smooth jaws.



**Treves Tissue Forceps**  
**1x2 Teeth**  
**F5-123** 12.5 cm, 5"  
**F5-124** 15.0 cm, 6"  
**F5-125** 13.0 cm, 7"  
 Dissacing Forceps  
 teeth, on smooth jaws.



**Charnley Tissue Forceps**  
**1x2 Teeth**  
**F5-126** 14.5 cm, 5 1/2"  
**F5-127** 18.0 cm, 7"  
 Dissacing Forceps  
 one into two tooth,  
 block on jaws.



**Ramsay Dissecting Forceps**  
**F5-128** 18.0 cm, 7"  
 serrated jaws.



**Ramsay Tissue Forceps**  
**1x2 Teeth**  
**F5-129** 18.0 cm, 7"  
 Dissecting Forceps  
 one into tooth on  
 serrated jaws.



**Dissecting Dressing  
 Forceps**  
**F5-130** 12.5 cm, 5"  
**F5-131** 15.0 cm, 6"  
**F5-132** 18.0 cm, 7"  
 turn over end,  
 serrated jaws.



**Dissecting Dressing  
 Forceps**  
**F5-133** 12.5 cm, 5"  
**F5-134** 15.0 cm, 5"  
**F5-135** 18.0 cm, 7"  
**F5-136** 20.0 cm, 8"  
 block end, serrated  
 jaws.

*Pinces a tissu, Anatomische pinzetten*  
*Gewebe, Pinzas de disección*

*Pinzas para tejidos, Pincers à dissection*  
*Pinze per tessuti, Pinze per dissezione*

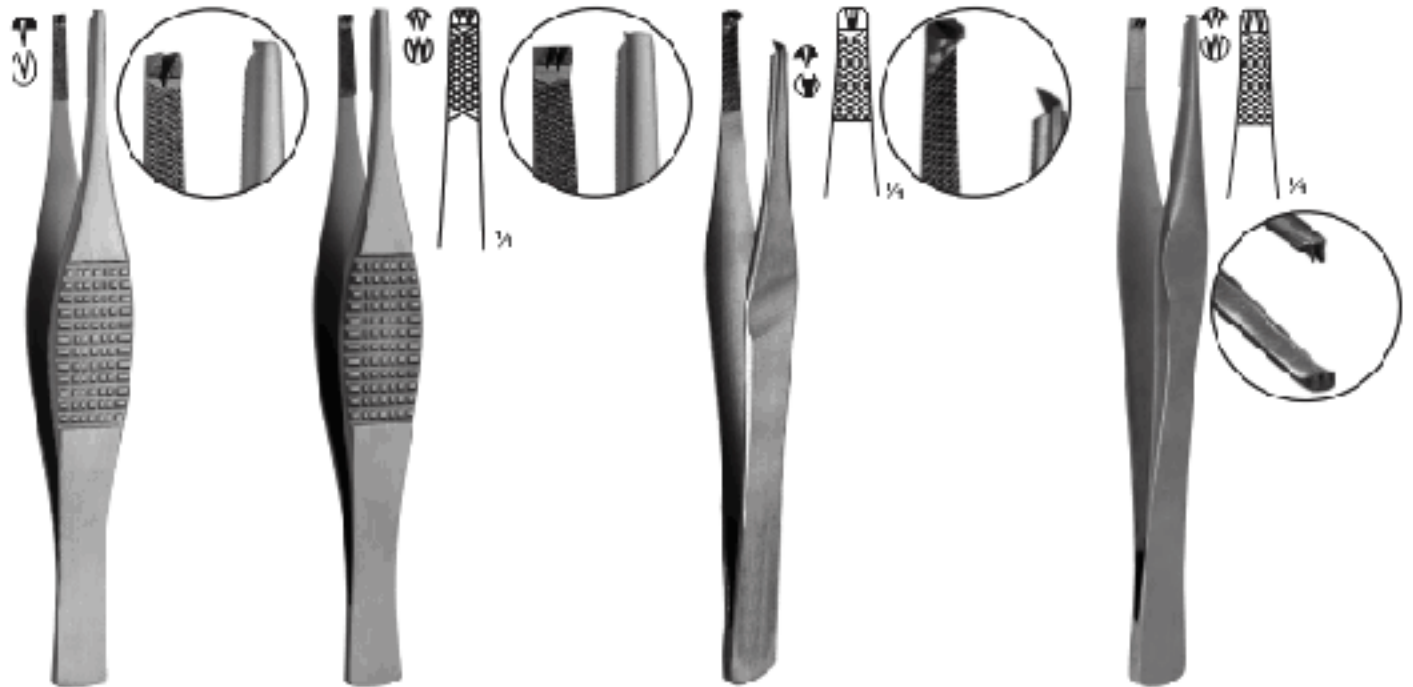

**Ferris-Smith Tissue Forceps 1x2 Teeth**  
**F5-137**  
 18 cm, 7"

**Ferris-Smith Tissue Forceps 2x3 Teeth**  
**F5-138**  
 18 cm, 7"

**Lane Tissue Forceps 1x2 Teeth**  
**F5-139** 12.5cm, 5 1/2"  
**F5-140** 15 cm, 6"  
**F5-141** 17 cm, 6 3/4"  
**F5-142** 18 cm, 7"  
**F5-143** 20 cm, 8"

**Lane Tissue Forceps 2x3 Teeth**  
**F5-144** 12.5cm, 5 1/2"  
**F5-145** 15 cm, 6"  
**F5-146** 17 cm, 6 3/4"  
**F5-147** 18 cm, 7"  
**F5-148** 20 cm, 8"

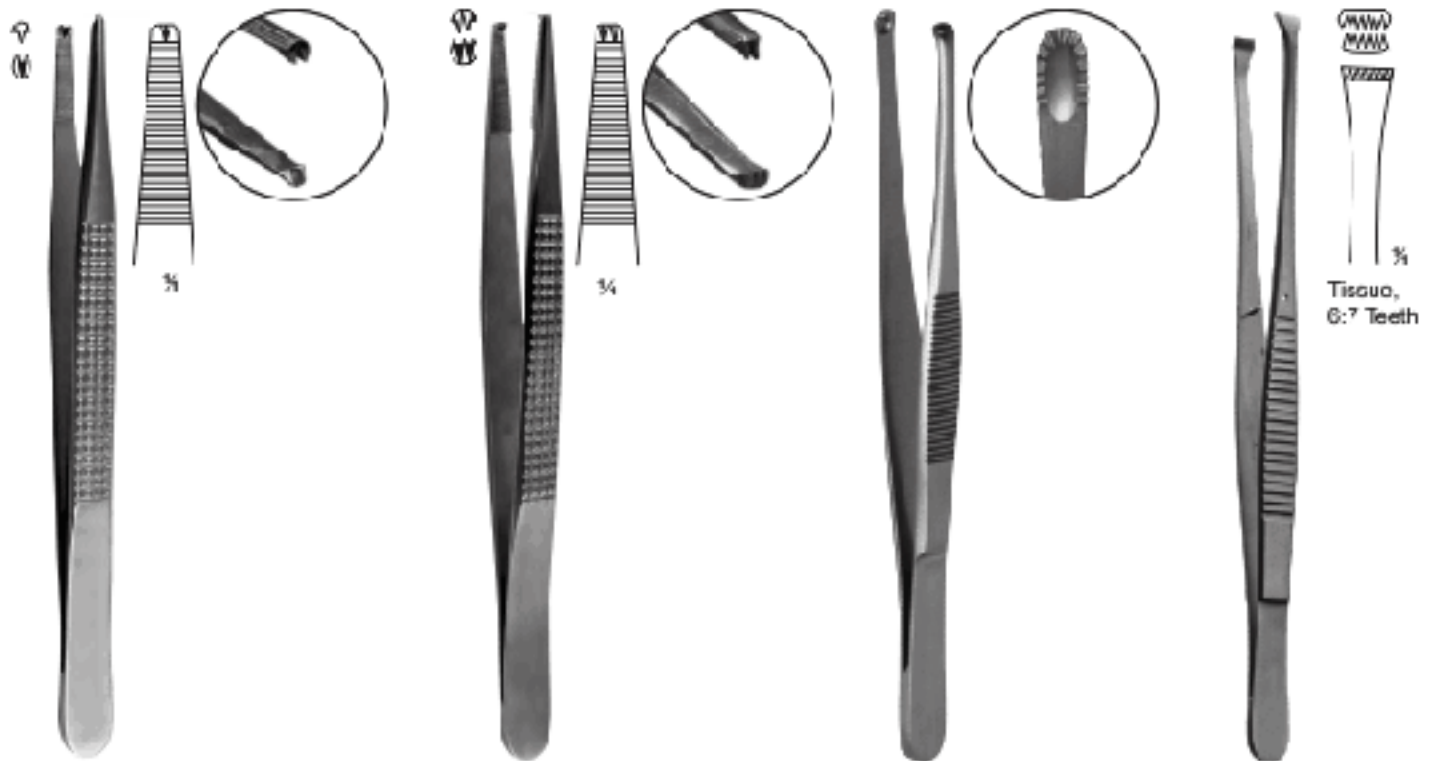

**Bonney Tissue Forceps 1x2 Teeth**  
**F5-149**  
 10 cm, 7"

**Bonney Tissue Forceps 2x3 Teeth**  
**F5-150**  
 10 cm, 7"

**Durante Tissue Grasping Forceps**  
**F5-151** 14.5cm, 5 3/4"  
**F5-152** 16 cm, 6 1/4"  
**F5-153** 20 cm, 8"

**Nelson Tissue Forceps F5-154** 20 cm, 9"  
 6x7 Teeth

*Pinzas para tejidos, Pinzas à dissection*  
*Pinze per tessuto, Pinze per dissezione*

*Pinces a tissu, Anatomische pinzetten*  
*Gewebe, Pinzas de disección*



**Russian-Modell  
Tissue Forceps**  
 F5-155 15 cm, 6"  
 F5-156 21 cm, 8"  
 F5-157 25 cm, 10"



**Singley-Tuttle  
Forceps**  
 F5-158  
 23 cm, 9"



**Collin-Duval  
Forceps**

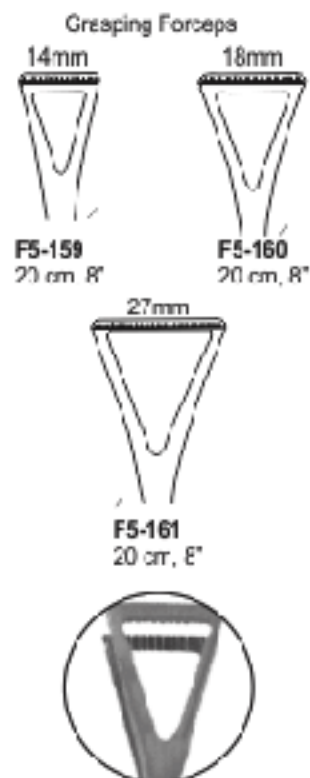

**Stille-Barraya Tissue  
Forceps 3x4 Teeth**  
 F5-162 18 cm, 7"  
 F5-163 20 cm, 8"  
 F5-164 25 cm, 10"



**Duehrssen Dressing  
Forceps**  
 F5-165 20 cm, 8"  
 Serralec



**Duehrssen Tissue  
Forceps 1x2 Teeth**  
 F5-166  
 23 cm, 8"



**Duehrssen Tissue  
Forceps 2x3 Teeth**  
 F5-167  
 20 cm, 8"



*Pinzas para tejidos, Pinzas à dissection*  
*Pinze per tessuti, Pinze per dissezione*

*Pinces a tissu, Anatomische pinzetten*  
*Gewebe, Pinzas de disección*

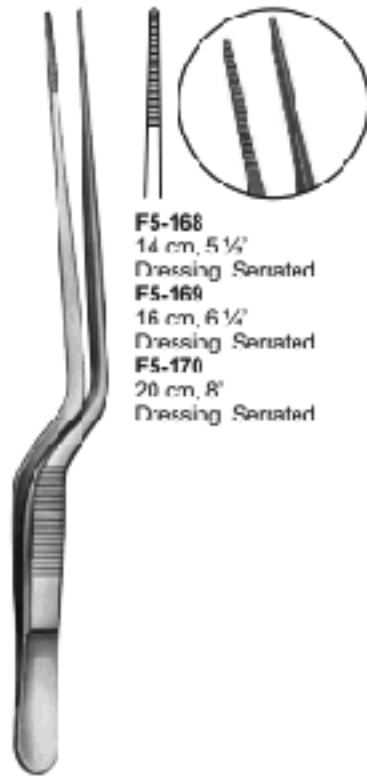

**F5-168**  
 14 cm, 5 1/2"  
 Dressing Serrated  
**F5-169**  
 16 cm, 6 1/4"  
 Dressing Serrated  
**F5-170**  
 20 cm, 8"  
 Dressing Serrated

**LUCAE / ENT**  
 Dressing Forceps



**Paper Dressing**  
**Forceps**  
**F5-171** 15 cm, 6"



**Paper Dressing**  
**Forceps**  
**F5-172** 15 cm, 6"



**Paper Dressing**  
**Forceps**  
**F5-173** 15 cm, 6"  
 Curved



**Hunt Tumor and**  
**Vessel Forceps**  
**F5-174**  
 20 cm, 8"



**F5-175**  
 24 cm, 9 1/2"  
 3mm hole

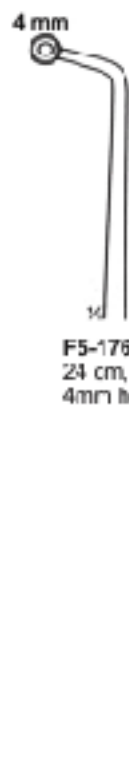

**F5-176**  
 24 cm, 9 1/2"  
 4mm hole



**F5-177**  
 24 cm, 9 1/2"  
 5mm hole



**F5-178**  
 24 cm, 9 1/2"  
 3mm hole

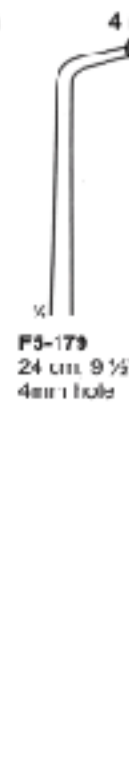

**F5-179**  
 24 cm, 9 1/2"  
 4mm hole

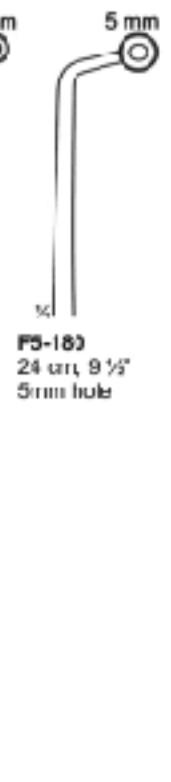

**F5-180**  
 24 cm, 9 1/2"  
 5mm hole

**Semil Forceps**  
 Spoon-Shaped Jaws Left  
 24 cm, 9 1/2"

**Samii Forceps**  
 Spoon-Shaped Jaws Right  
 24 cm, 9 1/2"



**F5-181** regular point straight  
**F5-182** fine point straight  
**F5-183** micro point straight  
 12 cm, 4 3/4" 1x2 Teeth



**F5-187** regular point curved  
**F5-188** fine point curved  
**F5-189** micro point curved  
 12 cm, 4 3/4" 1x2 Teeth



**F5-184** regular point with platform straight  
**F5-185** fine point with platform straight  
**F5-186** micro point with platform straight  
 12 cm, 4 3/4" 1x2 Teeth



**F5-190** regular point straight  
**F5-191** fine point straight  
**F5-192** micro point straight  
 12 cm, 4 3/4" 1x2 Teeth



**F5-193** regular point straight  
**F5-194** fine point straight  
 Forceps, 12cm 4 3/4"  
 9x8 teeth



**F5-195** regular point, Curved  
**F5-196** fine point, Curved  
 Forceps, 12cm 4 3/4"  
 9x9 teeth

**Adson Tissue Forceps**  
 Curved Point

**Adson Brown Tissue**



**F5-197** regular point straight  
**F5-198** fine point straight  
**F5-199** micro point straight  
 12 cm, 4 3/4" 1x2 Teeth



**F5-203** regular point curved  
**F5-204** fine point curved  
**F5-205** micro point curved  
 12 cm, 4 3/4" 1x2 Teeth



**F5-200** regular point with platform straight  
**F5-201** fine point with platform straight  
**F5-202** micro point with platform straight  
 12 cm, 4 3/4" 1x2 Teeth



**F5-206** regular point curved  
**F5-207** fine point curved  
**F5-208** micro point curved  
 12 cm, 4 3/4" 1x2 Teeth



**F5-209** regular point, straight  
**F5-210** fine point straight  
 12cm 4 3/4"  
 7x7 teeth



**F5-211** regular point, Curved  
**F5-212** fine point, Curved  
 12cm 4 3/4"  
 7x7 teeth

**Adson Tissue Forceps**  
 with fenestrated handle

**Adson Brown Tissue Forceps**  
 Fenestrated Handle

*Pincas a tissu, Anatomische pinzetten*  
*Ceweõe, Pinzas de disección*

*Pinzas para tejidos, Pincas à dissection*  
*Pinze per tessuti, Pinze per dissezione*



**Graefe Forceps**



**F5-213**  
7.0 cm, 2 3/4"  
**F5-214**  
10.0 cm, 4"  
straight:  
serrated



**F5-215**  
7.0 cm, 2 3/4"  
**F5-216**  
10.0 cm, 4"  
half curved  
serrated



**F5-217**  
7.0 cm, 2 3/4"  
**F5-218**  
10.0 cm, 4"  
full curved  
serrated



**F5-219** 1x2 teeth  
7.0 cm, 2 3/4"  
**F5-220** 1x2 teeth  
10.0 cm, 4"  
straight



**F5-221** 1x2 teeth  
7.0 cm, 2 3/4"  
**F5-222** 1x2 teeth  
10.0 cm, 4"  
half curved



**F5-223** 1x2 teeth  
7.0 cm, 2 3/4"  
**F5-224** 1x2 teeth  
10.0 cm, 4"  
full curved



**Stevens Tissue Forceps**  
1x2 Teeth



**F5-225**  
11.0 cm, 4 1/2"  
straight



**Stevens Tissue Forceps**  
1x2 Teeth



**F5-225**  
11.0 cm, 4 1/2"  
Curved



**Graefe Dressing Forceps**  
**F5-227** 0.5 mm  
**F5-228** 0.7 mm  
**F5-229** 1.0 mm  
7.0 cm, 3"  
straight serrated



**Graefe Dressing Forceps**  
**F5-230** 0.5 mm  
**F5-231** 0.7 mm  
**F5-232** 1.0 mm  
7.0 cm, 3"  
curved serrated



**Graefe Tissue Forceps**  
1x2 Teeth  
**F5-233** 0.5 mm  
**F5-234** 0.7 mm  
**F5-235** 1.0 mm  
7.0 cm, 3"  
straight



**Graefe Tissue Forceps**  
1x2 Teeth  
**F5-236** 0.5 mm  
**F5-237** 0.7 mm  
**F5-238** 1.0 mm  
7.0 cm, 3"  
curved



**Graefe Fixation Forceps**  
**F5-239**  
11.2 cm 4 3/8"  
standard jaws 4.5mm wide  
with fine teeth



# JEWELER TYPE, DISSECTING FORCEPS

*Chirurgische pinzetten, Uhrmacher-Pinzetten*

*Pinces à dissection à grosses, Pinces d'horloger*

*Pinzas de disección con dientes, Pinzas de relojero*

*Pinze per dissezione con denti, Pinze de orologiaio*



**Dumont Forceps**  
**F5-240** 11.5 cm, 4 1/2"  
curved



**F5-241**  
10.5 cm, 4"  
full curved



**F5-242**  
10.5 cm, 4"  
half curved



**F5-243**  
11 cm, 4 1/8"



**F5-244**  
11 cm, 4 1/8"  
fine point



**F5-245**  
11 cm, 4 1/8"  
extra fine point



**F5-246**  
12 cm, 5"  
fine point



**F5-247**  
12 cm, 5"  
extra fine point



**F5-248**  
12 cm 5"



**Dumont Forceps**  
**F5-249**  
style 1, fine point,  
12.1 cm 4 3/4"



**Dumont Forceps**  
**F5-250**  
style 2, strong  
fine point,  
12.1 cm 4 3/4"



**Dumont Forceps**  
**F5-251**  
style 3, narrow  
fine point,  
12.1 cm 4 3/4"



**Dumont Forceps**  
**F5-252**  
style 3C, narrow  
fine point,  
11.2 cm 4 3/8"



## JEWELER TYPE, DISSECTING FORCEPS

*Chirurgische pinzetten, Uhrmacher-Pinzetten*

*Pinces à dissection à grosses, Pinces d'horloger*

*Pinzas de disección con dientes, Pinzas de relojero*

*Pinze per dissezione con denti, Pinze de orologiaio*



**Dumont Forceps  
F5-253**  
style 4, fine point,  
11.2cm 4 3/8"



**Dumont Forceps  
F5-254**  
style 5, super fine  
11.2cm point, 4 3/8"



**Dumont Forceps  
F5-255**  
style 5, micro fine  
11.2cm point, 4 3/8"



**Dumont Forceps  
F5-256**  
style 6, pick up,  
11.4 cm 4 1/2"



**Dumont Forceps  
F5-257**  
style 7, fine curved,  
11.4 cm 4 1/2"



**Dumont Forceps  
F5-258**  
style 7, micro fine  
11.4 cm curved, 4 1/2"

*Cilienpinzetten*  
*Pinzas depilatorias*

*Pinces à épiler les cils*  
*Pinze depilatoria*



**Ziegler Cilia Forceps**  
F5-259  
9 cm, 3 1/2"



**Douglas Cilia Forceps**  
F5-260  
9 cm, 3 1/2"



**Beer Cilia Forceps**  
F5-261  
9 cm, 3 1/2"



**Gracie Cilia Forceps**  
F5-262  
10.5cm, 4"



**Kuehne Cilia Forceps**  
F5-263  
10.6cm, 4"



**Kushne Cilia Forceps**  
F5-264  
10.5cm, 4"  
angled sideways



**Barrquer Cilia Forceps**  
F5-265  
10.5cm, 4"



**Littauer Cilia Forceps**  
F5-266  
8.5 cm, 3"



**Littauer Cilia Forceps**  
F5-267  
9 cm, 3 1/2"

*Splitterpinzetten*  
*Pinzas Para espinas*
*Pincers à écharde*  
*Pinze per scheggie*

**Splinter Forceps**

**F5-263** 8 cm, 3"  
**F5-269** 9 cm, 3 1/2"  
**F5-270** 10.5 cm, 4"  
**F5-271** 11.5 cm, 4 1/2"  
**F5-272** 12.5 cm, 5"  
**F5-273** 14.5 cm, 5 1/2"  
 Straight Plain

**Splinter Forceps**

**F5-274** 8 cm, 3"  
**F5-275** 9 cm, 3 1/2"  
**F5-276** 10.5 cm, 4"  
**F5-277** 11.5 cm, 4 1/2"  
**F5-278** 12.5 cm, 5"  
**F5-279** 14.5 cm, 5 1/2"  
 Curved Plain

**Splinter Forceps**

**F5-280** 8 cm, 3"  
**F5-281** 9 cm, 3 1/2"  
**F5-282** 10.5 cm, 4"  
**F5-283** 11.5 cm, 4 1/2"  
**F5-284** 12.5 cm, 5"  
**F5-285** 14.5 cm, 5 1/2"  
 Straight serrated

**Splinter Forceps**

**F5-286** 8 cm, 3"  
**F5-287** 9 cm, 3 1/2"  
**F5-288** 10.5 cm, 4"  
**F5-289** 11.5 cm, 4 1/2"  
**F5-290** 12.5 cm, 5"  
**F5-291** 14.5 cm, 5 1/2"  
 Curved serrated



**F5-292**  
 7.5 cm, 3"  
**F5-293**  
 9 cm, 3 1/2"  
**F5-294**  
 11 cm, 4"  
 Straight

**Feilichenfold Forceps**

**F5-295**  
 13.5 cm, 4"  
 Straight

**Hunter Forceps**

**F5-296**  
 10.5 cm, 4"  
 Curved

**Hunter Forceps**

**F5-297**  
 10.5 cm, 4"  
 Straight

**Carmalt Forceps**

**F5-298**  
 10.5 cm, 4"  
 Curved

**Carmalt Forceps**

**Splinter Forceps**

F5-299 8.0 cm, 3"  
 F5-300 9.0 cm, 3 1/2"  
 F5-301 10.8 cm, 4"  
 F5-302 11.8 cm, 4 1/2"  
 F5-303 12.8 cm 5"  
 F5-304 14.8 cm 5 1/2"  
 Straight serrated with  
 guide pin

**Splinter Forceps**

F5-305 8.0 cm, 3"  
 F5-306 9.0 cm, 3 1/2"  
 F5-307 10.8 cm, 4"  
 F5-308 11.8 cm, 4 1/2"  
 F5-309 12.8 cm 5"  
 F5-310 14.8 cm 5 1/2"  
 Curved serrated with  
 guide pin

**Splinter Forceps**

F5-311 8.0 cm, 3"  
 F5-312 9.0 cm, 3 1/2"  
 F5-313 10.8 cm, 4"  
 F5-314 11.8 cm, 4 1/2"  
 F5-315 12.8 cm 5"  
 F5-316 14.8 cm 5 1/2"  
 Straight plain with  
 guide pin

**Splinter Forceps**

F5-317 8.0 cm, 3"  
 F5-318 9.0 cm, 3 1/2"  
 F5-319 10.8 cm, 4"  
 F5-320 11.8 cm, 4 1/2"  
 F5-321 12.8 cm 5"  
 F5-322 14.8 cm 5 1/2"  
 Curved plain with  
 guide pin

**Stieglitz Forceps  
 with Magnifying  
 Mirrors**

F5-323  
 12.8 cm, 5"

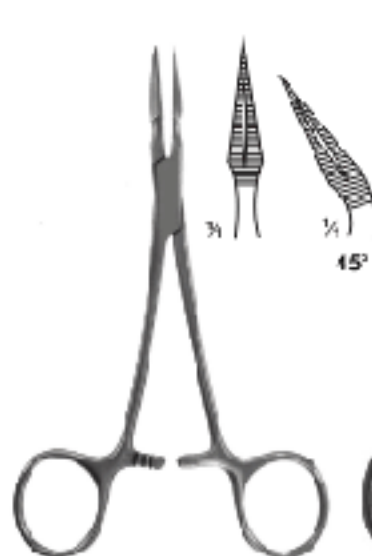
**Stieglitz Splinter Forceps**

F5-324 14 cm, 5 1/2" Str.  
 F5-325 14 cm, 5 1/2" 45° Angled

**Stieglitz Splinter Forceps**

F5-325  
 14 cm, 5 1/4" 90° Angled

**Peet Splinter Forceps**

F5-327  
 11.8 cm, 4 1/2"

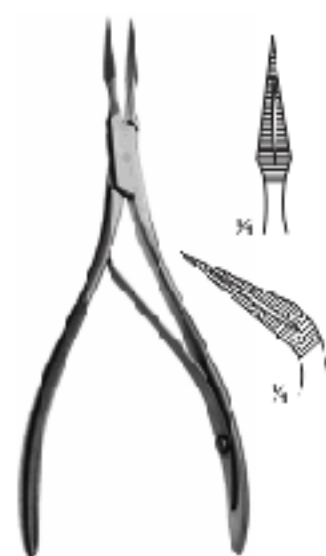
**Raik Splinter Forceps**

F5-328 16 cm, 6" Str.  
 F5-329 16 cm, 6" Cvd.





**Ochsner Forceps**  
**F5-330**  
 14 cm, 5 1/2"



**Lange Tissue Forceps**  
**F5-331**  
 10 cm, 4"



**Childe Tissue Forceps**  
**F5-332**  
 18 cm, 7"



**Michel Tissue Forceps**  
**F5-333**  
 12 cm, 4 3/4"



**Wachenfeldt Tissue Forceps**  
**F5-334**  
 12.5 cm, 5"



**HEGENBARTH Tissue Forceps**  
**F5-335**  
 12.5 cm, 5"



**Wachenfeldt Tissue Forceps**  
**F6-336**  
 12.5 cm, 5"



**Michel Forceps**  
**F6-337**  
 12 cm, 4 3/4"



**Michel Clips**  
**F5-338**  
 sizes: 11mm x 3mm  
 & 15mm x 3mm.



**Mod. Michel Forceps**  
**F6-339**  
 12 cm, 4 3/4"



**Collin Forceps**  
**F6-340**  
 13 cm, 5"



**Richter-Heath Forceps**  
**F6-341**  
 14 cm, 5 1/2"



# TISSUE & DRESSING FORCEPS T.C

Pincas a tissu, Anatomische pinzetten  
Gewebe, Fincas de disección

Pincas para tejidos, Pincas à dissection  
Pinze per tessuti, Pinze per dissezione

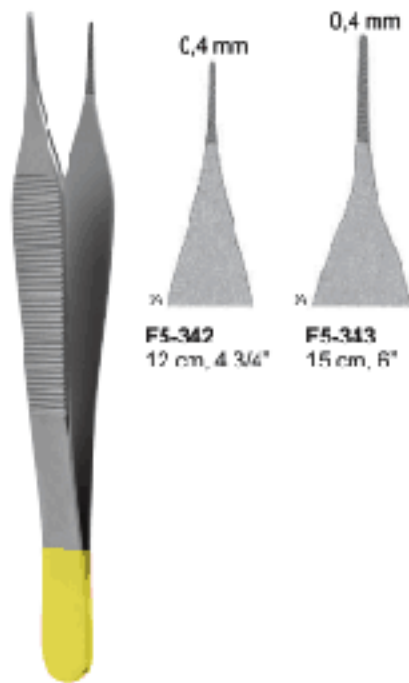

F5-342  
12 cm, 4 3/4"

F5-343  
15 cm, 6"

Micro Adson

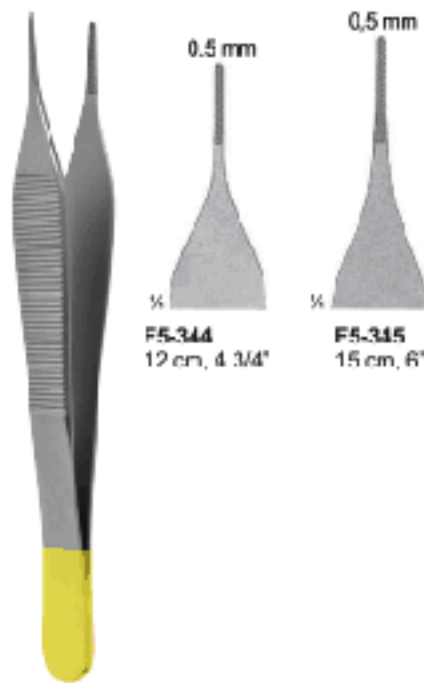

F5-344  
12 cm, 4 3/4"

F5-345  
15 cm, 6"

Adson



F5-346  
12 cm 4 3/4"

Adson



F5-347  
12 cm, 4 3/4"

F5-348  
15 cm, 6"

Micro Adson  
Light Weight



F5-349  
12 cm, 4 3/4"

F5-350  
15 cm, 6"

Adson  
Light Weight



F5-351  
12 cm, 4 3/4"

Adson  
Light Weight

*Pinces a tissu, Anatomische pinzetten*  
*Gewebe, Fincas de disección*

*Pinzas para tejidos, Pinces à dissection*  
*Pinze per tessuti, Pinze per dissezione*



**Micro Adson Tissue Forceps**  
 1x2 teeth

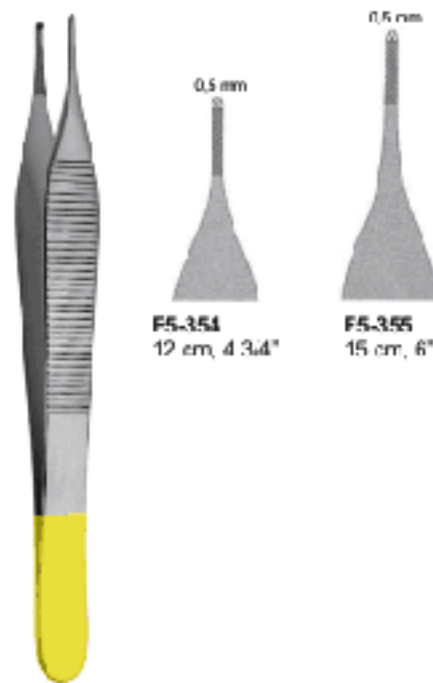

**Adson Tissue Forceps**  
 1x2 teeth



**Adson Tissue Forceps**  
 3x4 teeth



**Micro Adson Light Weight**  
 1x2 teeth



**Adson Light Weight**  
 1x2 teeth



**Adson-Brown Light Weight**  
 3x4 teeth

*Pinces a tissu, Anatomische pinzetten*  
*Gewebe, Pinzas de disección*

*Pinzas para tejidos, Pinces à dissection*  
*Pinze per tessuti, Pinse per dissezione*

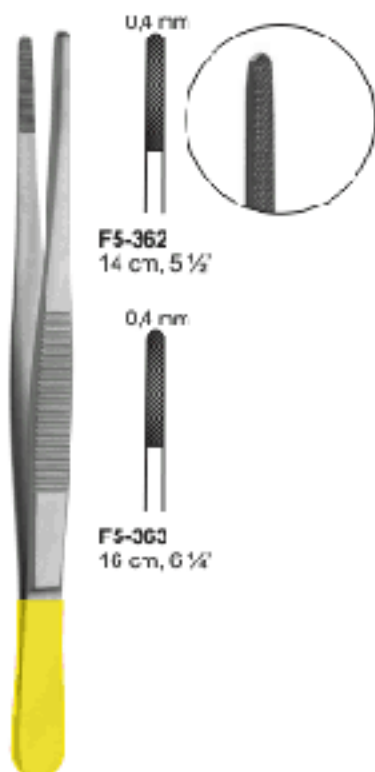

**T.C Standard Dressing Forceps**



**T.C Cushing Tissue Forceps**  
**F5-364 17.8 cm, 7"**



**T.C Cushing Dressing Forceps**  
**F5-365**  
**18 cm, 7" Cross Serrated**



**T.C Cushing Dressing Forceps**  
**F5-366 16 cm, 7"**



**T.C Dissecting Tissue Forceps**  
**F5-367 18 cm, 7"**



**T.C Resann Dressing Forceps**  
**F5-368**  
**25 cm, 10"**



**T.C Cushing Dressing Forceps**  
**F5-369**  
**19 cm, 7 1/2"**

*Pinces a tissu, Anatomische pinzetten*  
*Gewebe, Pinzas de disección*

*Pinzas para tejidos, Pincas à dissection*  
*Pinze per tessuti, Pinze per dissezione*



**Wangerstaen Dressing Forceps T.C.**

**T.C DeBakey Micro Needle Tissue Forceps F5-374**  
 16.4 cm, 7"

**T.C Bonney Dissecting & Tissue Forceps**



**T.C POTT8-EMTH Dressing Forceps**  
**F5-373** 15 cm, 6"  
**F5-379** 10 cm, 7"  
**F5-383** 20 cm, 8"  
**F5-301** 23 cm, 9"  
**F5-302** 25 cm, 10"

**T.C POTT8-EMTH Dressing Forceps**  
**F5-383** 16 cm, 6 1/2"  
**F5-384** 18 cm, 7"  
**F5-385** 21 cm, 8 1/2"  
**F5-386** 24 cm, 9 1/2"  
**F5-387** 26 cm, 10 1/2"

**T.C Evans Pelvic Needle Dressing Forceps F5-388**  
 25.4 cm, 10"

**T.C Evans Dressing Forceps F5-380**  
 25 cm, 10"

*Anatomische pinzetten*
*Pinces à dissection*
*Pinzas de disección*
*Pinze per dissezione*

0,4 mm



**T.C. Mc Indoe Dressing Forceps**  
**F5-390**  
 15.0 cm 6"



1,5 mm



2,0 mm



**T.C. De Bakley Dressing Forceps**  
**F5-391** 15.0 cm 6"  
**F5-392** 19.0 cm 7 1/2"  
**F5-393** 24.0 cm 9 1/2"



0,4 mm



**T.C. Gillies Tissue Forceps**  
**F5-394**  
 15.0 cm 6"



0,4 mm



**F5-395**  
 15 cm, 6"

**SEMKEN**  
 with dissector end



0,2 mm



**F5-396**  
 16 cm, 6 1/4"

0,2 mm



**F5-397**  
 18 cm, 7"

**SEMKEN**  
 1x2 teeth



1,5 mm

**F5-398**  
 14.0 cm 5 1/2"

3,0 mm

**F5-401**  
 20.0 cm 8"

2,0 mm

**F5-399**  
 16.0 cm 6 1/4"

3,7 mm

**F5-402**  
 25.0 cm 9 3/4"

2,7 mm

**F5-400**  
 18.0 cm 7"

4,0 mm

**F5-403**  
 30.0 cm 12"

**T.C. Dehler Tissue Forceps**



## HAEMOSTATIC FORCEPS

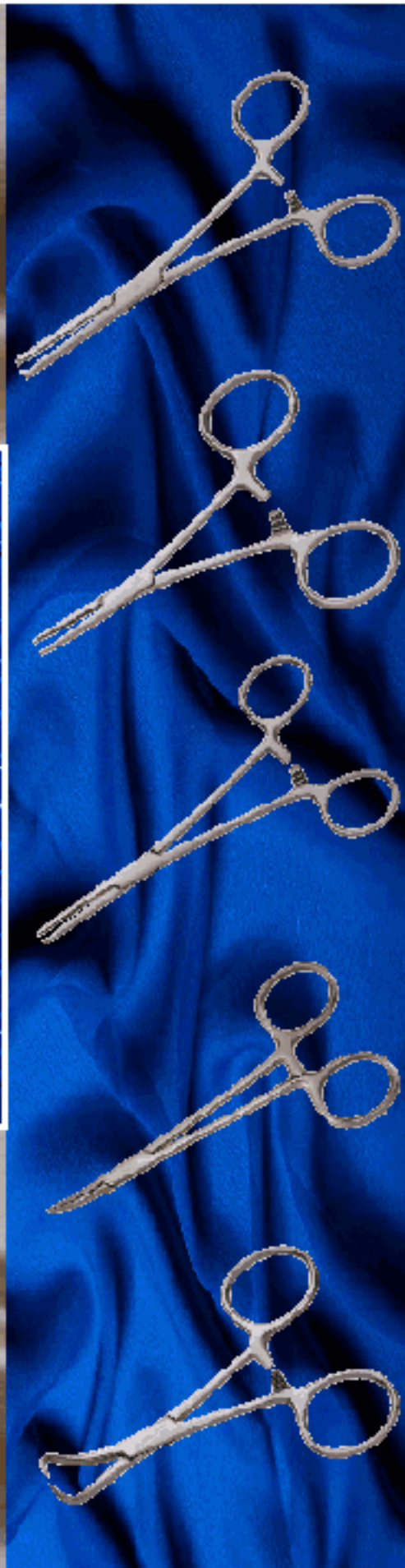
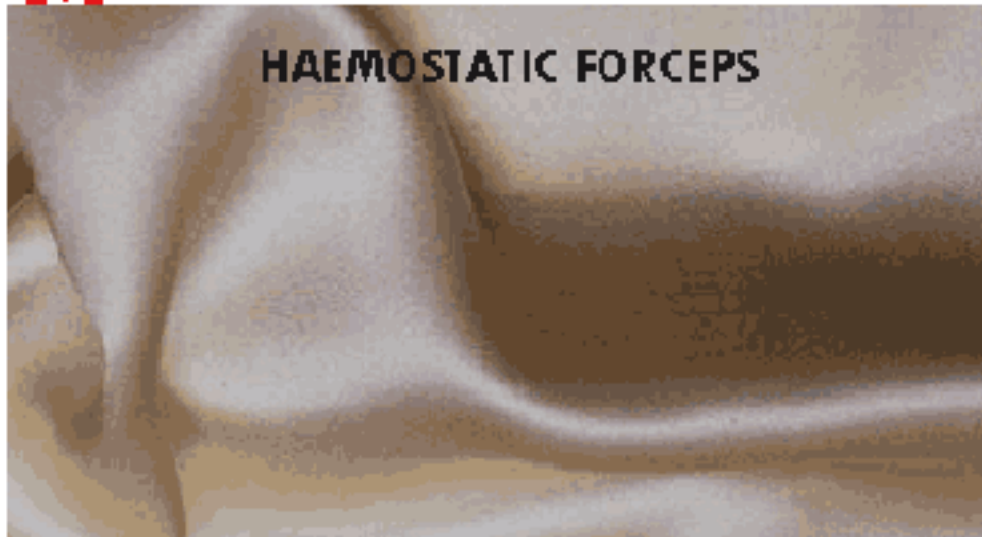

*Arterienklemmen*
*Pinces Hemostatiques*
*Pinces Hemostatiques*
*Pinze Emostatiche*

**F6-001**  
11.3 cm, 4 1/2"  
straight, serrated



**F6-002**  
11.3 cm, 4 1/2"  
curved, serrated



**F6-003**  
11.3 cm, 4 1/2" , straight  
Haemostatic tissue  
(rat tooth 1x2 teeth)



**F6-004**  
11.3 cm, 4 1/2" , curved  
Haemostatic tissue  
(rat tooth 1x2 teeth)

**Mosquito Haemostatic Forceps**

**F6-005** 12.5 cm, 5"  
**F6-006** 20 cm, 8"  
straight



**F6-007** 12.5 cm, 5"  
**F6-008** 20 cm, 8"  
curved

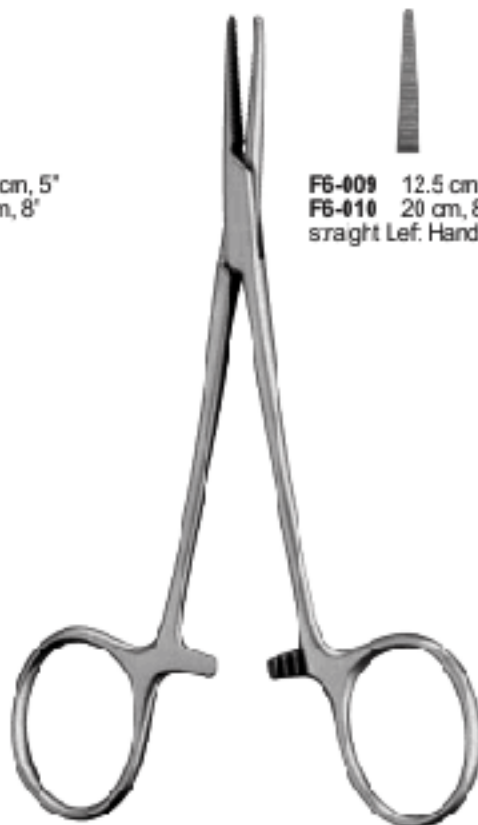

**F6-009** 12.5 cm, 5"  
**F6-010** 20 cm, 8"  
straight Left Handed



**F6-011** 12.5 cm, 5"  
**F6-012** 20 cm, 8"  
curved Left Handed

**Halsted Mosquito  
Haemostatic Forceps**
**Halsted Mosquito  
Haemostatic Forceps**





**Kelly Haemostatic Forceps**



**F6-013**  
14.0 cm, 5 1/2"  
straight



**F6-014**  
14.0 cm, 5 1/2"  
curved



**F6-015**  
Kelly Haemostatic Fine  
point Forceps 14.0 cm  
5 1/2", straight



**F6-016**  
Kelly Haemostatic Fine  
point Forceps 14.0 cm  
5 1/2", curved



**Dandy Haemostatic Forceps**  
**F6-017** 14.0 cm, 5 1/2"  
Curved sideways



**Dandy Haemostatic  
Fine point Forceps**  
**F6-018** 14.0 cm 5 1/2"  
Curved sideways



**Dandy Haemostatic  
Tissue Forceps**  
**F6-019** 14.0 cm 5 1/2"  
(rat tooth 1x2 teeth)  
Curved sideways



**Dandy Haemostatic Fine  
point Tissue Forceps**  
**F6-020** 14.0 cm, 5 1/2"  
(rat tooth 1x2 teeth)  
Curved sideways

Arterienklemmen  
 Pinces Hémostatiques

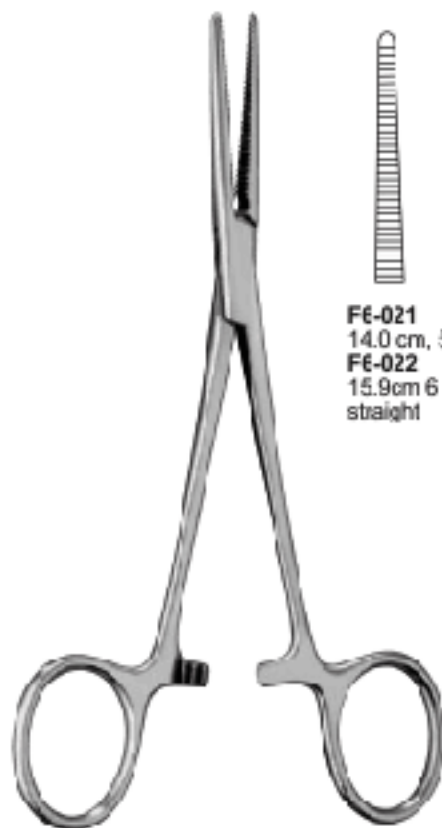
 Pinzas Hemostáticas  
 Pinze Emostatiche

**Crile Haemostatic Forceps**
**F6-021**  
 14.0 cm, 5 1/2"  
**F6-022**  
 15.9cm 6 1/4"  
 straight

**F6-023**  
 14.0 cm, 5 1/2"  
**F6-024**  
 15.9cm 6 1/4"  
 curved

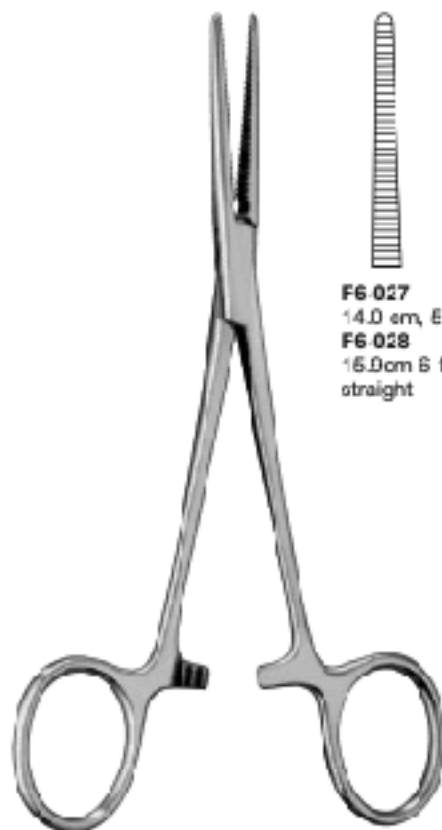
**Crile Haemostatic Tissue Forceps**
**F6-025**  
 14.0 cm, 5 1/2"  
 (rat tooth 1x2 teeth)  
 (KOCHER) straight

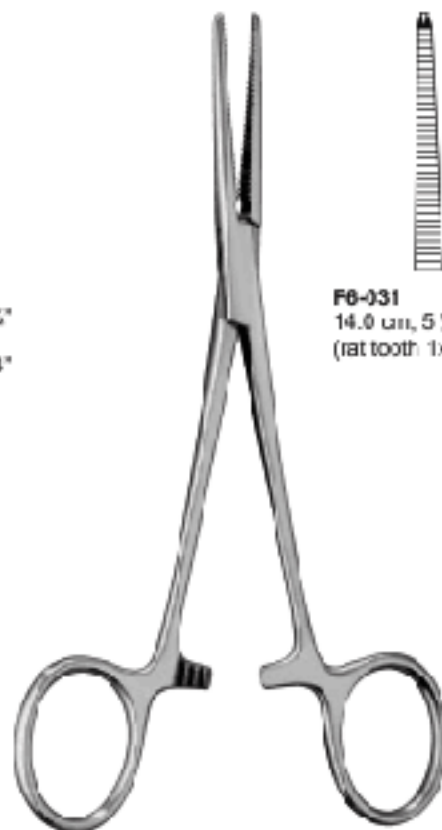
**F6-026**  
 14.0 cm, 5 1/2"  
 (rat tooth 1x2 teeth)  
 (KOCHER) curved

**Crile Haemostatic Fine Point Forceps**
**F6-027**  
 14.0 cm, 5 1/2"  
**F6-028**  
 16.0cm 6 1/4"  
 straight

**F6-029**  
 14.0 cm, 5 1/2"  
**F6-030**  
 16.0cm 6 1/4"  
 curved

**Crile Haemostatic Fine Point Tissue Forceps**
**F6-031**  
 14.0 cm, 5 1/2" straight  
 (rat tooth 1x2 teeth)

**F6-032**  
 14.0 cm, 5 1/2" curved  
 (rat tooth 1x2 teeth)

Arterienklemmen  
Pinces Hémostatiques

Pinzas Hemostáticas  
Pinze Emostatiche



**F6-033**  
18.5 cm, 7.25"  
straight



**F6-034**  
18.5 cm, 7.25"  
curved

**Halsted Haemostatic Forceps**

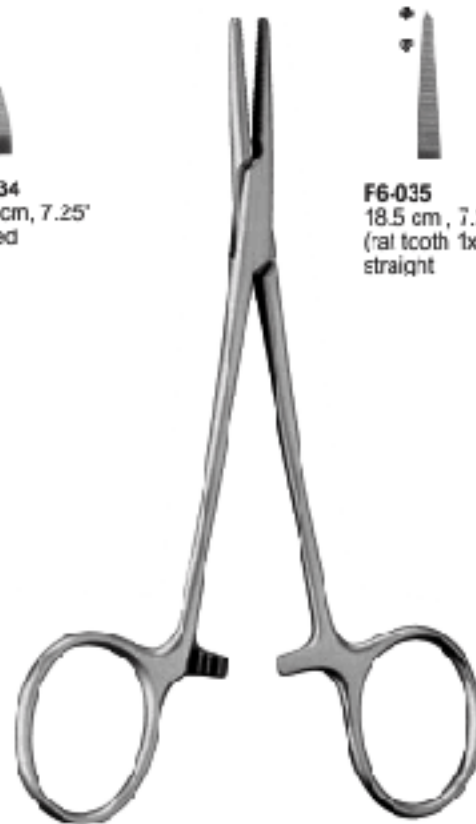

**F6-035**  
18.5 cm, 7.25"  
(rat tooth 1x2 teeth)  
straight



**F6-036**  
18.5 cm, 7.25"  
(rat tooth 1x2 teeth)  
curved

**Halsted Haemostatic Tissue Forceps**



**F6-037**  
18.5 cm, 7.25"  
straight



**F6-038**  
18.5 cm, 7.25"  
curved

**Halsted Haemostatic Fine point Forceps**

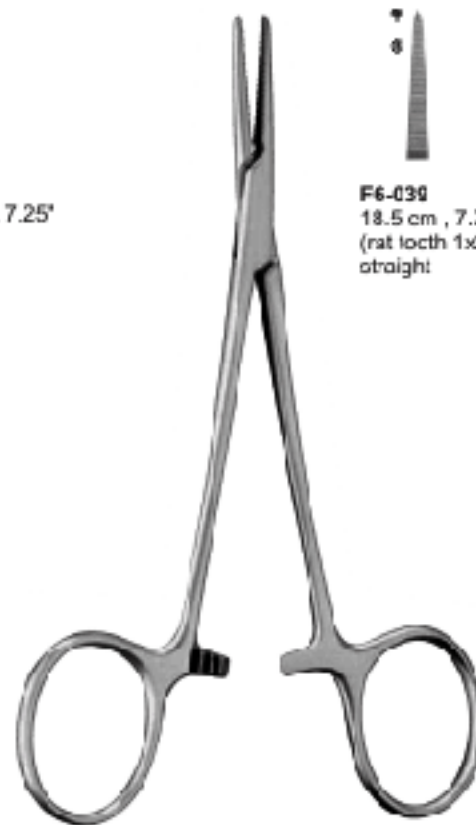

**F6-039**  
18.5 cm, 7.25"  
(rat tooth 1x2 teeth)  
straight



**F6-040**  
18.5 cm, 7.25"  
(rat tooth 1x2 teeth)  
curved

**Halsted Haemostatic Fine Point Tissue Forceps**

Arterienklemmen  
Pince Hemostatiques

Pinzas Hemostaticas  
Pinze Emostatiche



**Packer Mosquito Forceps**  
F6-041 5", 12.7cm  
curved, flat jaws



**Coller Haemostatic Forceps**



**F6-042** 14 cm, 5 1/2"  
**F6-043** 18 cm, 6 1/2"  
Straight, serrated

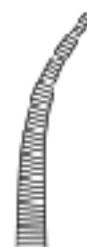

**F6-044** 14 cm, 5 1/2"  
**F6-045** 16 cm, 6 1/4"  
Curved, serrated



**Christophe Haemostatic Forceps**



**F6-046** 13.0 cm, 5"  
**F6-047** 15.0 cm, 6"  
Curved, Serrated



**Sargent Haemostatic Forceps**



**F6-048** 24 cm, 9 1/2"  
Straight, Serrated



**F6-049** 24 cm, 9 1/2"  
Curved Serrated

Arterienklemmen  
Pincès Hémostatiques

Pinzas Hemostaticas  
Pinze Emostatiche



**F6-050**  
18.5 cm, 7 1/2"  
straight

**F6-051**  
18.5 cm, 7 1/2"  
curved

**Adson Haemostatic Fine point Forceps**



**F6-052**  
18.5 cm, 7 1/2" straight:  
(rat tooth 1x2 teeth)

**F6-053**  
18.5 cm 7 1/2" Curved  
(rat tooth 1x2 teeth)

**Adson Haemostatic Tissue Forceps**



**F6-054** 15 cm, 6"  
**F6-055** 20 cm, 8"  
Curved

**F6-056** 15 cm, 6"  
**F6-057** 20 cm, 8"  
Curved Fine Point

**O'Shaughnessy Haemostatic Forceps**



**F6-058**  
14.5 cm, 5 3/4" Straight,  
box joint, as above but  
curved on flat.

**Cairns Haemostatic Forceps**

**Paan Haemostatic Forceps  
Slender Type**

**F6-059** 13.0 cm, 5"  
**F6-050** 14.0 cm, 5 1/2"  
 straight

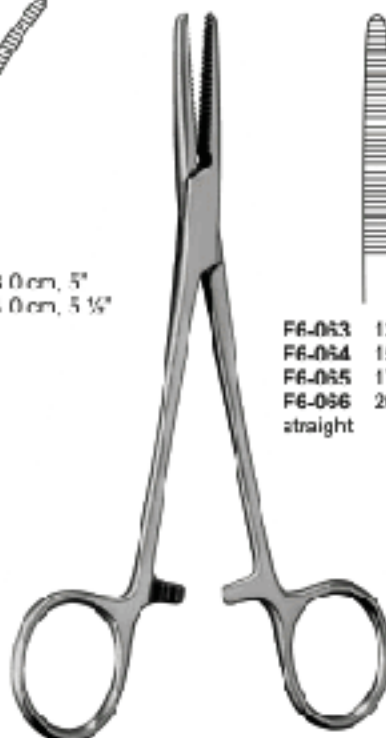

**F6-061** 13.0 cm, 5"  
**F6-062** 14.0 cm, 5 1/2"  
 curved

**Spencer-Wells Haemostatic Forceps  
Slender Type**

**F6-053** 13.0 cm, 5"  
**F6-054** 15.0 cm, 6"  
**F6-055** 17.5 cm, 7"  
**F6-056** 20 cm, 8"  
 straight

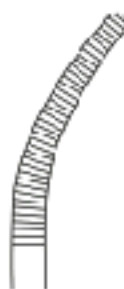

**F6-067** 13.0 cm, 5"  
**F6-068** 15.0 cm, 6"  
**F6-069** 17.5 cm, 7"  
**F6-070** 20 cm, 8"  
 curved

**Kocher Haemostatic  
Forceps Strong Pattern**

**F6-071**  
 14.5 cm, 5 3/4"  
 Straight

**Kocher Haemostatic Forceps  
1x2 teeth**

**F6-072** 13 cm, 5"  
**F6-073** 14 cm, 5 1/2"  
 straight



**F6-074** 13 cm, 5"  
**F6-075** 14 cm, 5 1/2"  
 curved





**F6-076**  
14 cm, 5.5"  
straight



**F6-077**  
16cm, 6 1/4"  
straight



**F6-073**  
18.5cm, 7 1/4"  
straight



**F6-079**  
20cm, 8"  
straight



**F6-080**  
22.5cm, 9"  
straight



**F6-081**  
24cm, 9 1/2"  
straight



**F6-082**  
25.4 cm, 10"  
straight



**F6-083**  
27.9 cm, 11"  
straight



**Rochester-Pean  
Haemostatic Forceps  
Straight**



**F6-084**  
30.5 cm,  
12"  
straight



**F6-085**  
35.6 cm,  
14"  
straight



**F6-086**  
40.64 cm,  
16"  
straight



**F6-087**  
45.72 cm,  
18"  
straight



**F6-088**  
50.8 cm,  
20"  
straight



**F6-089**  
55.88 cm,  
22"  
straight



**F6-090**  
60.96 cm,  
24"  
straight



Rochester-Pean  
Haemostatic Forceps  
Curved



**F6-081**  
14 cm, 5.5"  
Curved



**F6-092**  
16cm, 6 1/4"  
Curved



**F6-093**  
18.5cm, 7 1/4"  
Curved



**F6-094**  
20cm, 8"  
Curved



**F6-095**  
22.5cm, 9"  
Curved



**F6-096**  
24cm, 9 1/2"  
Curved

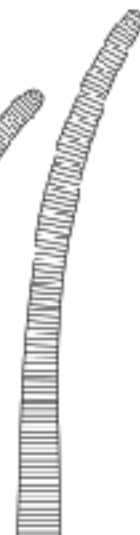

**F6-097**  
25.4 cm, 10"  
Curved

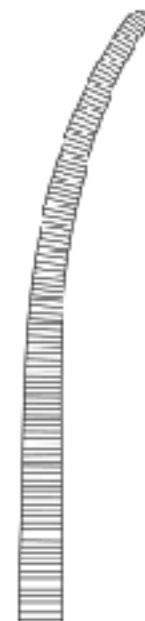

**F6-098**  
27.5 cm, 11"  
Curved



**F6-099**  
30.5 cm,  
12"  
Curved



**F6-100**  
35.6 cm,  
14"  
curved

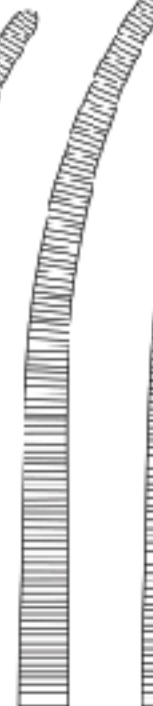

**F6-101**  
40.64 cm,  
16"  
curved

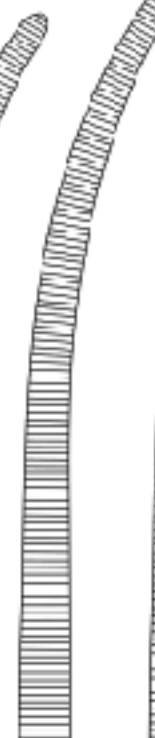

**F6-102**  
45.72 cm,  
18"  
curved

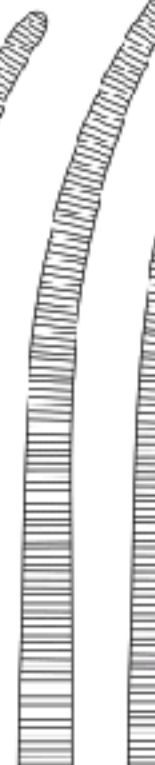

**F6-103**  
50.8 cm,  
20"  
curved

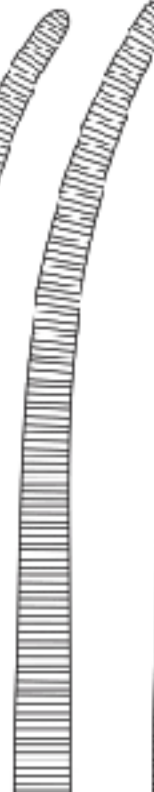

**F6-104**  
55.88 cm,  
22"  
curved

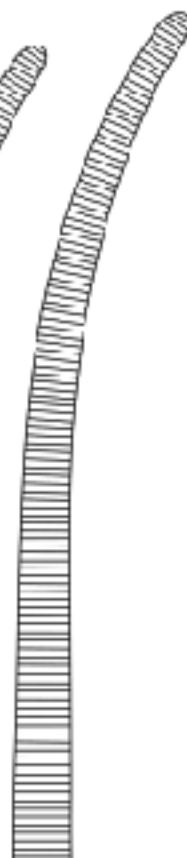

**F6-105**  
60.96 cm,  
24"  
curved



Arterienklemmen  
Pincas Hemostatiques

Pinzas Hemostaticas  
Pinze Emostatifiche



**Kocher-Ochsner  
Haemostatic Forceps**  
1x2 teeth



**F6-106**  
16cm, 6 1/4"  
straight  
1x2 teeth



**F6-107**  
18.5cm, 7 1/4"  
straight  
1x2 teeth



**F6-108**  
20cm, 8"  
straight  
1x2 teeth



**F6-109**  
22.5cm, 9"  
straight  
1x2 teeth



**F6-110**  
24.0cm, 9 1/2"  
straight  
1x2 teeth



**F6-111**  
26cm, 10 1/4"  
straight  
1x2 teeth



**F6-112**  
16cm, 6 1/4"  
Curved  
1x2 teeth



**F6-113**  
18.5cm, 7 1/4"  
Curved  
1x2 teeth



**F6-114**  
20cm, 8"  
Curved  
1x2 teeth



**F6-115**  
22.5cm, 9"  
Curved  
1x2 teeth

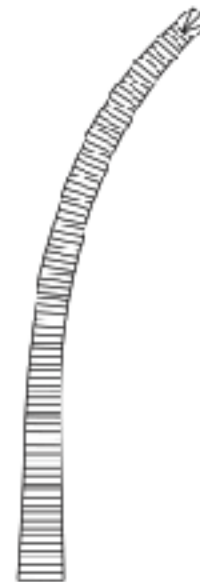

**F6-116**  
24.0cm, 9 1/2"  
Curved  
1x2 teeth



**F6-117**  
26cm, 10 1/4"  
Curved  
1x2 teeth

*Arterienklemmen*
*Pinzas Hemostaticas*
*Pinces Hemostatiques*
*Pinzas Emostatiche*

**F6-118**  
15.9cm, 6 1/4"  
**F6-119**  
20.3cm 8"  
Straight

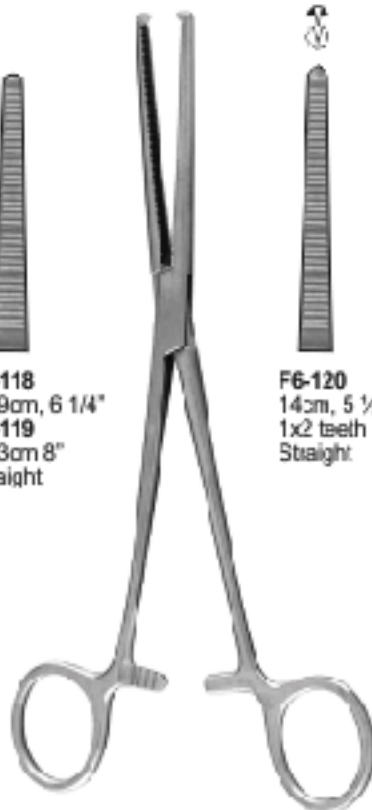

**Rochester-Ochsner  
Haemostatic Forceps**



**F6-120**  
14cm, 5 1/2"  
1x2 teeth  
Straight



**F6-121**  
14cm, 5 1/2"  
1x2 teeth  
Curved



**Rochester-Carmalt  
Haemostatic Forceps**



**F6-122**  
16 cm, 6 1/4"  
**F6-123**  
20 cm, 8"  
Straight



**F6-124**  
16 cm, 6 1/4"  
**F6-125**  
20 cm, 8"  
Curved

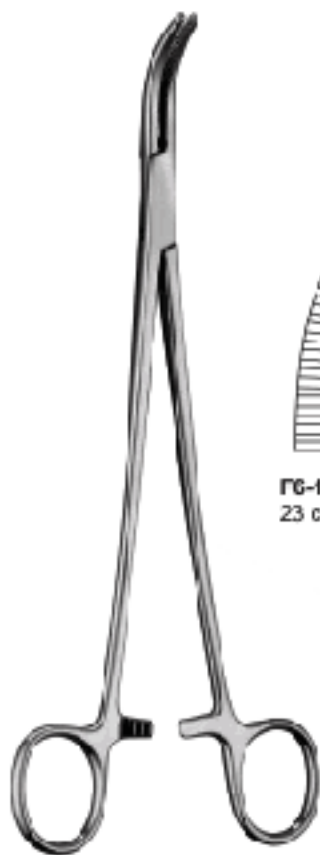

**Weynihan Haemostatic Forceps**

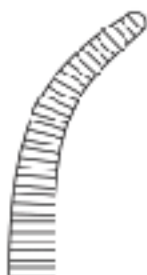

**F6-126**  
23 cm, 9"

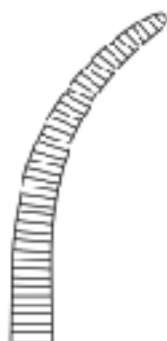

**F6-127**  
24 cm, 9 1/2"



**Negus Haemostatic Forceps**



**F6-128**  
18.5 cm, 7 3/8"



**F6-129**  
18.5 cm, 7 3/8"

Arterienklemmen  
Pincès Hémostatiques

Pinzas Hemostáticas  
Pinze Emostatiche

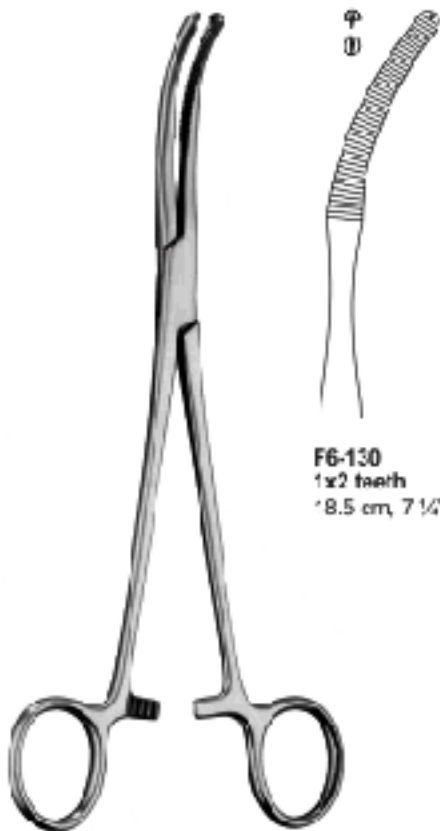

**F6-130**  
1x2 teeth  
18.5 cm, 7 1/4"

**Mikulicz Haemostatic Tissue Forceps**



**F6-131**  
Smooth  
21.5 cm, 8 1/2"

**F6-132**  
1x2 teeth  
21.5 cm, 8 1/2"

**Halsted Haemostatic Forceps**

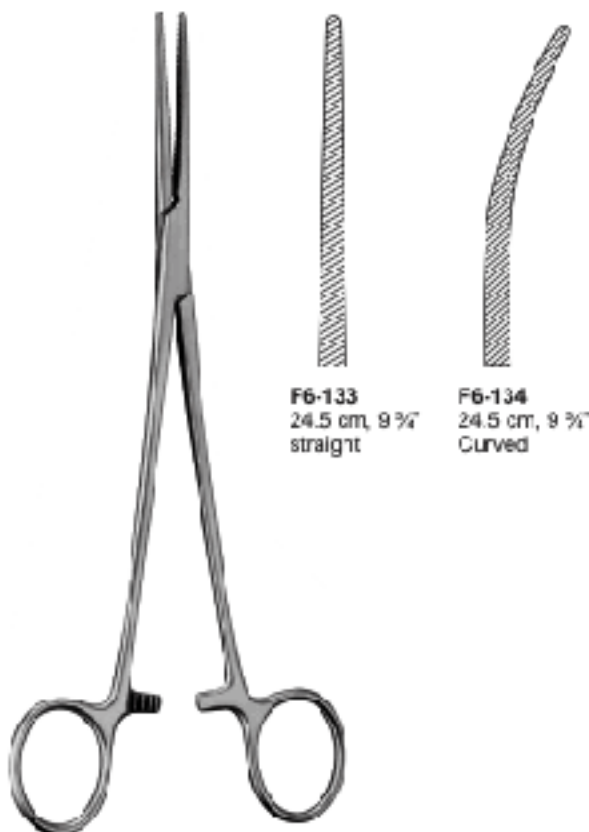

**F6-133**  
24.5 cm, 9 3/4"  
straight

**F6-134**  
24.5 cm, 9 3/4"  
Curved

**Bengolea Haemostatic Forceps**

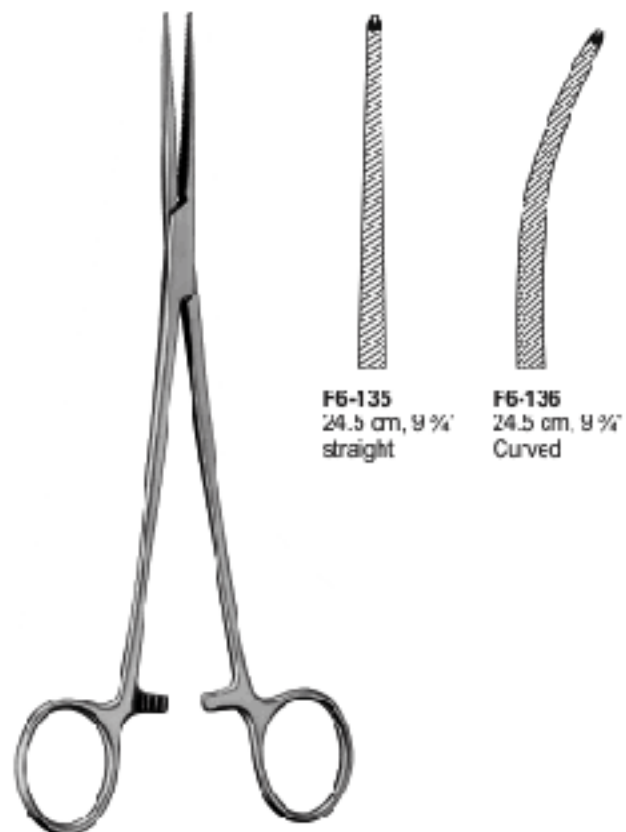

**F6-135**  
24.5 cm, 9 3/4"  
straight

**F6-136**  
24.5 cm, 9 3/4"  
Curved

**Bengolea Haemostatic Tissue Forceps**  
(rat tooth 1x2 teeth)

Arterienklemmen  
Pincès Hémostatiques

Pinzas Hemostáticas  
Pinze Emostatiche

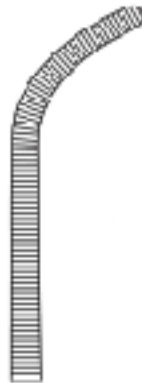

- F6-137** 14 cm, 5 1/2"
- F6-138** 16.5 cm, 6 1/2"
- F6-139** 19 cm, 7 1/2"
- F6-140** 21.5 cm, 8 1/2"
- F6-141** 24 cm, 9 1/2"

**Mixer-O'Shaugnessy  
Haemostatic Forceps**



- F6-142** 14 cm, 5 1/2"
- F6-143** 16.5 cm, 6 1/2"
- F6-144** 18 cm, 7 1/2"
- F6-145** 21.5 cm, 8 1/2"
- F6-146** 24 cm, 9 1/2"
- Fine Point

**Mixer-O'Shaugnessy  
Haemostatic Forceps**



- Mixer-O'Shaugnessy  
Haemostatic Forceps**
- F6-147** 14cm, 5 1/2"
  - F6-148** 16.5cm, 6 1/2"
  - F6-149** 19cm, 7 1/2"
  - F6-150** 21.5cm, 8 1/2"
  - F6-151** 24cm, 9 1/2"
  - micro point



- F6-152**  
24.5 cm, 9 3/4"

**Craford Haemostatic Forceps**

Arterienklemmen

Pinzas Hemostaticas

Pinces Hemostatiques

Pinze Emostatiche



**Herrick Haemostatic Forceps**  
F6-153 23.0 cm, 9"



**Roberts Haemostatic Forceps**

**F6-154**  
22.0 cm, 8 3/4"  
straight

**F6-155**  
22.0 cm, 8 3/4"  
Curved



**Crafoord-Sellers  
Haemostatic Forceps**

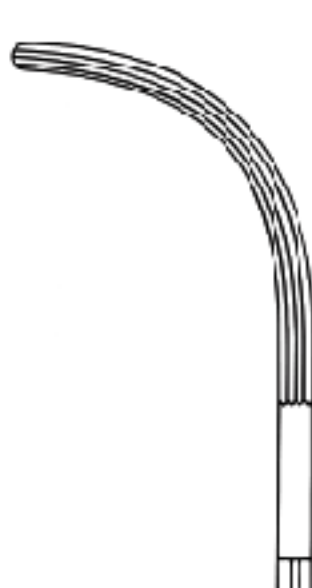

**F6-156**  
22.0 cm, 8 3/4"

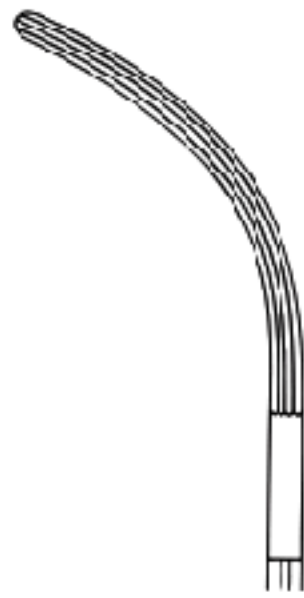

**F6-157**  
23.0 cm, 9"



**F6-158**  
24.0 cm, 9 1/2"

Arterienklemmen  
Pinces Hémostatiques

Pinzas Hemostaticas  
Pinze Emostatiche



**F6-159**  
20 cm, 8"  
Straight,  
Serrated



**F6-160**  
20 cm, 8"  
Slight Curve,  
Serrated



**F6-161** 21 cm, 8 1/4"  
Straight, Cross Serrated  
**F6-162** 21 cm, 8 1/4"  
Slight curved, Cross  
Serrated

Heaney / Ballantine  
Haemostatic Forceps

Heaney / Rezak  
Haemostatic Forceps

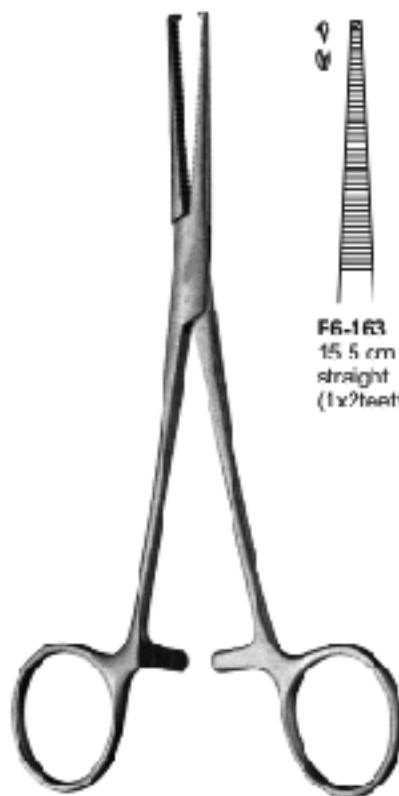

**F6-163**  
15.5 cm, 6"  
straight  
(1x2teeth)



**F6-164**  
15.5 cm, 6"  
Curved  
(1x2teeth)

Dixon-Lovelace  
Haemostatic Tissue Forceps

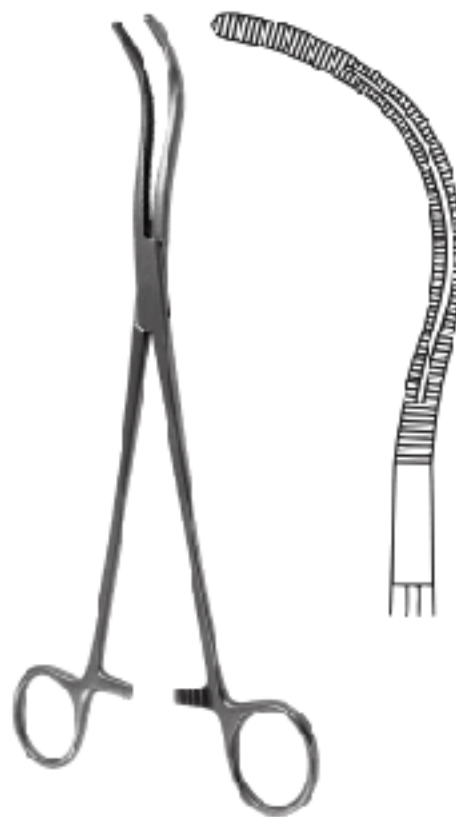

Stille Haemostatic Forceps  
**F6-165** 23 cm, 9"

Arterienklemmen  
Pincas Hemostatiques

Pinzas Hemostaticas  
Pinze Emostatiche

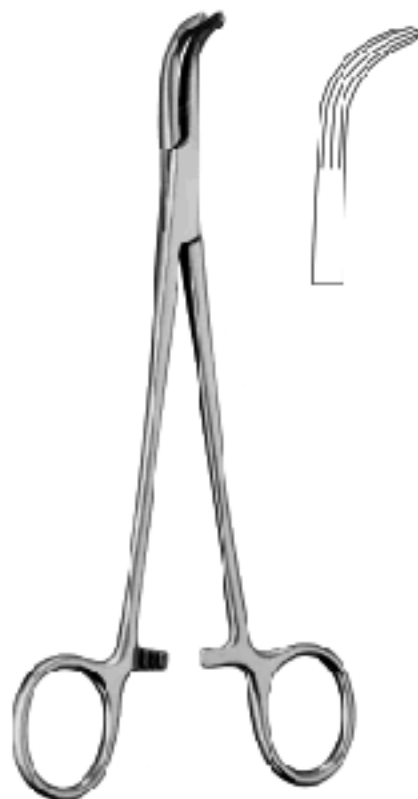

**Lower Haemostatic Forceps**  
F6-166 18cm, 7"

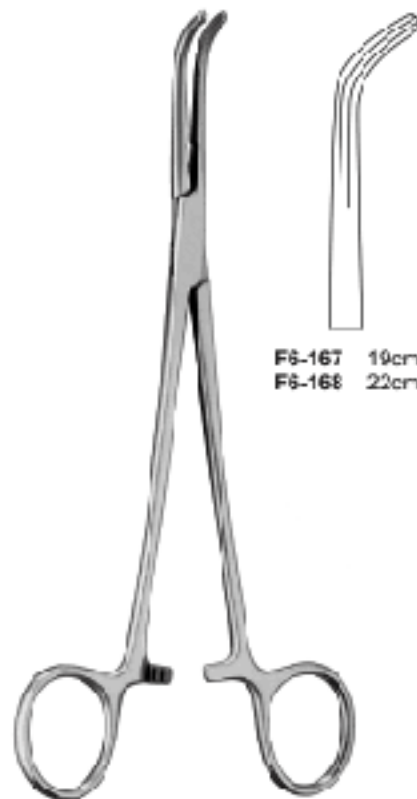

F6-167 19cm, 7 1/2"  
F6-168 22cm, 8 3/4"

**Lahey (Sweet)  
Haemostatic Forceps**



**Desjardins Haemostatic  
Forceps**  
F6-169 22cm, 8 3/4"

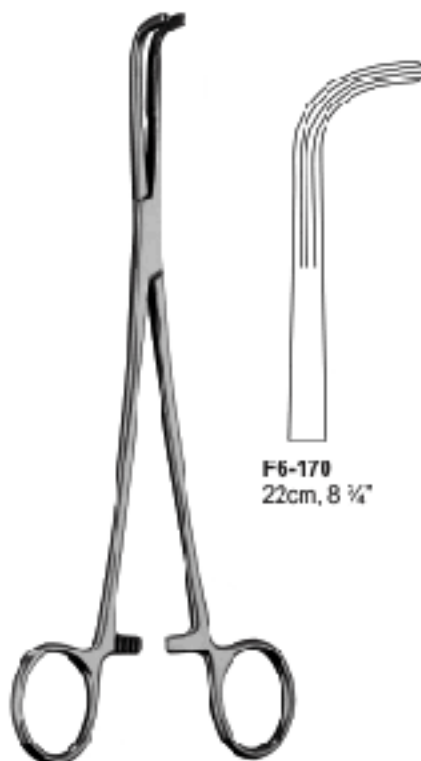

F6-170  
22cm, 8 1/4"

**Mixer Haemostatic  
Gall Duct Forceps**



F6-171  
25cm, 10"



F6-173  
**Mixer Forceps**, 18.4 cm  
7 1/4"  
Fully curved,  
original model

**Mixer Forceps, Lee Modif**  
F6-172 13.3 cm, 5.25"  
Curved jaws and angled  
shanks, delicate

*Arterienklemmen*
*Pinzas Hemostaticas*
*Pinces Hemostatiques*
*Pinze Emostatiche*

**Heaney Haemostatic Forceps**
**F6-174**

19.5 cm, 7 1/2"

**F6-175**

21.5 cm, 8 1/2"

**F6-176**

24 cm, 9 1/2"

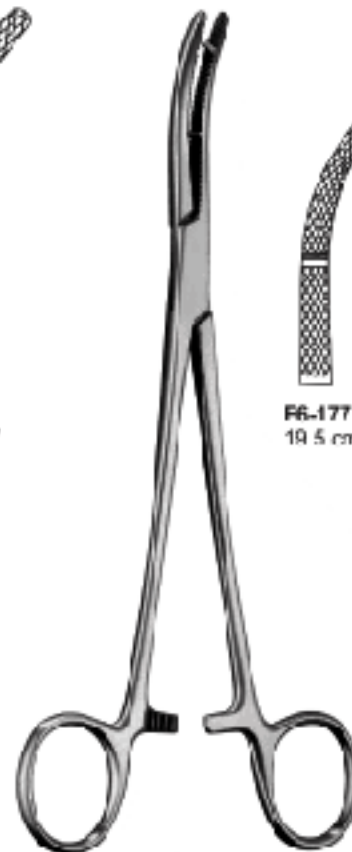
**Heaney Modif. Haemostatic Forceps**
**F6-177**

19.5 cm, 7 1/2"

**F6-178**

21.5 cm, 8 1/2"

**F6-179**

24 cm, 9 1/2"

**Heaney-Kanter Haemostatic Forceps**
**F6-100**

21 cm, 8 1/4"

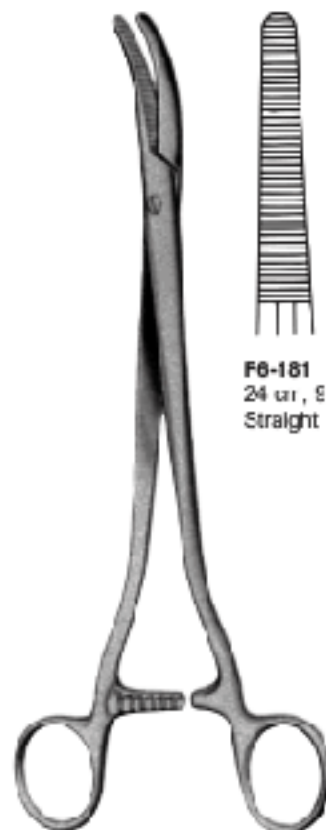
**Sogond London Haemostatic Forceps**
**F6-181**

 24 cm, 9 1/2"  
Straight

**F6-182**

 24 cm, 9 1/2"  
Curved

**Schindler Haemostatic Tissue Forceps**
**F6-183**  
1x2 teeth  
20 cm, 8"



Arterienklemmen  
Pincès Hémostatiques

Pinzas Hemostaticas  
Pinze Emostatiche



Parametrium Haemostatic Forceps



**F6-184**  
21 cm, 8 1/4"  
Straight



**F5-185**  
21 cm, 8 1/4"  
25° Angled



**F6-186**  
21 cm, 8 1/4"  
45° Angled



**F5-187**  
21 cm, 8 1/4"  
90° Angled



**F6-188**  
24 cm, 9 1/2"  
Straight



**F6-189**  
24 cm, 9 1/2"  
25° Angled



**F6-190**  
24 cm, 9 1/2"  
45° Angled



**F6-191**  
24 cm, 9 1/2"  
90° Angled



Bozemann Haemostatic Forceps

**F6-192**  
25 cm, 10 1/4"  
Curved, Serrated



Bozemann Haemostatic Forceps

**F6-193**  
26 cm, 10 1/4"  
Straight



Westermarck Haemostatic Forceps

**F6-194**  
23 cm, 9"  
Straight



Arterienklemmen  
Pinces Hémostatiques

Pinzas Hemostáticas  
Pinze Emostatiche



**F6-195**  
1x2 teeth  
21.5 cm, 8 1/2"  
Straight

**Phenef Haemostatic Tissue Forceps**

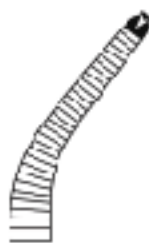

**F6-196**  
1x2 teeth  
21.5 cm, 8 1/2"  
Hard Curved



**F6-197**  
1x2 teeth  
19.0 cm, 7 1/2"  
Curved

**Long Haemostatic Tissue Forceps**



**F6-198**  
1x2 teeth  
19.0 cm, 7 1/2"  
Straight



**F6-199**  
1x2 teeth  
14 cm, 5 1/2"

**Baby Mikulicz Haemostatic Tissue Forceps**



**F6-200**  
1x2 teeth  
18.5cm 7 1/2"

**Mikulicz Haemostatic Tissue Forceps**





F6-201  
1x2 teeth  
20.5cm, 8"

Nikulicz Haemostatic Tissue Forceps



F6-202  
1x2 teeth  
20.5cm 8"

Nikulicz Haemostatic Tissue Forceps



F6-203  
1x2 teeth  
20.5cm, 8"

Nikulicz Haemostatic Tissue Forceps



F6-204  
1x2 teeth  
20.5cm 8"

Faure Haemostatic Tissue Forceps

Arterienklemmen  
 Pincès Hémostatiques

 Pinzas Hemostáticas  
 Pinze Emostatiche

**F6-205**  
 1x2 teeth  
 23.5cm, 9 1/4"

**Wertheim Haemostatic  
Tissue Forceps**

**F6-206**  
 1x2 teeth  
 24.5cm, 9 3/4"

**Wertheim Haemostatic  
Tissue Forceps**

**Heaney Atraumata  
Hysterectomy Forceps**

**F6-207**  
 22.5cm, 9"  
 Straight

**F6-208**  
 22.5cm, 9"  
 25° Angled

**F6-209**  
 21.5cm, 8 1/2"  
 45° Angled

**F6-210**  
 20.5cm, 8"  
 90° Angled

Arterienklemmen  
Pinces Hémostatiques

Pinzas Hemostaticas  
Pinze Emostatiche



Wertheim Parametrium Clamps



**F6-211**  
25cm, 10"  
Straight



**F5-212**  
24.5cm, 9 3/4"  
25° Angled



**F6-213**  
24cm, 9 1/2"  
45° Angled



**F6-214**  
22cm, 8 3/4"  
90° Angled



Wertheim Hysterectomy Forceps

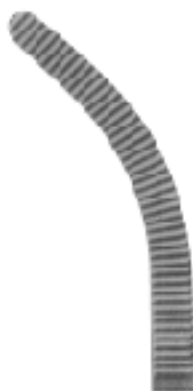

**F6-216**  
26.5cm, 10"



Wertheim Parametrium Clamp



**F6-215**  
26cm, 10 1/4"



**Gemini Mixer Hemostatic Forceps**  
F5-217 5 1/2"  
F5-218 7"  
full curve, delicate

Arterienklemmen  
Pinces Hémostatiques

Pinzas Hemostáticas  
Pinze Emostatiche



Dink Haemostatic Forceps



F6-219 26.5cm, 10"  
F6-220 26.5cm, 10 1/2"  
F6-221 27.5cm 10 3/4"



F6-222  
21.5cm 8 1/2"



Wertheim-Cullen  
Haemostatic Forceps



Wertheim-Cullen Haemostatic  
Forceps  
23cm, 9"

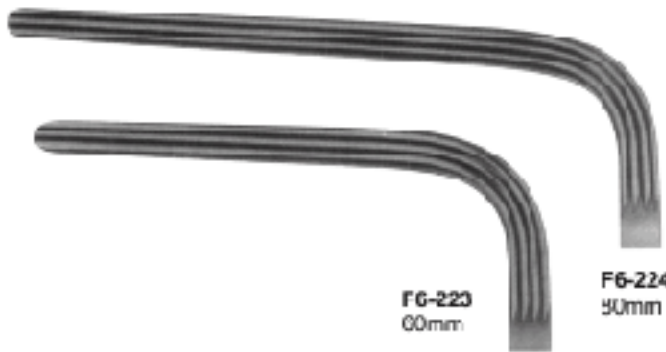

F6-223  
60mm  
F6-224  
50mm



F6-225  
25cm, 10"



Wertheim Haemostatic Forceps



**Jones / Perforating  
Towel Forceps**  
F6-226 9 cm, 3 1/4"  
Slight Curve



**Engl. Modell  
Towel Forceps**  
F6-227  
9 cm, 3 1/4"



**Schaecel Towel  
Forceps**  
F6-228  
9 cm 3 1/4"



**Thomson-Walker's  
Penile Clamps**  
F6-229 9 cm, 3 1/4"  
Cross-Action model



**Doyen Towel Forceps**  
F6-230 18 cm, 7"

**Backhaus Towel Forceps**

**F6-231** 8 cm, 3"  
**F6-232** 11 cm, 4 1/2"  
**F6-233** 13 cm, 5"  
**F6-234** 15 cm, 5 3/4"  
 Curved

**Backhaus Clip Towel Forceps**

**F6-235** 11 cm, 4 1/2"  
 with clip for tubing or cable

**Roder Towel Forceps**

**F6-236** 13 cm, 5"  
**F6-237** 15 cm, 6"  
 Curved, Serrated

**Loma Towel Forceps**

**F6-238** 9.0 cm, 3 1/2"  
**F6-239** 11.4 cm, 4 1/2"  
**F6-240** 13.5 cm, 5 1/4"

**Ball & Socket Towel Forceps**

**F6-241** 13 cm, 5"  
 Non-perforating

**Tohoku Towel Forceps**

**F6-242** 10cm, 4"  
**F6-243** 13cm, 5"  
 Non-Perforating





**Non-Perforating Towel Forceps**  
**F6-244** 11 cm, 4 1/2"  
**F6-245** 13 cm 5"



**Peers-Bertman Towel Forceps**  
**F6-246** 14.5 cm, 5 3/4"  
 Serrated



**Bernhard Towel Forceps**  
**FB-247**  
 13.5 cm, 6 1/4"



**Presbyterian Tubing Clamp**  
**F6-248** 16.5 cm, 6 1/2"  
**F6-249** 18 cm, 7"  
 Straight, Smooth



**Tubing Clamp**  
**F6-250** 18 cm, 7"  
**F6-251** 20 cm, 8"  
 Cross Serrated

Arterienklemmen  
Pincas Hemostatiques

Pinzas Hemostaticas  
Pinze Emostatiche



Tubing Clamp with Protector,  
Cross Serrated

F6-252  
15 cm, 6"

F6-253  
18 cm, 7"

F6-254  
20 cm, 8"



Klinikum Berlin Tubing Clamp

F6-256 14.5 cm, 6 3/4"  
with long satchet



Fergusson Tubing Clamp

F6-256  
15 cm 6 1/4"

F6-257  
20 cm, 8"



F6-258  
16 cm, 6 1/4"



F6-259  
20 cm, 8"

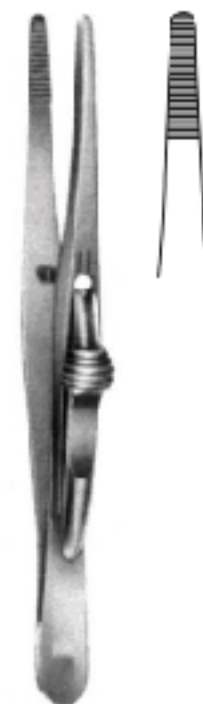

Fricke Artery Forceps  
F6-260 13cm, 5 1/4"

Arterienklemmen  
Pinces Hémostatiques

Pinzas Hemostáticas  
Pinze Emostatiche



**Tuffier Haemostatic Forceps**  
F6-261 13.0 cm, 5"



**Chaput Haemostatic Forceps**  
F6-262 13.0 cm, 5"



**Martel Haemostatic Forceps**  
F6-263 14.0 cm, 5 1/2"

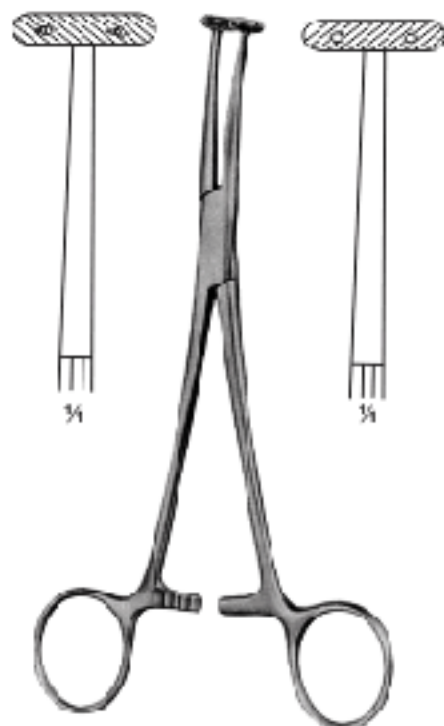

**Williet-Martel Haemostatic Forceps**  
F6-264 19.0 cm, 7 1/2"



**Pratt Haemostatic Forceps**  
F6-265 15 cm, 4 3/4"



**Pennington / Slesing Haemostatic Forceps**  
F6-266 15.5 cm, 6"  
F6-267 20 cm, 8"  
Straight

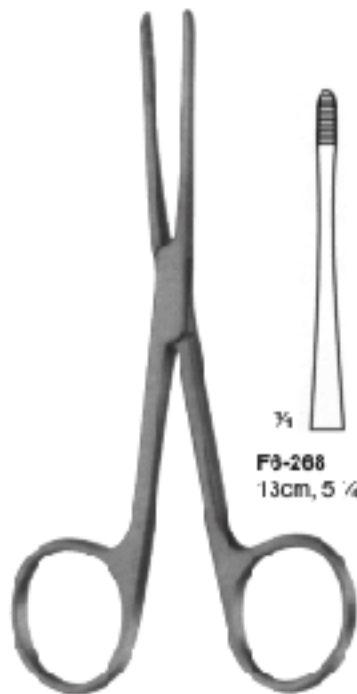

**F6-268**  
 13cm, 5 1/4"

**F6-269**  
 15.5cm, 6"

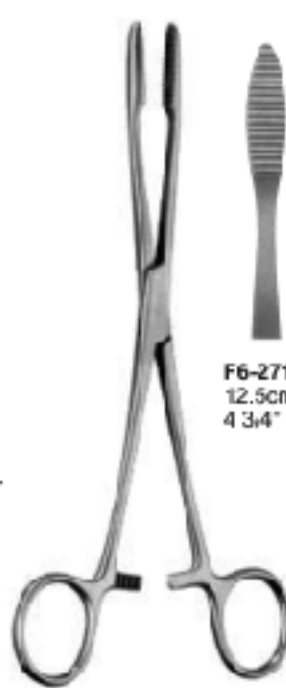
**F6-270**  
 17.5cm 7"

**Lister Sinus Forceps**

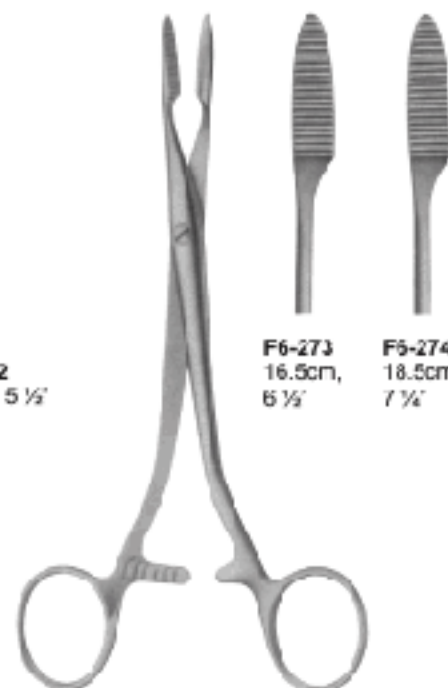
**F6-271**  
 12.5cm,  
 4 3/4"

**F6-272**  
 14cm, 5 1/2"

**Collin Dressing  
 Haemostatic Forceps**

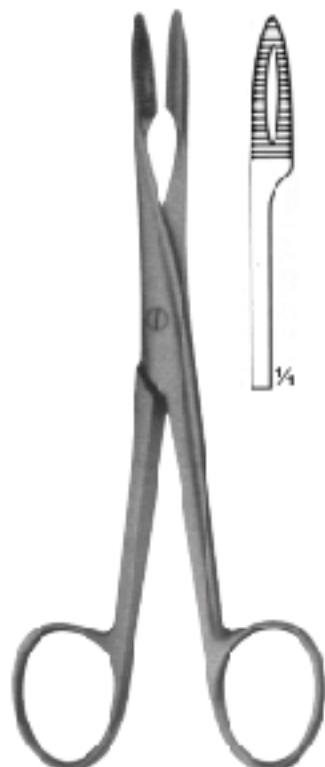
**F6-273**  
 16.5cm,  
 6 1/2"

**F6-274**  
 18.5cm,  
 7 1/4"

**Colling Dressing  
 Haemostatic Forceps**

**Gross Maier Dressing Forceps**  
**F6-275** 14.5cm, 5 3/4" straight  
 Without Ratchet

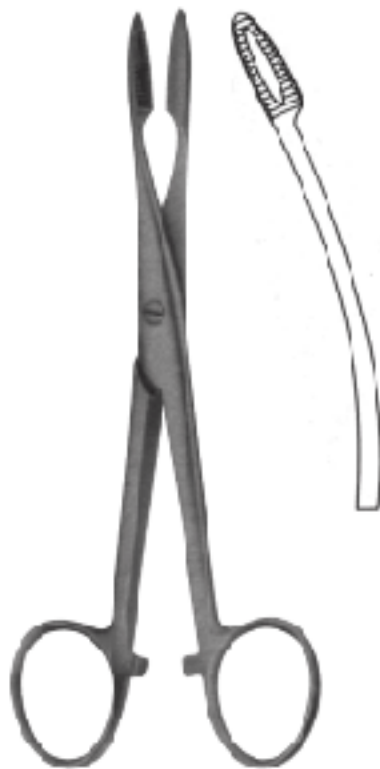
**Gross Maier Dressing Forceps**  
**F6-276** 14.5cm, 5 3/4" straight  
 With Ratchet

**Gross Maier Dressing Forceps**  
**F6-277** 14.5cm, 5 3/4" curved  
 With Ratchet

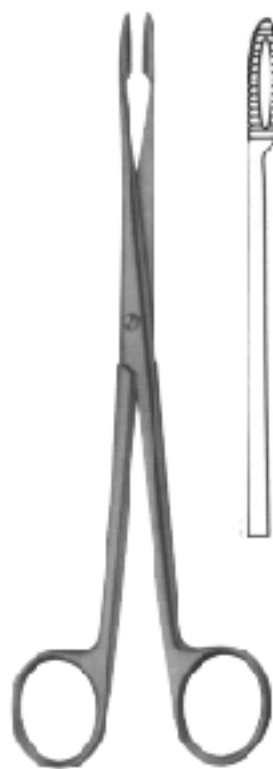

**Gross Maier Dressing Forceps**  
**F6-276** 14.5cm, 5 1/4" curved  
 With Ratchet



**Gross Maier Dressing  
 Sponge & Dressing Forceps**  
**F5-279** 20.5 cm, 8" straight  
 Without Ratchet



**Gross Maier Dressing  
 Sponge & Dressing Forceps**  
**F6-280** 17.8 cm, 7" straight  
 With Ratchet

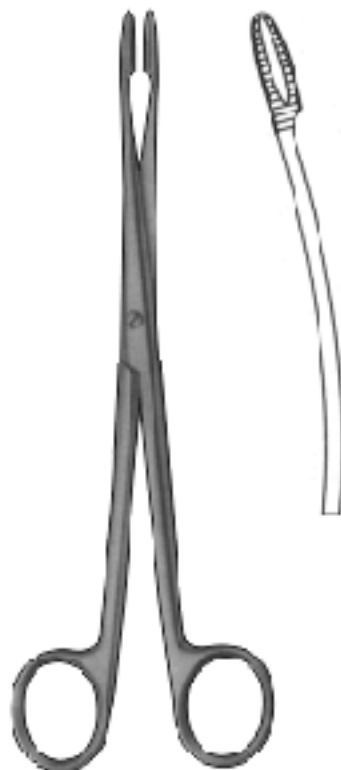

**Gross Maier Dressing  
 Sponge & Dressing Forceps**  
**F6-281** 21.5 cm, 8" curved  
 Without Ratchet  
 (bullet holding forceps)

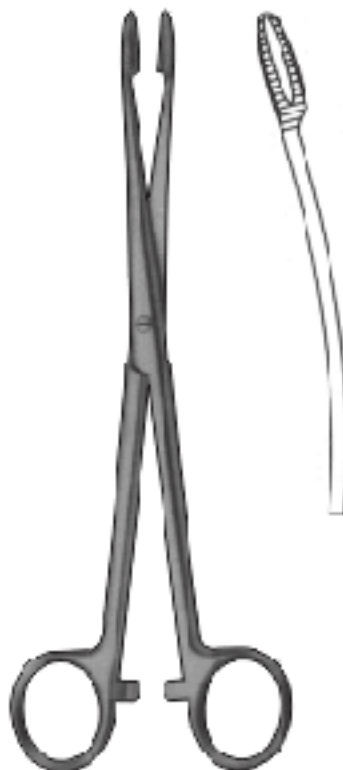

**Gross Maier Dressing  
 Sponge & Dressing Forceps**  
**F5-282** 17.8 cm, 7" curved  
 With Ratchet



**Gross Maier Dressing Forceps**  
**F6-283** 26.5cm, 10 1/2" straight  
 Without Ratchet  
 (bullet holding forceps)

Arterienklemmen  
Pincès Hémostatiques

Pinzas Hemostáticas  
Pinze Emostatiche



**Gross Maier Dressing Forceps**  
**F6-284** 26.5cm, 10 1/2" straight  
With Ratchet  
(bullet holding forceps)



**Gross Maier Dressing Forceps**  
**F5-285** 26.5cm, 10 1/2" curved  
Without Ratchet  
(bullet holding forceps)



**Gross Maier Dressing Forceps**  
**F5-286** 26.5cm, 10 1/2" curved  
With Ratchet  
(bullet holding forceps)

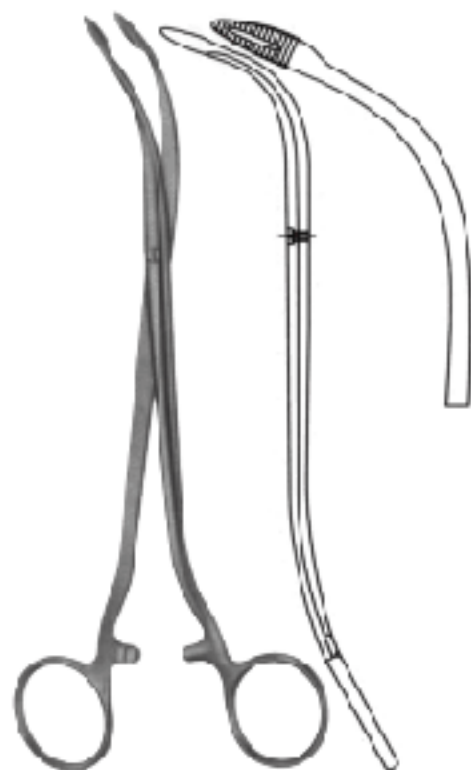

**Duplay Sponge & Dressing Forceps**  
**F6-217** 19cm, 7 1/2"  
Slight Curve

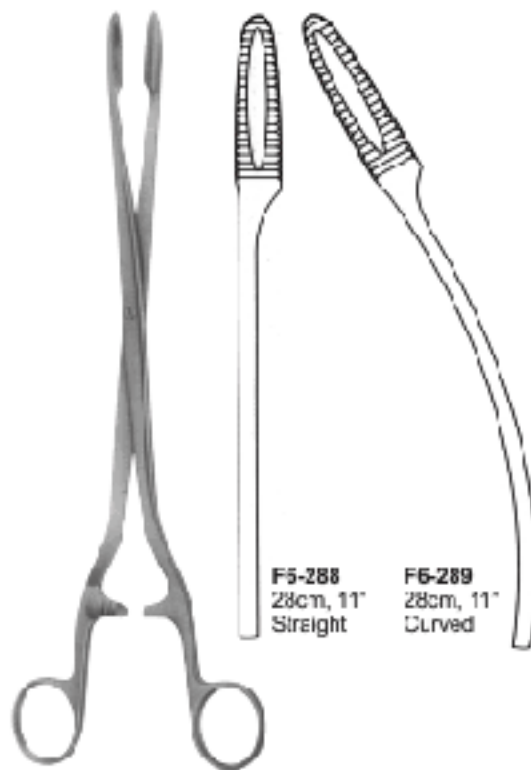

**F5-288**  
28cm, 11"  
Straight

**F6-289**  
28cm, 11"  
Curved

**Sims-Maier Sponge & Dressing Forceps**



**F6-290**  
24cm, 9 1/2"

**Collin Sponge & Dressing Forceps**

Arterienklemmen  
Pinces Hémostatiques

Pinzas Hemostáticas  
Pinze Emostatiche

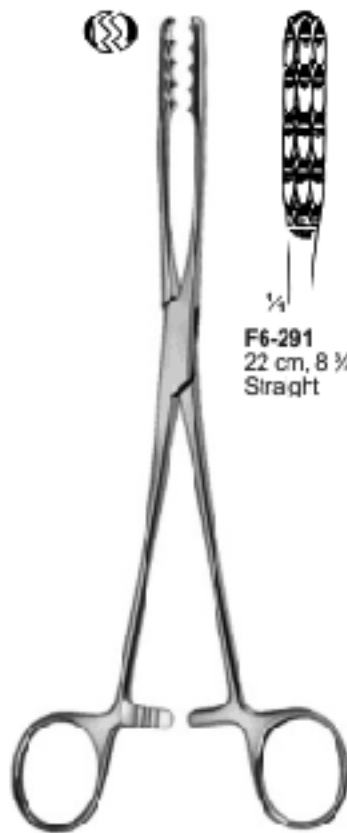

**F6-291**  
22 cm, 8 3/4"  
Straight

Ulrich Sponge Forceps

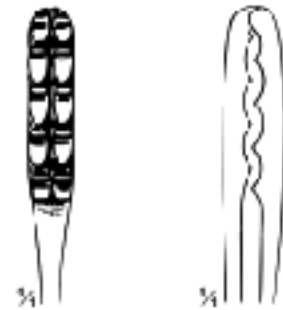

**F6-292**  
25 cm, 10"  
**F6-293**  
27 cm, 11"  
Straight



**F6-294**  
22 cm, 8 3/4"  
Curved

Ulrich Sponge Forceps



**F5-295**  
25 cm, 10"  
**F5-296**  
27 cm, 11"  
Curved



**F6-297**  
22cm, 9 1/2"  
Straight

Aesculap Sponge &  
Dressing Forceps



**F6-298**  
22cm, 9 1/2"  
Curved



**F6-299**  
24 cm, 9 1/2"  
Straight

Fletcher Sponge Forceps



**FG-300**  
24 cm, 9 1/2"  
Slight Curve

Fletcher Sponge Forceps

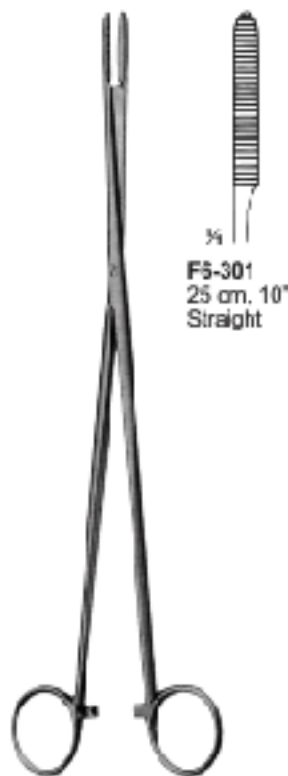

Arterienklemmen  
 Pinces Hémostatiques

 Pinzas Hemostáticas  
 Pinze Emostatiche

**F6-301**  
 25 cm, 10"  
 Straight

**Pellmann Sponge Forceps**

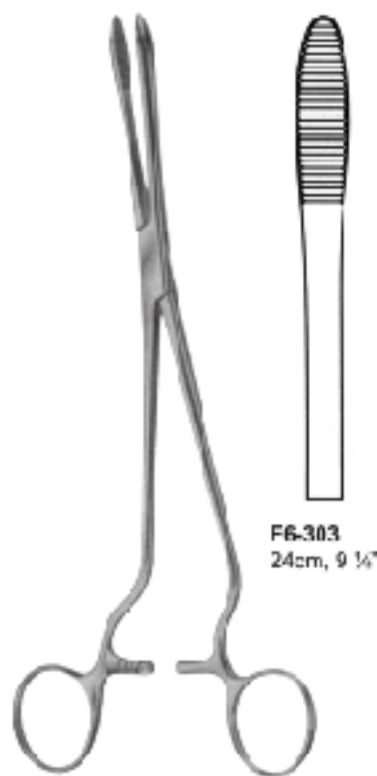
**F6-302**  
 25 cm, 10"  
 Curved

**Peckham Sponge Forceps**

**F6-303**  
 24cm, 9 1/2"

**Cheron Forceps**  
 Handles Laterally  
 Angled

**F6-304**  
 20.5 cm, 8"  
 Straight

**Duplay Sponge Forceps**

**F6-305**  
 20.5 cm, 8"  
 Curved

**Duplay Sponge Forceps**

**Heywood Smith**  
**Sponge Forceps**  
**F6-306** 25 cm, 10"

**F6-307**  
 21cm, 8 1/4"

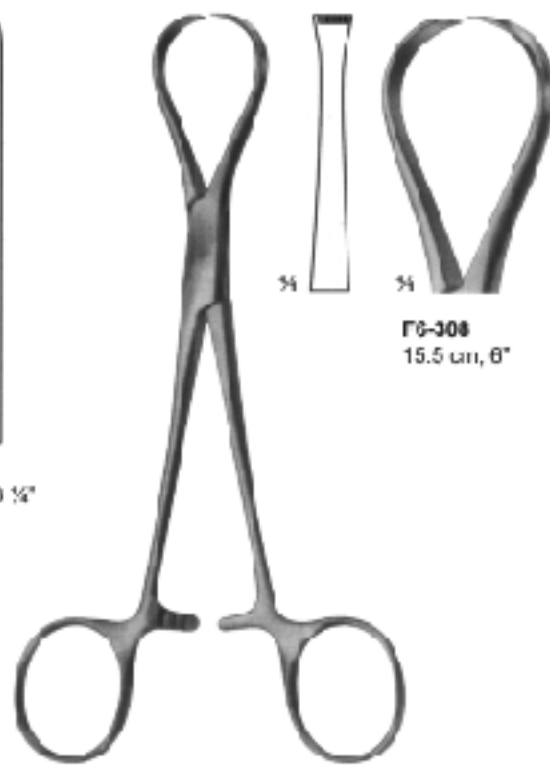
**Emmet Sponge &**  
**Dressing Forceps**

**F6-308**  
 15.5 cm, 6"

**Tendon Seizing Forceps**



Arterienklemmen  
Pinces Hémostatiques

Pinzas Hemostáticas  
Pinze Emostatiche



**Herz Tendon Seizing Forceps**



**F6-309**  
15.5 cm, 6"  
coarse serration



**F6-310**  
15.5 cm, 6"  
fine serrations

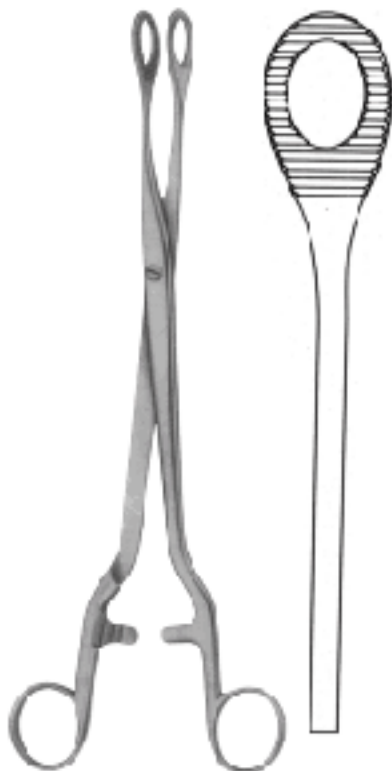

**Note Sponge &  
Dressing Forceps**  
F6-311 28cm, 11"



**Kelly Sponge &  
Dressing Forceps**



**F6-312**  
32cm, 12 1/2"  
Curved



**F6-313**  
32cm, 12 1/2"  
Straight

Arterienklemmen  
Pinces Hémostatiques

Pinzas Hemostáticas  
Pinze Emostatiche



**Foerster-Ballenger Sponge Forceps**  
& (bullet holding forceps)



**F6-314** 18cm, 7"  
**F6-315** 20.3cm, 8"  
**F6-316** 24.1cm, 9.5"  
Straight Smooth



**F6-317** 18cm, 7"  
**F6-318** 20.3cm, 8"  
**F6-319** 24.1cm, 9.5"  
Straight Serrated



**F6-320** 18cm, 7"  
**F6-321** 20.3cm, 8"  
**F6-322** 24.4cm, 9.5"  
Curved Smooth



**F6-323** 18cm, 7"  
**F6-324** 20.3cm, 8"  
**F6-325** 24.1cm, 9.5"  
Curved Serrated



**Collin Sponge & Dressing Forceps**



**F6-326**  
16cm, 6 1/4"



**F6-327**  
16cm, 6 1/4"



**F6-328**  
17cm, 6 3/4"



**Heywood Smith Sponge & Dressing Forceps**  
**F6-329** 20cm, 8"



## NEEDLE HOLDERS

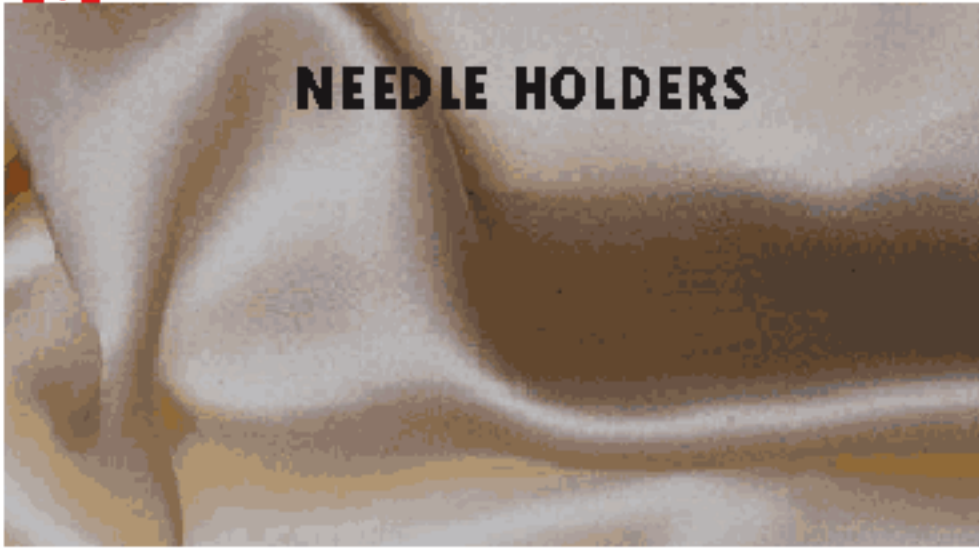



**Mayo-Hegar  
Needle Holders**

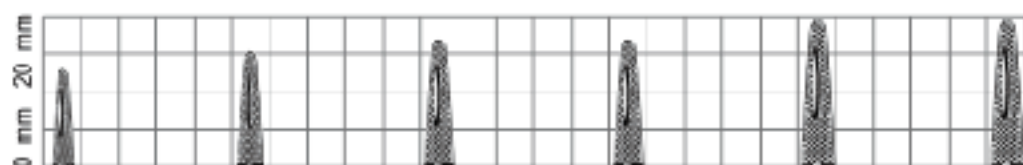

- |  |  |  |   |  |   |
|--|--|--|---|--|---|
| <b>F7-001</b><br>12.7 cm, 5"<br>Serrated-<br>Grooved | <b>F7-002</b><br>14 cm, 5 1/2"<br>Serrated-<br>Grooved | <b>F7-003</b><br>15.2 cm, 6"<br>Serrated-<br>Grooved | <b>F7-004</b><br>15.2 cm, 6"<br>Serrated-<br>Grooved<br>left handed | <b>F7-005</b><br>17.8 cm, 6 3/4"<br>Serrated-<br>Grooved | <b>F7-006</b><br>17.8 cm, 6 3/4"<br>Serrated-<br>Grooved<br>left handed |
|--|--|--|---|--|---|

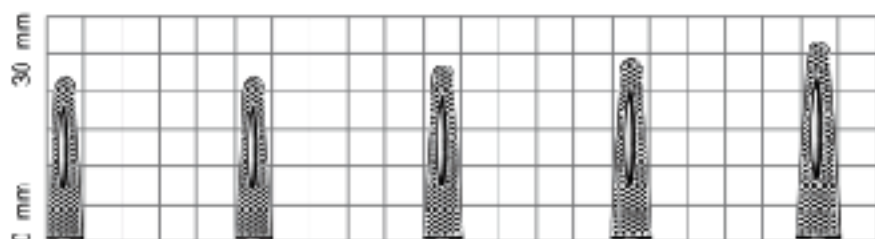

- |  |   |  |   |   |
|--|---|--|---|---|
| <b>F7-007</b><br>20.3 cm, 8"<br>Serrated-<br>Grooved | <b>F7-008</b><br>20.3 cm, 8"<br>Serrated-<br>Grooved<br>left handed | <b>F7-009</b><br>24.8 cm, 9 3/4"<br>Serrated-<br>Grooved | <b>F7-010</b><br>26 cm, 10 1/4"<br>Serrated-<br>Grooved | <b>F7-011</b><br>30.5 cm, 12"<br>Serrated-<br>Grooved |
|--|---|--|---|---|



- |  |  |  |  |
|--|--|--|--|
| <b>F7-012</b><br>12.7 cm, 5"<br>Serrated-<br>Grooved<br>Curved | <b>F7-013</b><br>14 cm, 5 1/2"<br>Serrated-<br>Grooved<br>Curved | <b>F7-014</b><br>15.2 cm, 6 1/4"<br>Serrated-<br>Grooved<br>Curved | <b>F7-015</b><br>17.8 cm, 7"<br>Serrated-<br>Grooved<br>Curved |
|--|--|--|--|

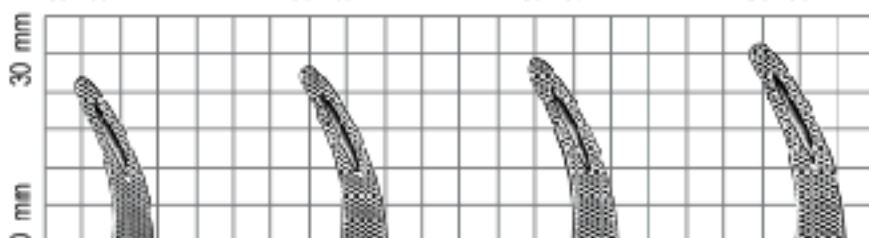

- |  |  |   |   |
|--|--|---|---|
| <b>F7-016</b><br>20.3 cm, 8"<br>Serrated-<br>Grooved<br>Curved | <b>F7-017</b><br>24.8 cm, 9 3/4"<br>Serrated-<br>Grooved<br>Curved | <b>F7-018</b><br>26 cm, 10 1/4"<br>Serrated-<br>Grooved<br>Curved | <b>F7-019</b><br>30.5 cm, 12"<br>Serrated-<br>Grooved<br>Curved |
|--|--|---|---|

**BAUMGARTNER**  
 Needle Holder

**F7-020**  
 12.7 cm, 5"  
 Serrated-Solid

**F7-021**  
 14 cm, 5 1/2"  
 Serrated-Solid

**F7-022**  
 16 cm, 6 1/4"  
 Serrated-Solid

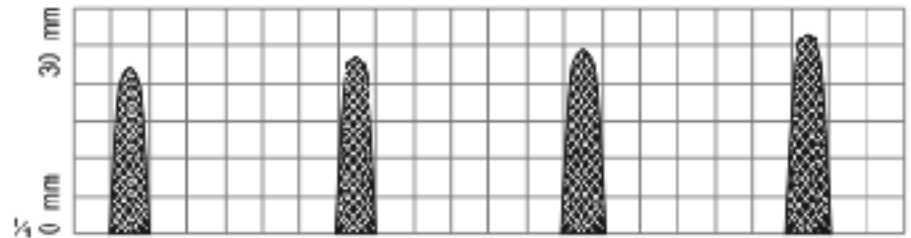
**F7-023**  
 17.8 cm, 7"  
 Serrated-Solid

**F7-024**  
 20.3 cm, 8"  
 Serrated-Solid

**F7-025**  
 24.8 cm, 9 3/4"  
 Serrated-Solid

**F7-026**  
 26 cm, 10 1/4"  
 Serrated-Solid

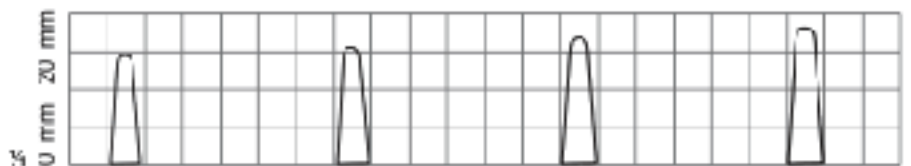
**F7-027**  
 30.5 cm, 12"  
 Serrated-Solid

**WERSTER**  
 Needle Holder

**F7-028**  
 11.4 cm, 4 1/2"  
 Smooth

**F7-029**  
 12 cm, 4 3/4"  
 Smooth

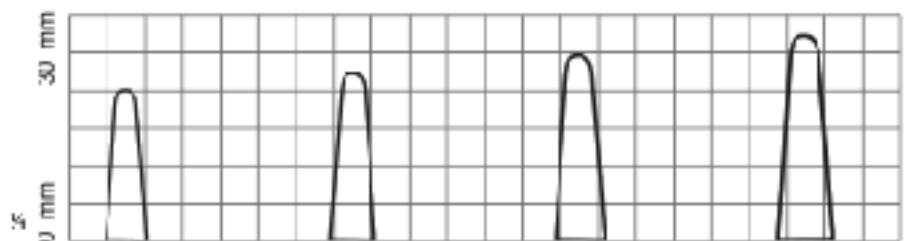
**F7-030**  
 12.7 cm, 5"  
 Smooth

**F7-031**  
 13.3 cm, 5 1/4"  
 Smooth

**F7-002**  
 14 cm, 5 1/2"  
 Smooth

**F7-033**  
 15.2 cm, 6"  
 Smooth

**F7-034**  
 17.0 cm, 7"  
 Smooth

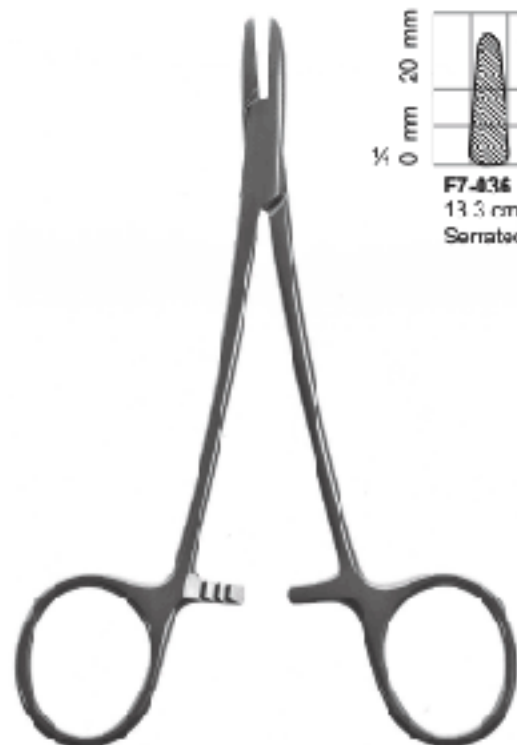
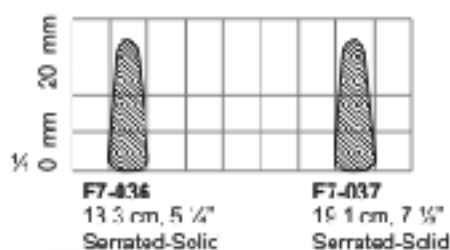
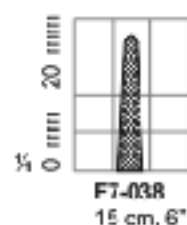
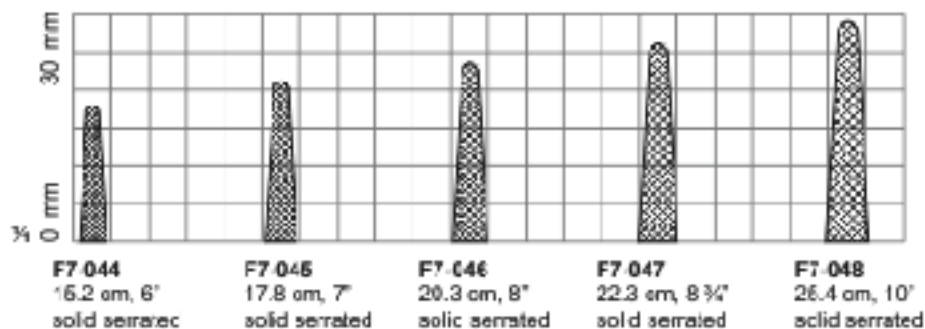
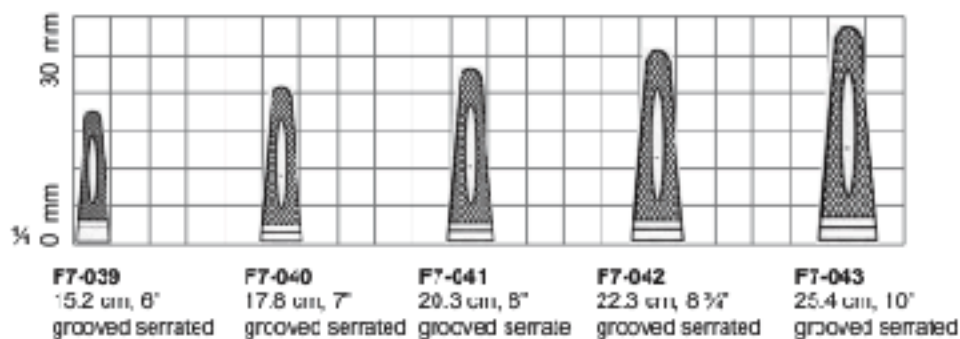
**F7-005**  
 20.3 cm, 8"  
 Smooth

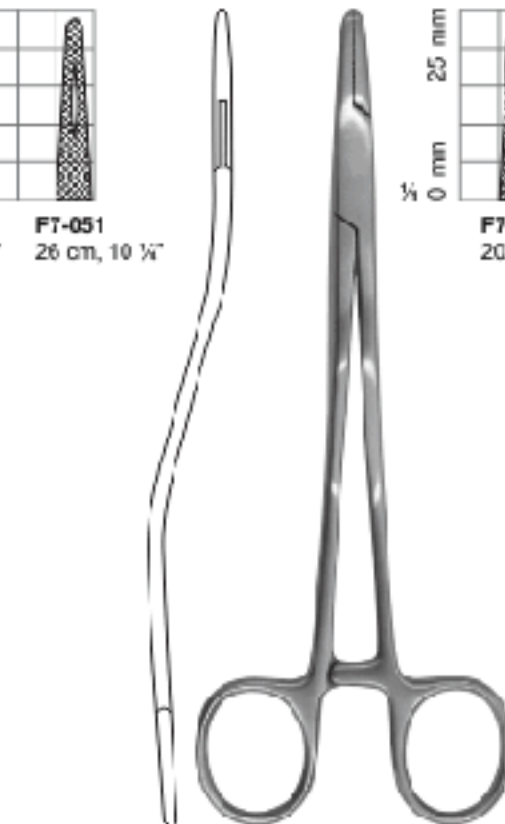
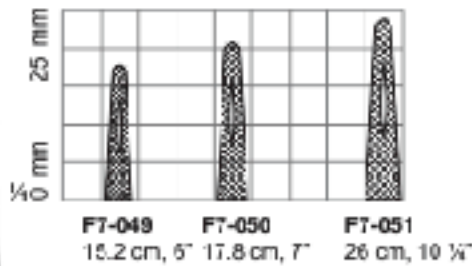
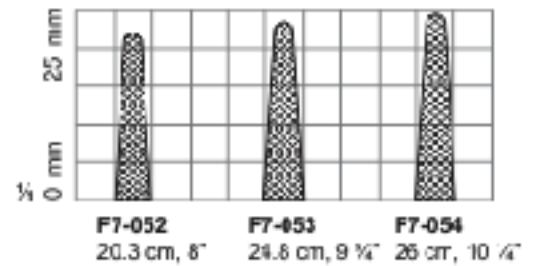
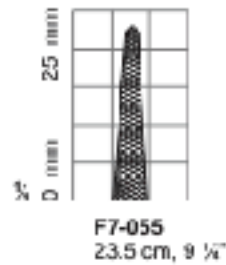
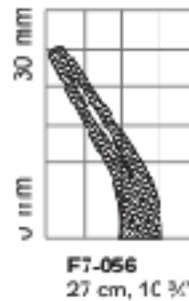
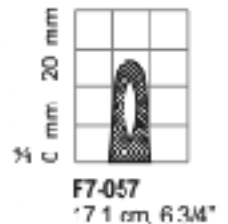
**BROWN**  
 Needle Holder

**BABY CRILE-WOOD**  
 Needle Holder

**CRILE-WOOD**  
 Needle Holder

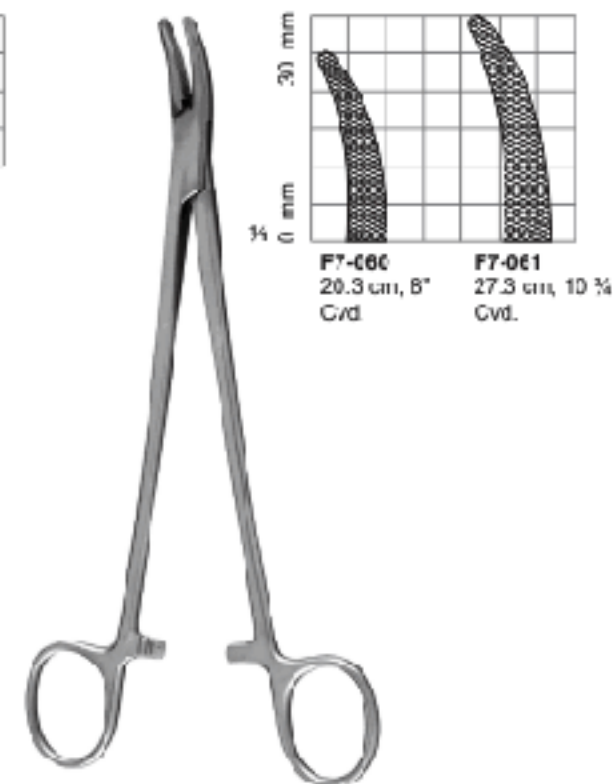
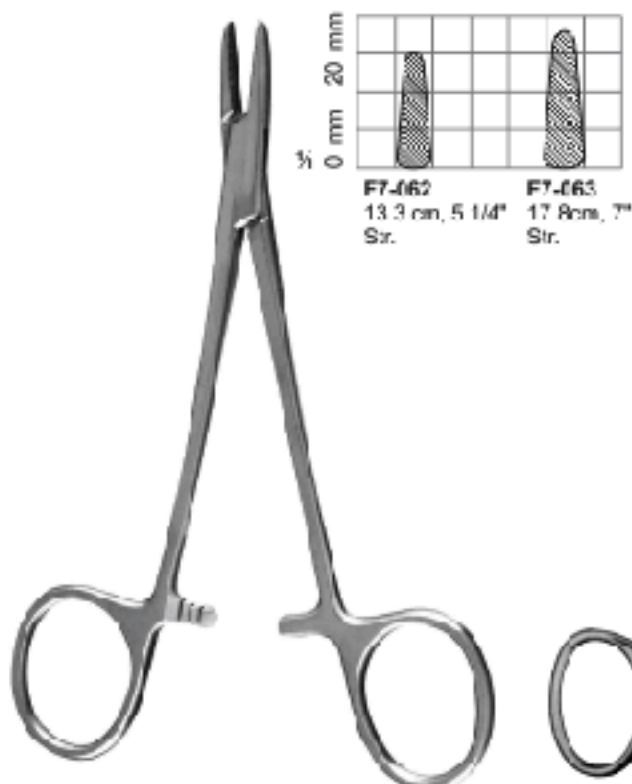
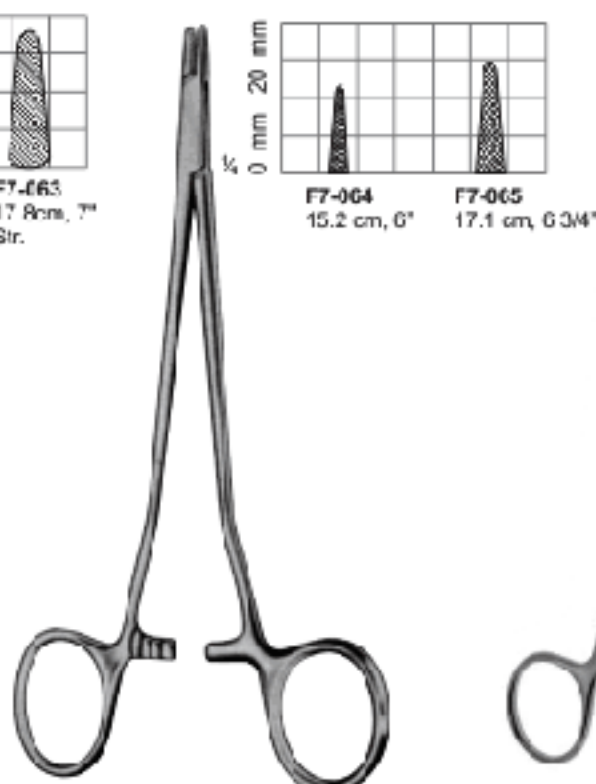
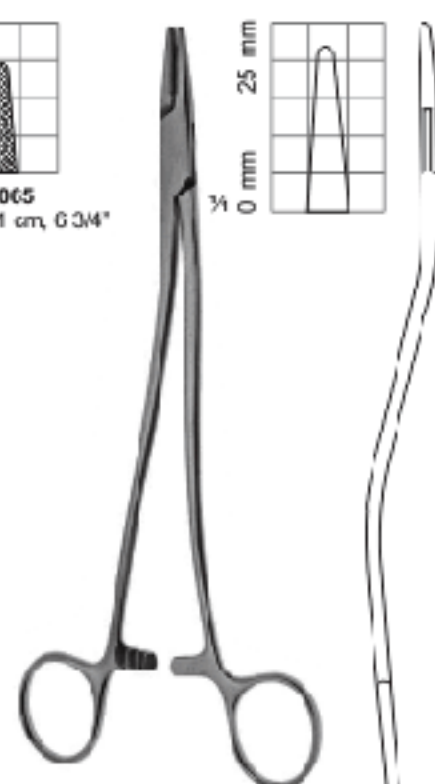

**Sarot Needle Holders**

**Bczemann Needle Holders**
**F7-040**

**Jameson Needle Holders**

**Finocchietto Needle Holders**

**Mass. General Hospital  
Needle Holders**

*Nedelhalter* | *Porta-agujas*  
*Prote-aiguilles* | *Porta aghi*

**Adson Needle Holders**

**New Orleans Needle Holders**

**Heaney Needle Holders  
07-165**

**Brown Needle Holders**

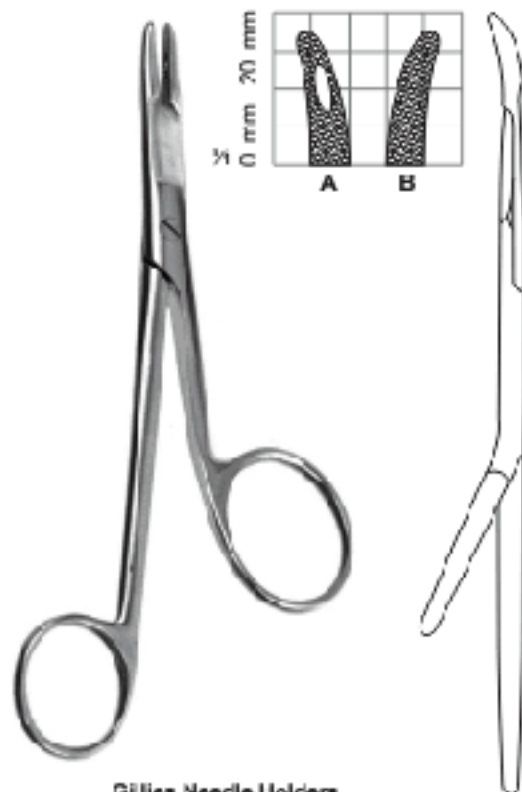
**Sensring Needle Holders  
(Schwed. Model)**

**Wertheim Needle Holders  
F7-066 20 cm 8"  
F7-067 24 cm 9 1/2"**

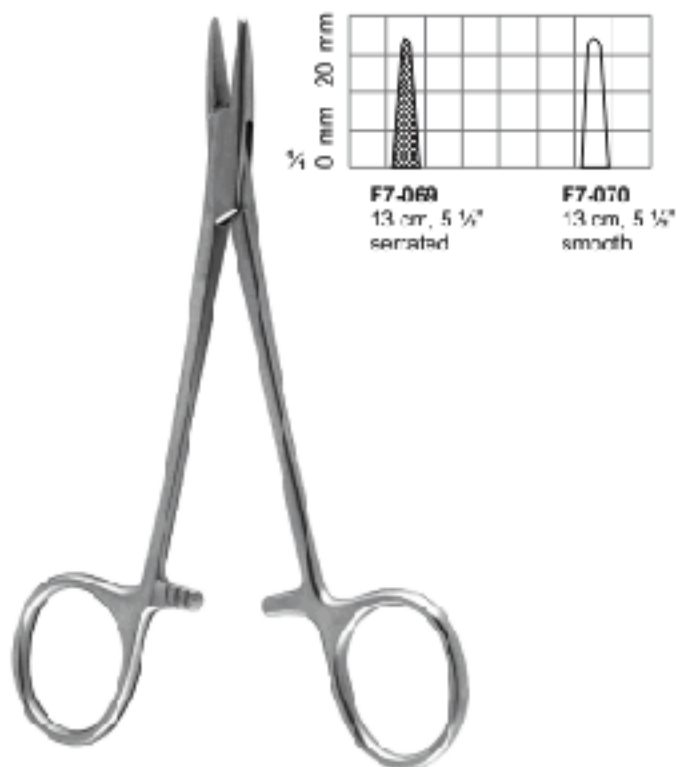

Nedelhafter | Porta-agujas  
 Prote-agulhas | Porta aghi



**Gillies Needle Holders**  
**F7-060**  
 16 cm, 6 1/4"



**Halsey Needle Holders**

**F7-069**  
 13 cm, 5 1/8"  
 serrated

**F7-070**  
 13 cm, 5 1/8"  
 smooth

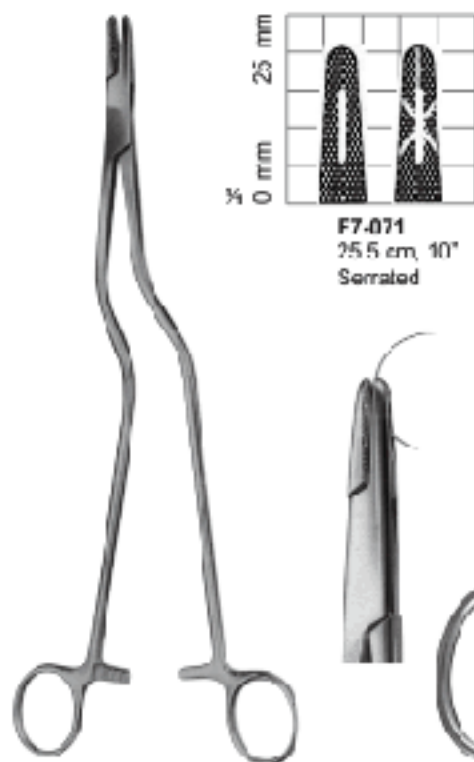

**Masson-Luethy Needle Holders**

**F7-071**  
 25.5 cm, 10"  
 Serrated

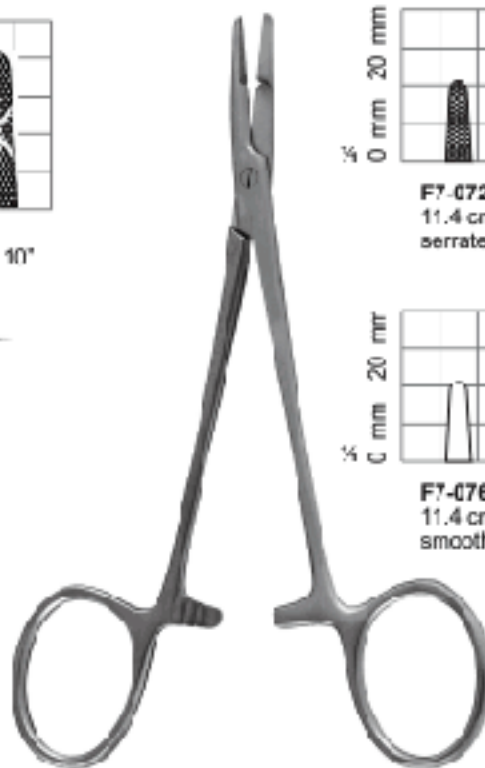

**Olsen-Hegar Needle Holders**

**F7-072**  
 11.4 cm, 4 1/2"  
 serrated

**F7-073**  
 14 cm, 5 1/2"  
 serrated

**F7-074**  
 17 cm, 6 3/4"  
 serrated

**F7-076**  
 19 cm, 7 1/2"  
 serrated

**F7-076**  
 11.4 cm, 4 1/2"  
 smooth

**F7-077**  
 14 cm, 5 1/2"  
 smooth

**F7-078**  
 17 cm, 6 3/4"  
 smooth

**F7-079**  
 19 cm, 7 1/2"  
 smooth

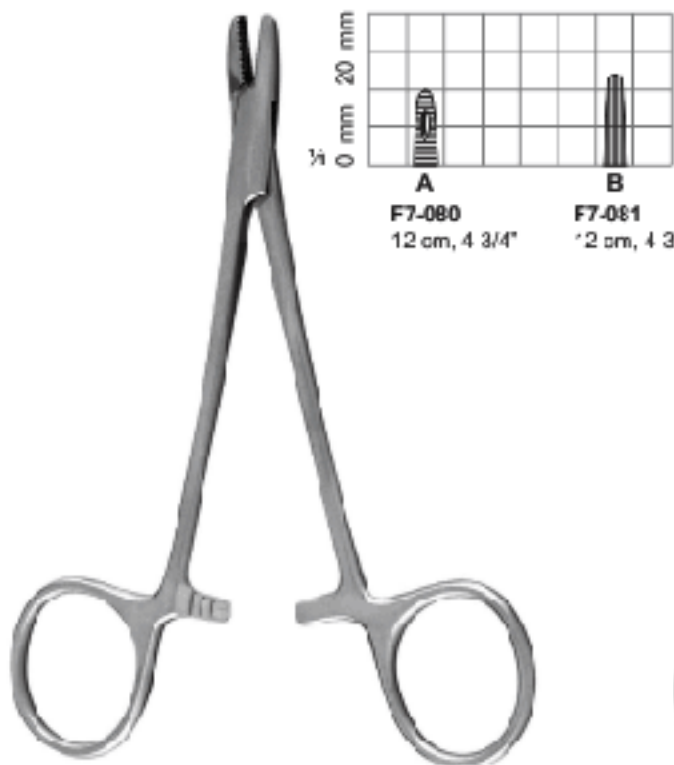

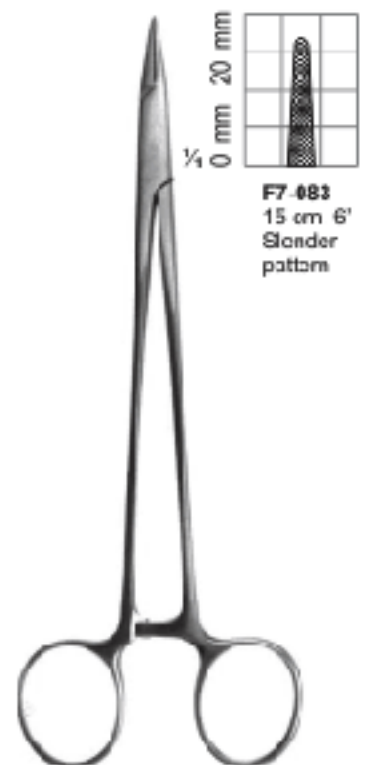
**Derf Needle Holders**

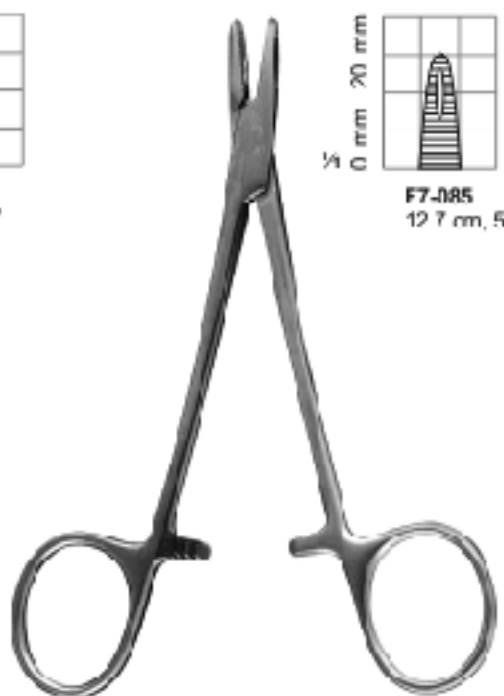
**Kilner Needle Holders**

**Crie-Murray Needle Holders**

**Neivert Needle Holders**

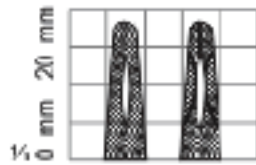
**Collier Needle Holders**

**Loyen Needle Holders**

*Nedelhaite* | *Porta-agujas*  
*Prote-aiguilles* | *Porta aghi*



**F7-087**  
 18.5 cm, 7 1/2"  
 One grooved and  
 fenestrated jaw

**Metzenbaum Needle Holders**

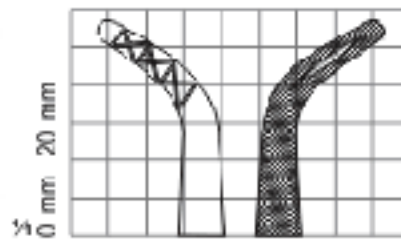

**F7-083**  
 27 cm, 10 1/4"

**Johnson Needle Holders**

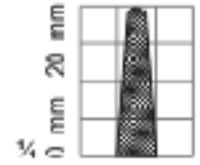

**F7-089**  
 26.5 cm, 10 1/2"  
 Serrated-Solid

**Wangensteen  
 Needle Holders**

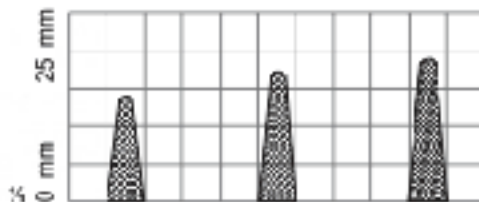

**F7-090**    **F7-091**    **F7-092**  
 14 cm, 5 1/2"    17 cm, 6 3/4"    20 cm, 8"

**Mathieu Needle Holders**

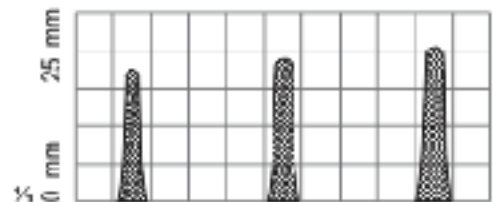

**F7-093**    **F7-094**    **F7-095**  
 14 cm, 5 1/2"    16.5 cm, 6 1/2"    20 cm, 8"  
 Narrow Jaws    Narrow Jaws    Narrow Jaws

**Mathieu Needle Holders**

Nedelhaier | Porta-agujas  
 Prote-aiguilles | Porta aghi

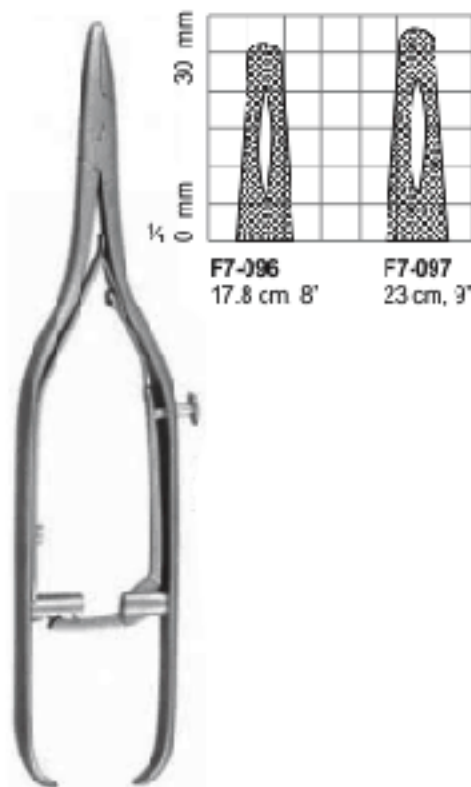

**F7-096** 17.8 cm 8"  
**F7-097** 23 cm, 9"

**Mayo Rochester Needle Holders**  
 button release, screw joint.

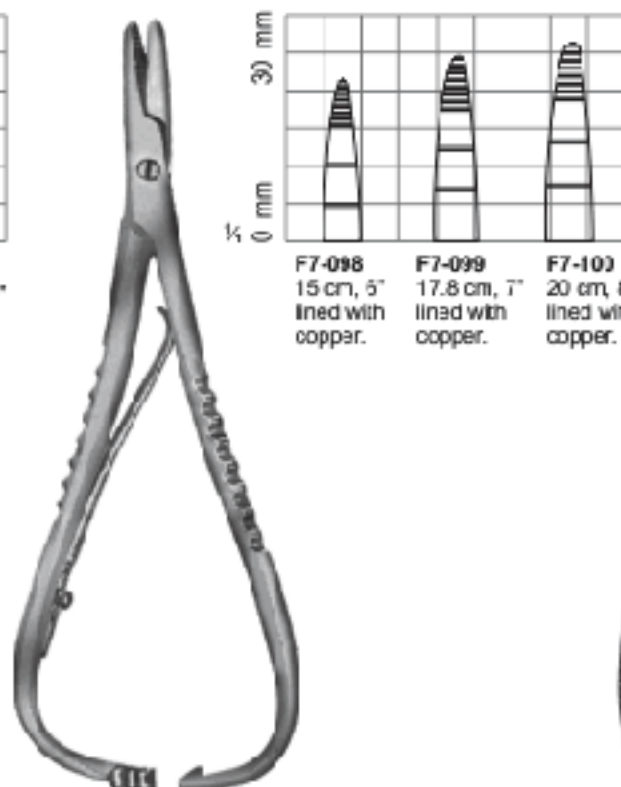

**F7-098** 15 cm, 5"  
 lined with copper.  
**F7-099** 17.8 cm, 7"  
 lined with copper.  
**F7-100** 20 cm, 8"  
 lined with copper.

**Macphail Needle Holders**

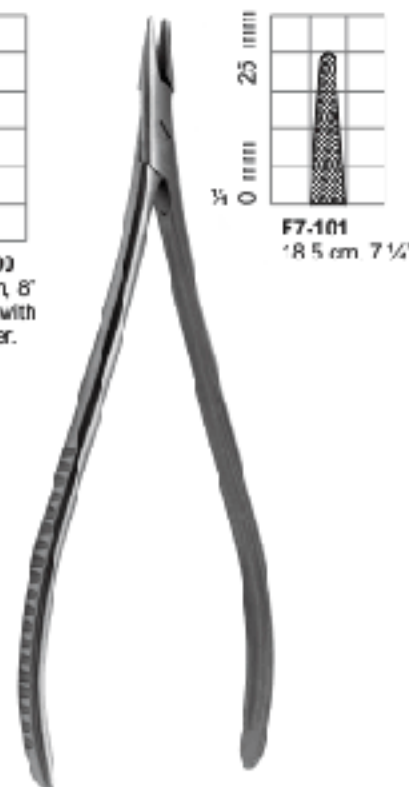

**F7-101**  
 18.5 cm 7 1/2"

**Toannis Needle Holders**

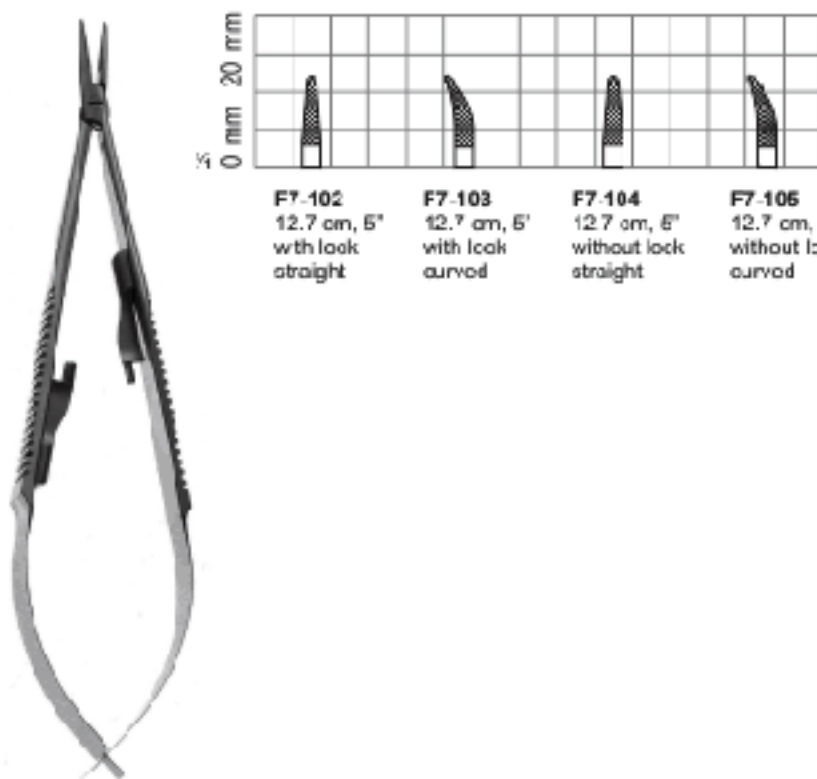

**F7-102** 12.7 cm, 5"  
 with lock straight  
**F7-103** 12.7 cm, 5"  
 with lock curved  
**F7-104** 12.7 cm, 5"  
 without lock straight  
**F7-105** 12.7 cm, 5"  
 without lock curved

**Castroviejo Needle Holders**

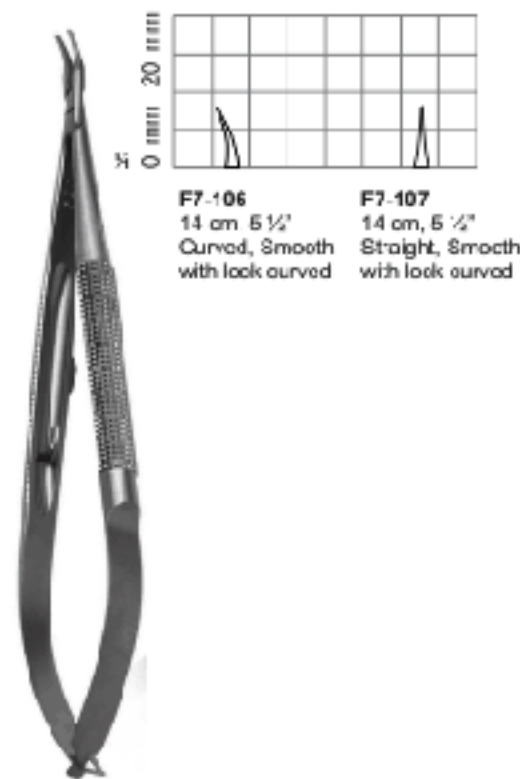

**F7-106** 14 cm 5 1/2"  
 Curved, Smooth with lock curved  
**F7-107** 14 cm, 5 1/2"  
 Straight, Smooth with lock curved

**Earraquar Needle Holders**

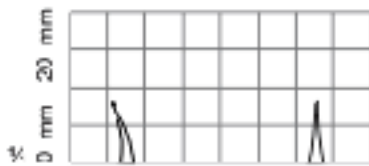

**F7-108**  
14 cm, 5 1/2"  
Curved, Smooth  
without lock  
curved

**F7-109**  
14 cm, 5 1/2"  
Straight, Smooth  
without lock  
curved

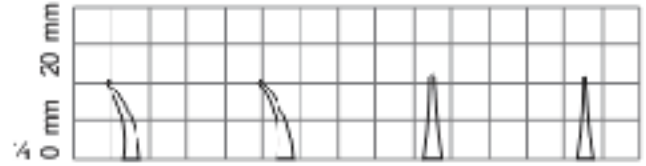

**F7-110**  
14 cm, 5 1/2"  
Curved  
Smooth  
with lock

**F7-111**  
14 cm, 5 1/2"  
Curved  
Smooth  
without lock

**F7-112**  
14 cm, 5 1/2"  
Straight  
Smooth  
with lock

**F7-113**  
14 cm, 5 1/2"  
Straight  
Smooth  
without lock

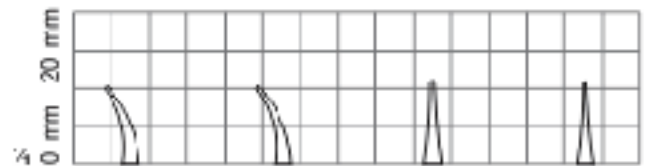

**F7-114**  
17.8 cm, 7"  
Curved  
Smooth  
with lock

**F7-115**  
17.8 cm, 7"  
Curved  
Smooth  
without lock

**F7-116**  
17.8 cm, 7"  
Straight  
Smooth  
with lock

**F7-117**  
17.8 cm, 7"  
Straight  
Smooth  
without lock

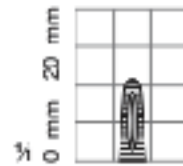
**Barraquer Needle Holders**
**Castroviejo Needle Holders**

**F7-120**  
12 cm, 5"

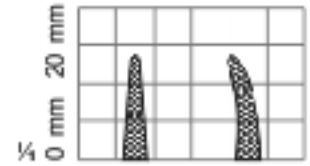
**Boynton Needle Holders**

**F7-121**   **F7-122**  
16 cm,   15 cm,  
6 1/2" Str.   6 1/2" Cvd.

**Arriga Needle Holders**
**Castroviejo Olsen Heager /  
Needle Holders / Scissors**

**F7-118** 14.5 cm, 6 3/4"

**F7-119** 15.0 cm, 6"



**F7-123** 19.5 cm, 7 1/4" Smooth Str.  
**F7-124** 23 cm, 9" Smooth Cvd.

**Micro Needle Holders**



**F7-125** 16 cm, 6 1/4" Smooth Cvd.

**Micro Needle Holders**

**F7-126** 12 cm, 5" Smooth Str with lock

**Castroviejo Needle Holders**

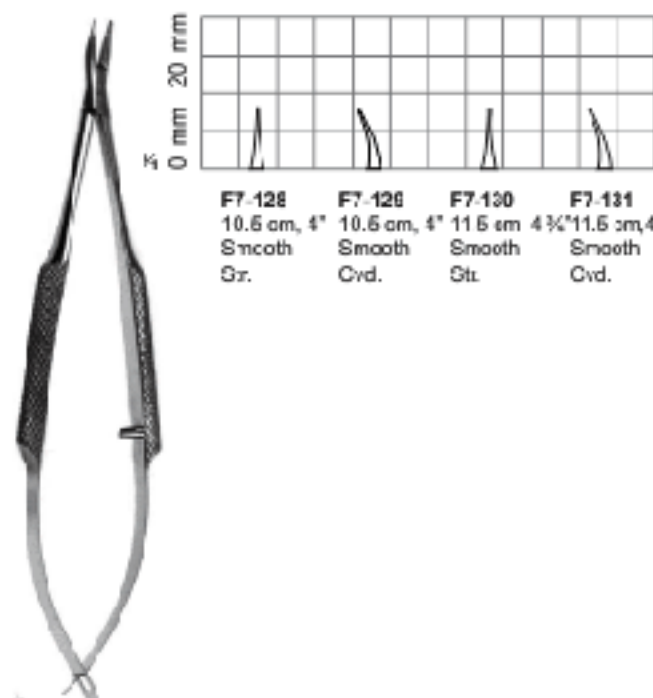

**F7-127** 12 cm, 5" Smooth Cvd with lock

**Castroviejo Needle Holders**

**F7-128** 10.6 cm, 4" Smooth Str.  
**F7-129** 10.6 cm, 4" Smooth Cvd.  
**F7-130** 11.6 cm, 4 1/2" Smooth Str.  
**F7-131** 11.6 cm, 4 1/2" Smooth Cvd.

**Barrsquer-Trautman Needle Holders**

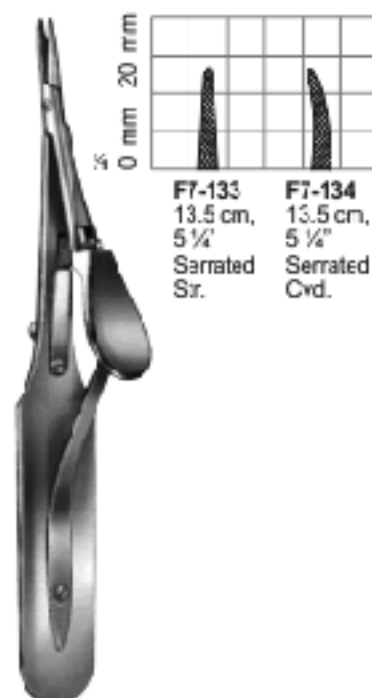
**F7-132** 13.5 cm, 5 1/4" Serrated

**Kalt Needle Holders**

**F7-133** 13.5 cm, 5 1/4" Serrated Str.  
**F7-134** 13.5 cm, 5 1/4" Serrated Cvd.

**Arruga Needle Holders**

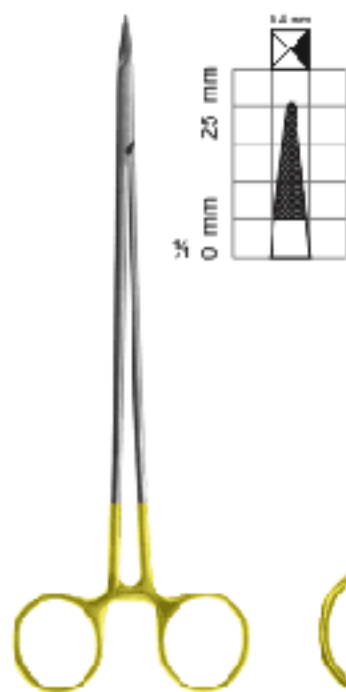

**MICROVASCULAR**  
**Needle Holders T.C.**  
 T.C F7-135 17.8 cm, 7"  
 T.C F7-136 20 cm, 8"  
 T.C F7-137 22 cm, 8 1/2"  
 T.C F7-138 25 cm, 10"

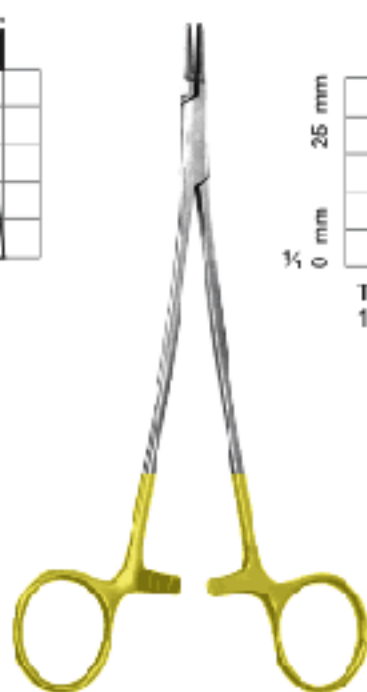

**Micro Ryder Needle**  
 **Holders T.C.**

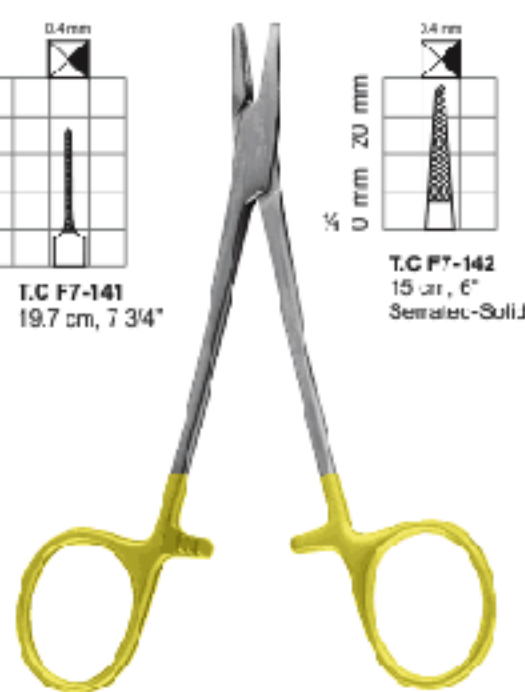
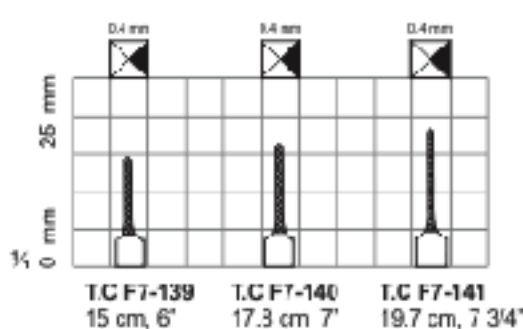

**Carroll Needle Holders T.C.**

**T.C F7-142**  
 15 cm, 6"  
 Sematec-Sulij

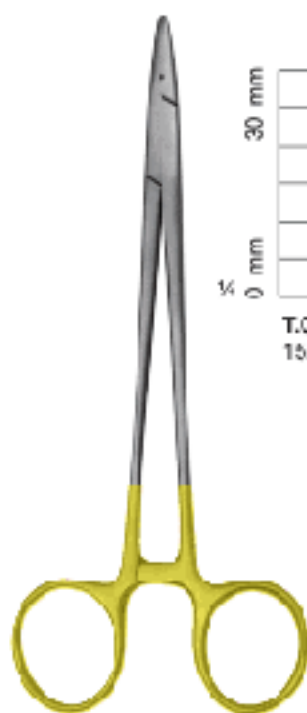

**Crile-Wood Needle**  
 **Holders T.C.**

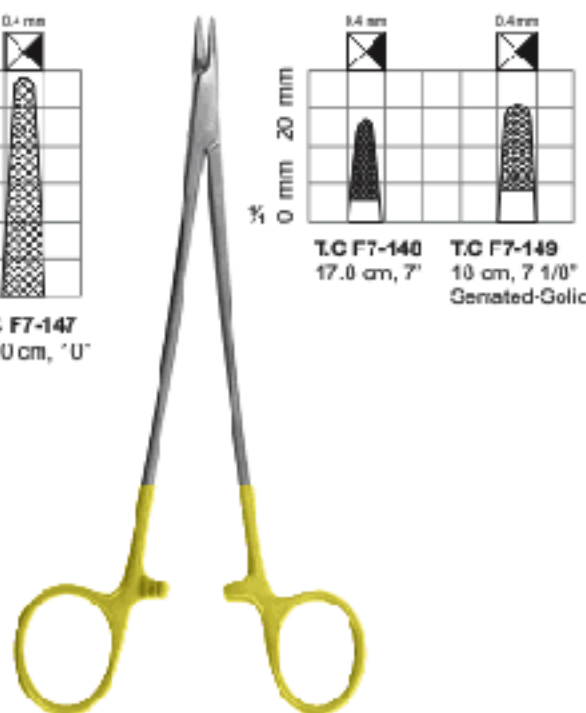
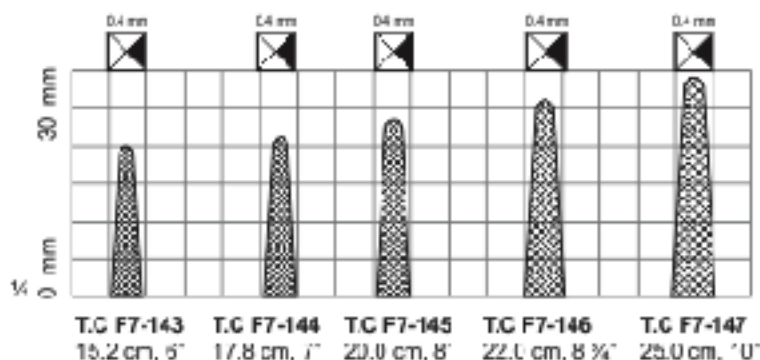

**New Orleans Needle**  
 **Holders T.C.**

**T.C F7-148** 17.0 cm, 7"  
**T.C F7-149** 10 cm, 7 1/8"  
 Genated-Golic

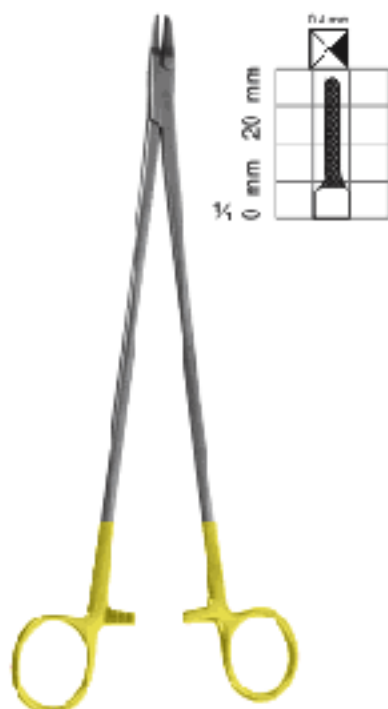

**Intracardiac Needle Holders T.C.**  
 T.C F7-150 18 cm, 7"  
 T.C F7-151 20 cm, 8"  
 T.C F7-152 22 cm, 8 1/2"  
 T.C F7-153 25 cm, 10"

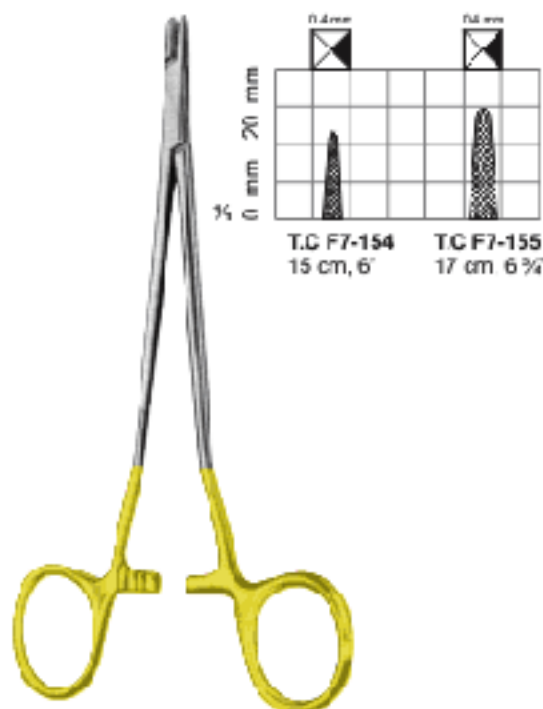

**Seaming Needle Holders T.C**  
 (Schwed. Model)

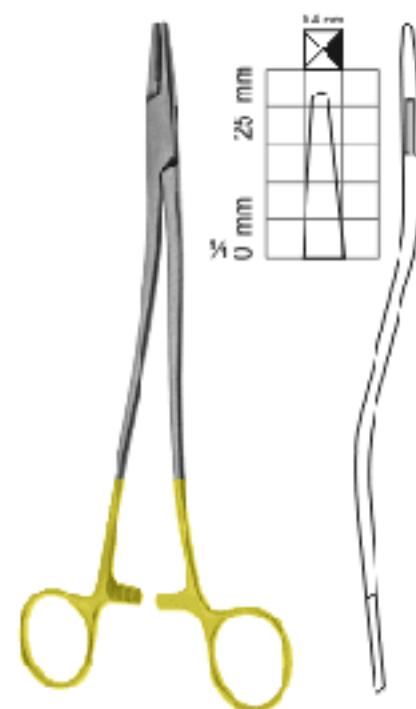

**Wertheim Needle Holders T.C**  
 T.C F7-156 20 cm, 8"  
 T.C F7-157 24 cm, 9 1/2"

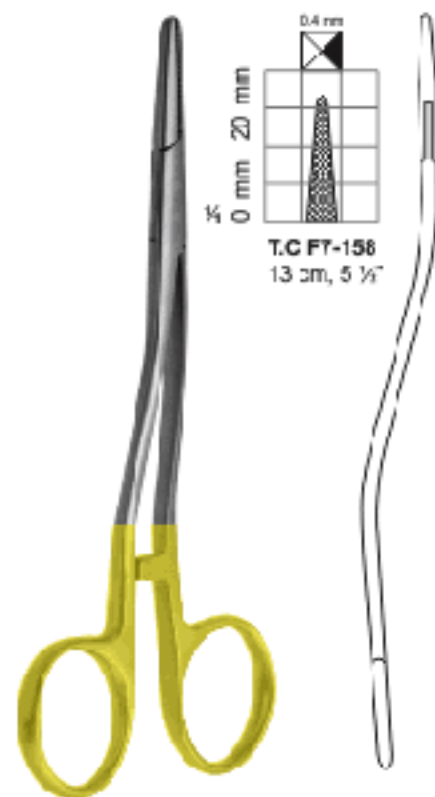

**Kilner Needle Holders T.C**

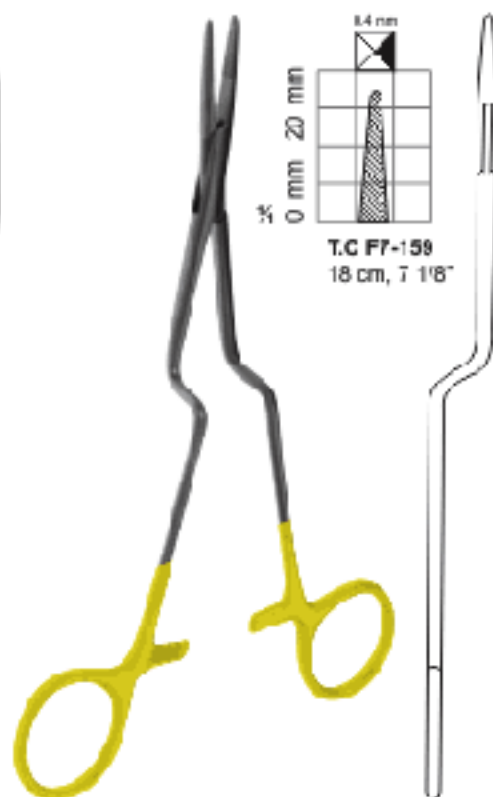

**Jacobson Needle Holders T.C**

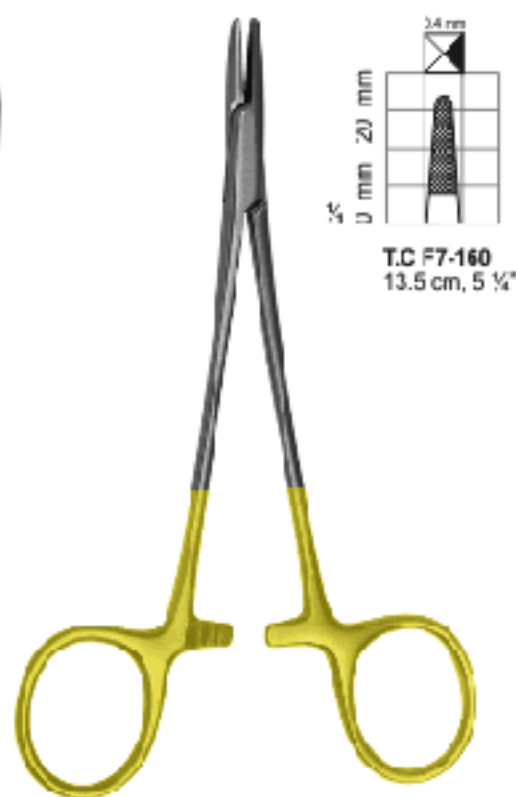

**Baumgartner Needle Holders T.C**



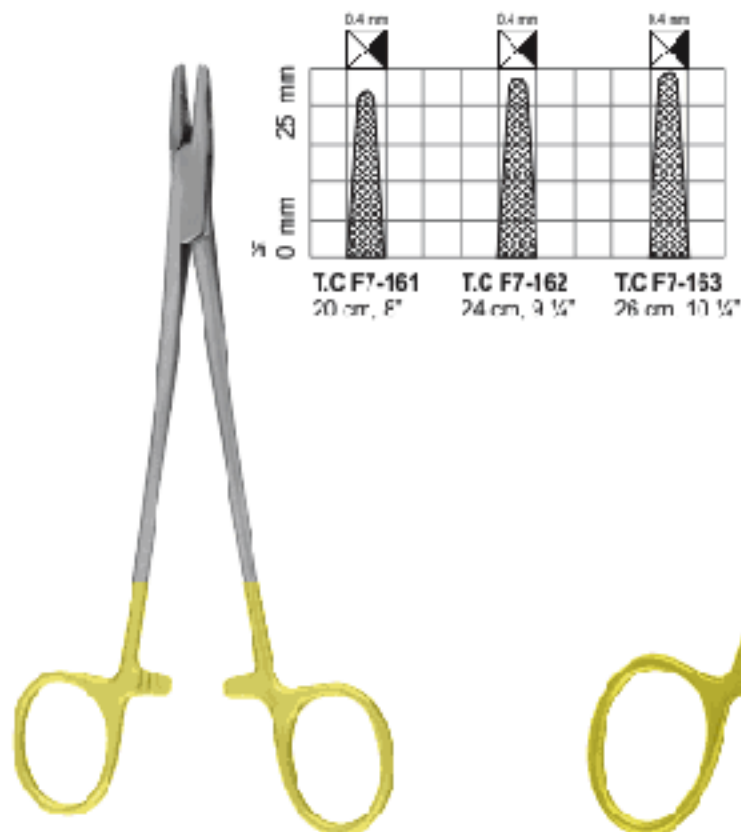
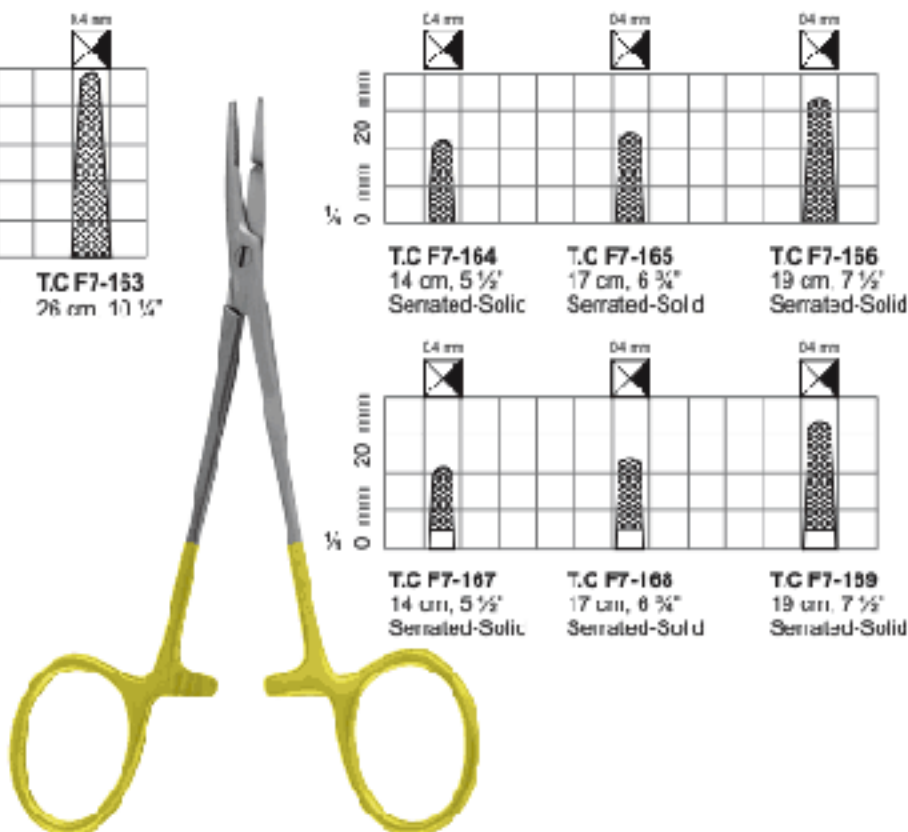
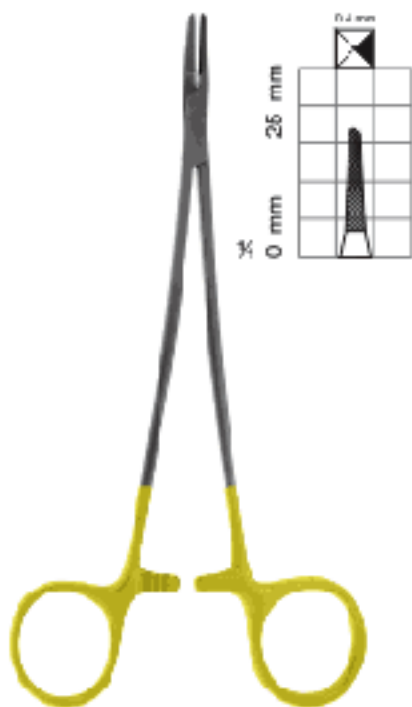

**Bozemann Needle Holders T.C**

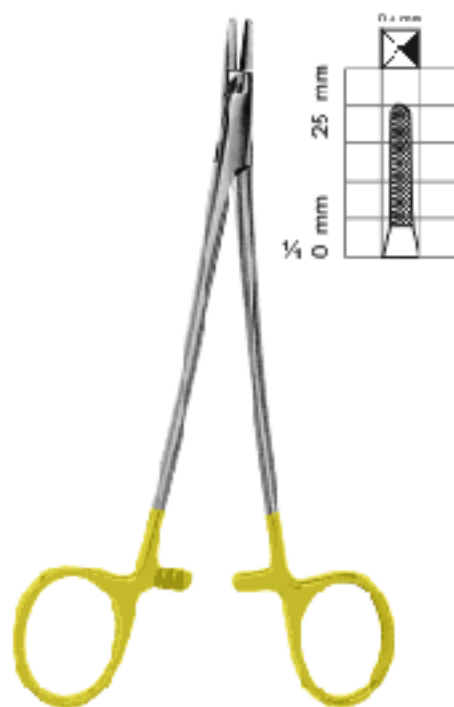
**Olsen-Hegar Needle Holders T.C**

**French-Eye Needle Holders T.C**

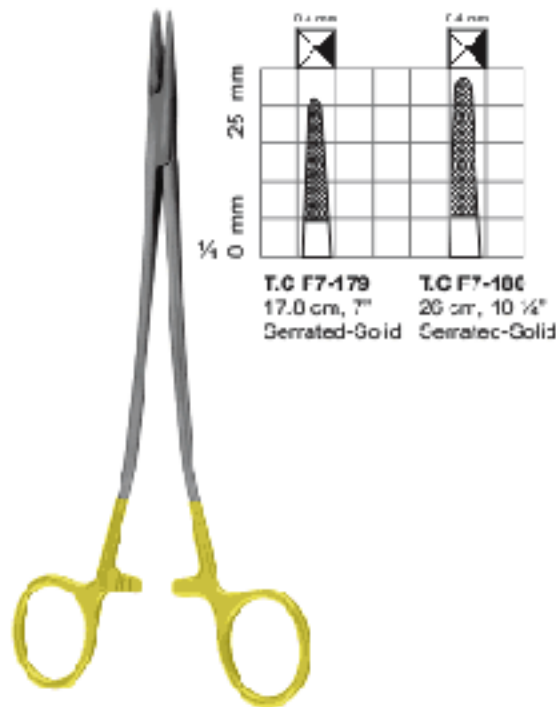
- T.C F7-170 16 cm, 6 1/4"
- T.C F7-171 17.8 cm, 7"
- T.C F7-172 20 cm, 8"
- T.C F7-173 22 cm, 8 3/4"
- T.C F7-174 25 cm, 10"

**French-Eye Needle Holders T.C**

- T.C F7-175 15.2 cm, 6"
- T.C F7-176 17.8 cm, 7"
- T.C F7-177 20.3 cm, 8"
- T.C F7-178 25.4 cm, 10"

**Sarco Needle Holders T.C**

- T.C F7-179 17.0 cm, 7"
- T.C F7-180 26 cm, 10 1/4"

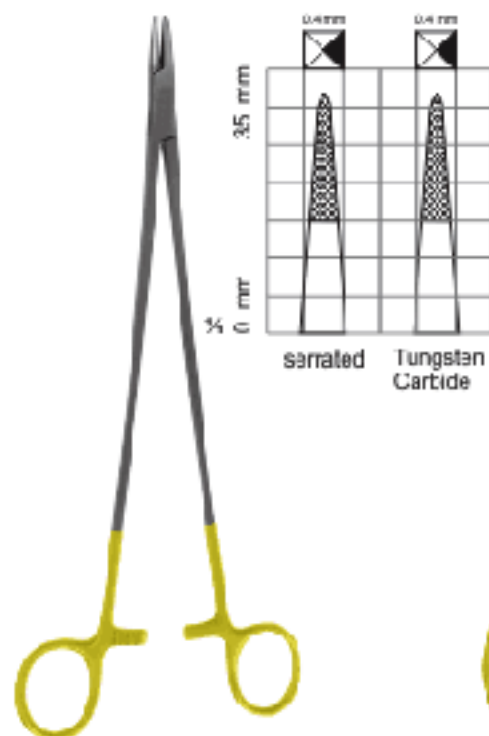

**Wargenstein Needle Holders T.C**  
**T.C F7-101**  
 27.3 cm, 10 3/4"

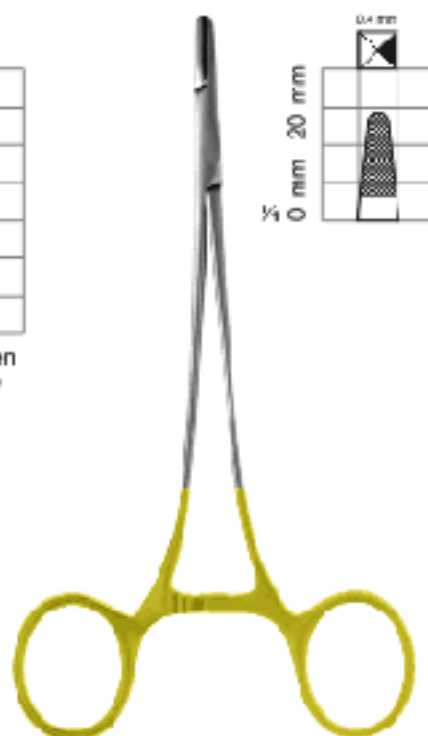

**Finocchio Needle Holders T.C**  
**T.C F7-182** 13 cm, 5 1/4"  
**T.C F7-183** 16 cm, 6 1/4"  
**T.C F7-184** 19 cm, 7 1/2"  
**T.C F7-185** 21 cm, 8 1/4"

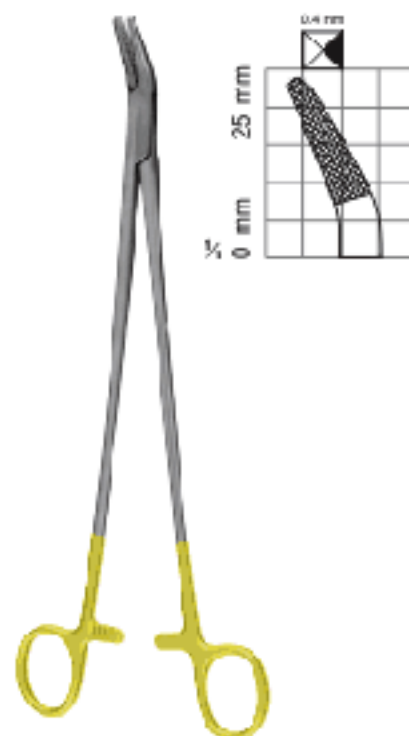

**Finocchio Needle Holders T.C**  
**T.C F7-186** 13 cm, 5 1/4"  
**T.C F7-187** 16 cm, 6 1/4"  
**T.C F7-188** 19 cm, 7 1/2"



**Mayo-Hegar Needle Holders T.C**  
 Also Available Right Handle

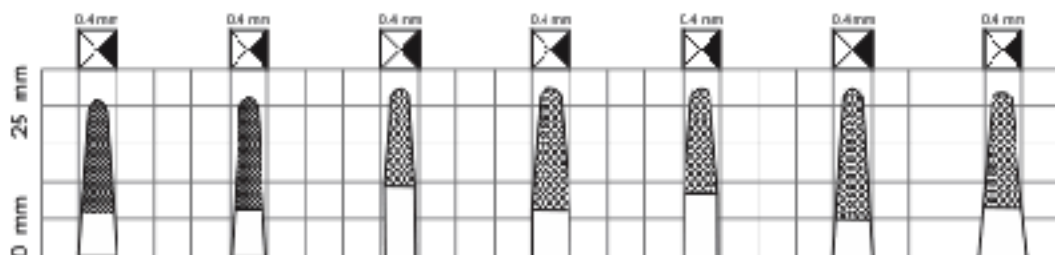

<b>T.C F7-189</b> 16 cm, 6 1/4" T.C F7-190 17.3 cm, 7" Lef. handed.	<b>T.C F7-191</b> 20 cm, 8" T.C F7-192 20 cm, 8" Left handed.	<b>T.C F7-193</b> 15.2 cm, 6" T.C F7-194 15.2 cm, 6" Left handed.	<b>T.C F7-195</b> 17.8 cm, 7" T.C F7-196 17.8 cm, 7" Left handed.	<b>T.C F7-197</b> 20.5 cm, 8" T.C F7-198 20.5 cm, 8" Left handed.	<b>T.C F7-199</b> 23 cm, 9" T.C F7-203 23 cm, 9" Left handed.	<b>T.C F7-201</b> 25 cm, 10" T.C F7-202 25 cm, 10" Left handed.
---	---	---	---	---	---	---

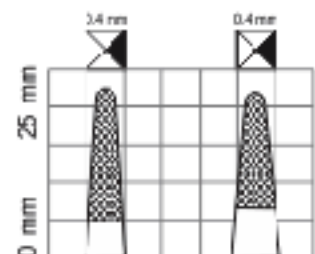

<b>T.C F7-203</b> 27.64 cm, 11" T.C F7-204 27.64 cm, 11" Left hencec.	<b>T.C F7-205</b> 29.8 cm, 12" T.C F7-206 29.8 cm, 12" Left handed.
---	---

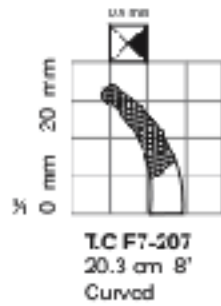
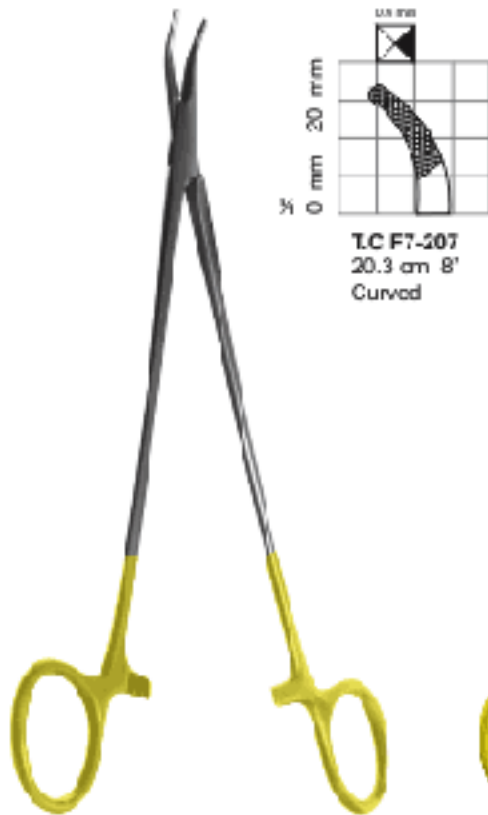
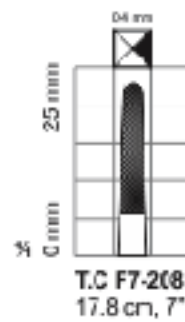
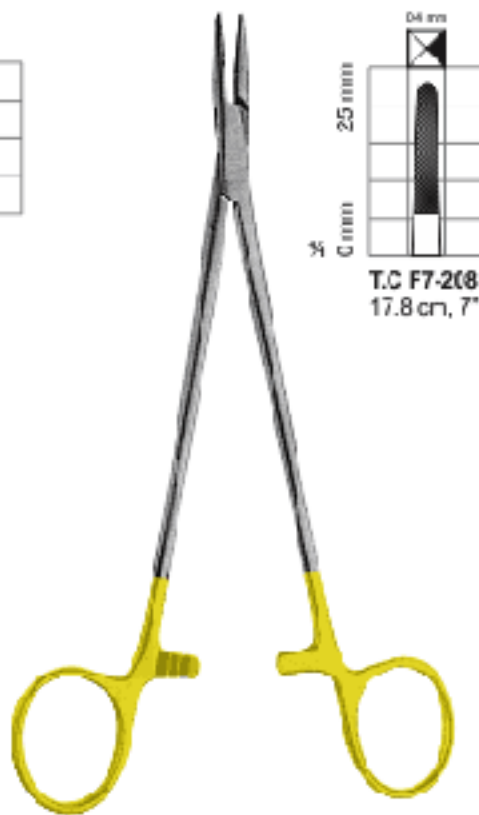
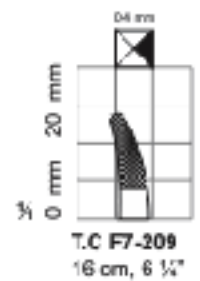
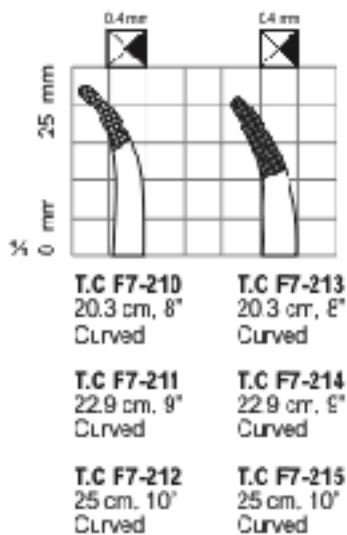
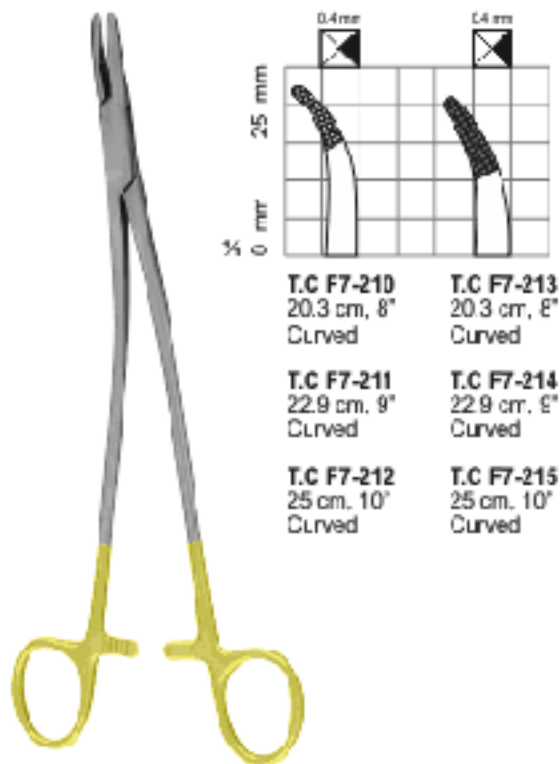
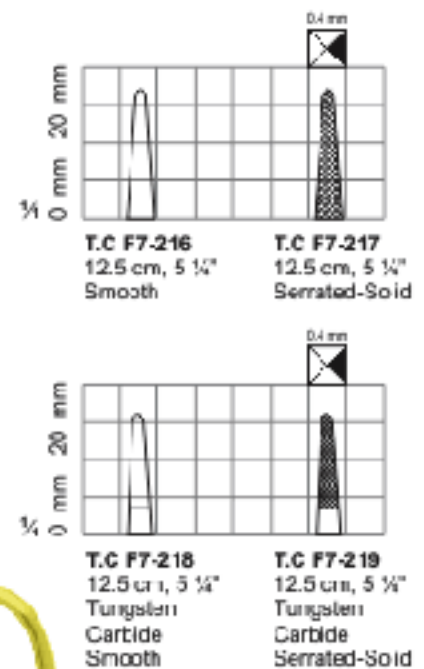

**Finochietto Needle Holders T.C**

**Rochester Needle Holders T.C**

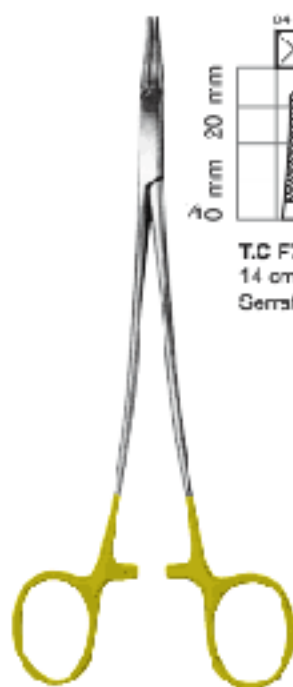
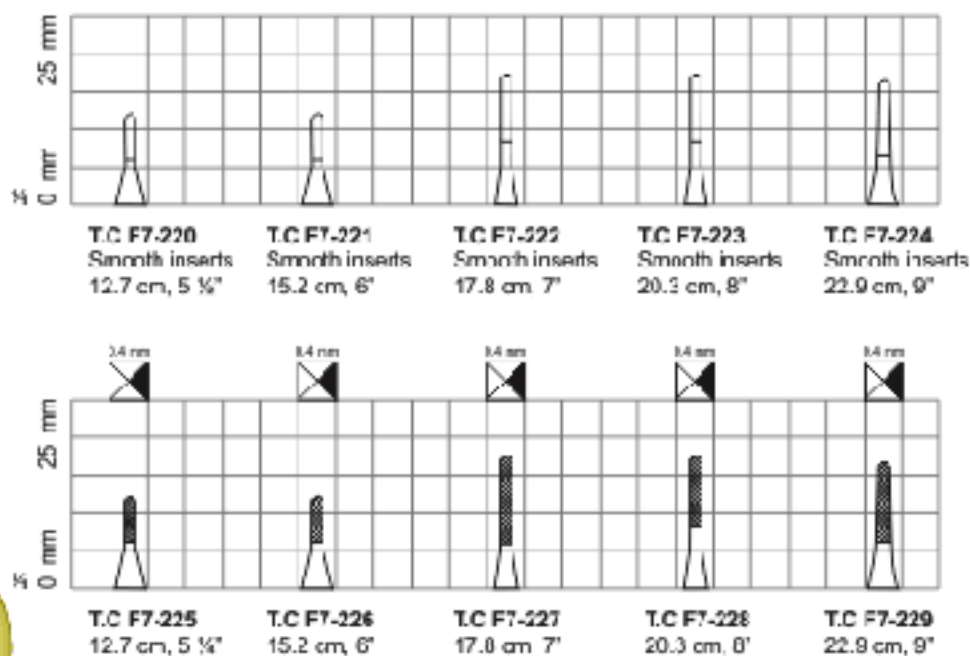
**Gillies Needle Holders T.C**

**Stratton Needle Holders T.C**

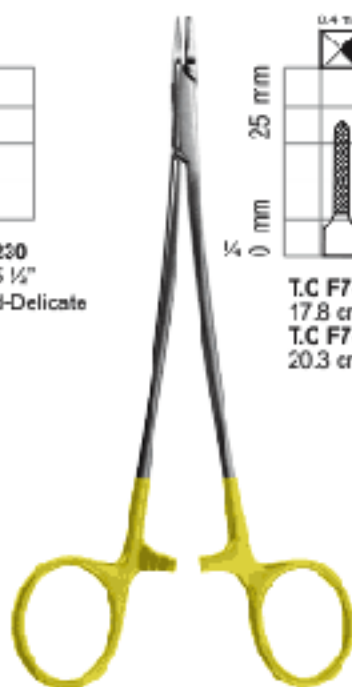
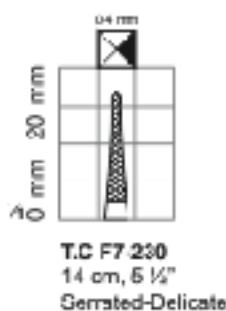
**Halsey Needle Holders T.C**



**Ryder Needle Holders T.C**  
Narrow jaws.



**Eufrate Pasque T.C**  
Needle Holders



**Cooley Intracardiac Needle Holders T.C**  
Narrow Jaw.

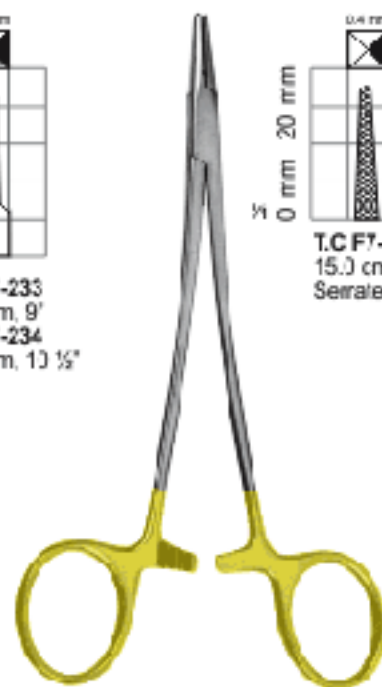
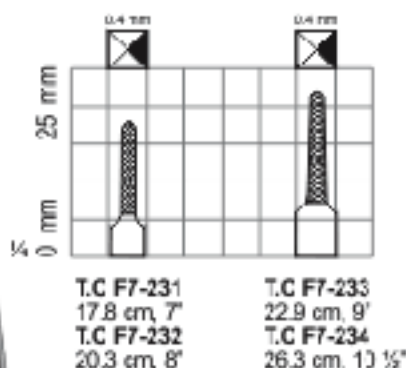

**Baby Crile Wood Needle Holders T.C**

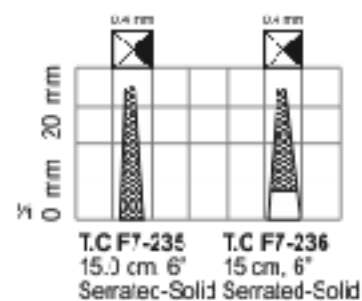

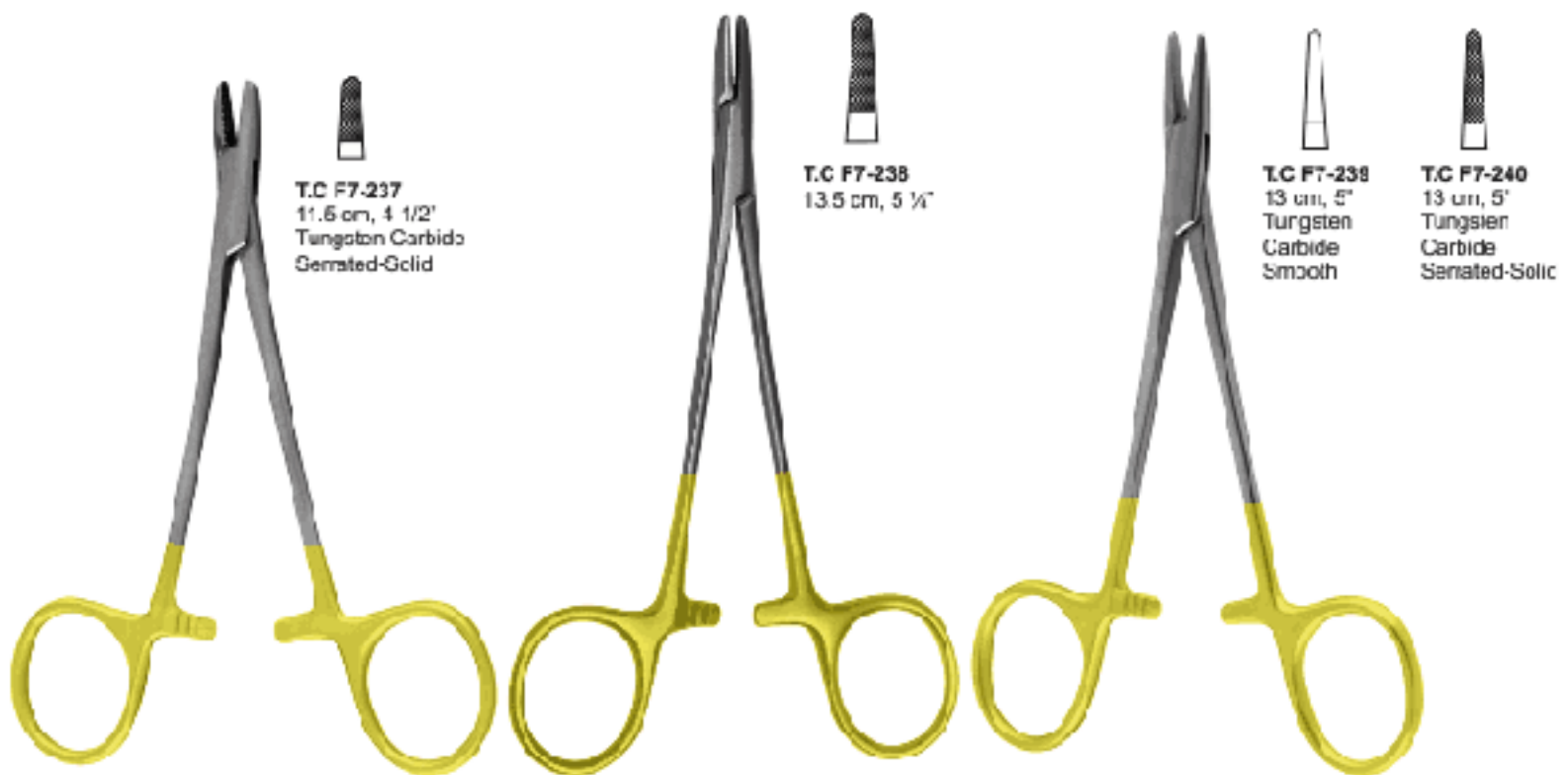

**T.C F7-237**  
 11.6 cm, 4 1/2"  
 Tungsten Carbide  
 Gemated-Gold

**T.C F7-238**  
 13.5 cm, 5 1/4"

**T.C F7-238**  
 13 cm, 5"  
 Tungsten  
 Carbide  
 Smooth

**T.C F7-240**  
 13 cm, 5"  
 Tungsten  
 Carbide  
 Serrated-Sollic

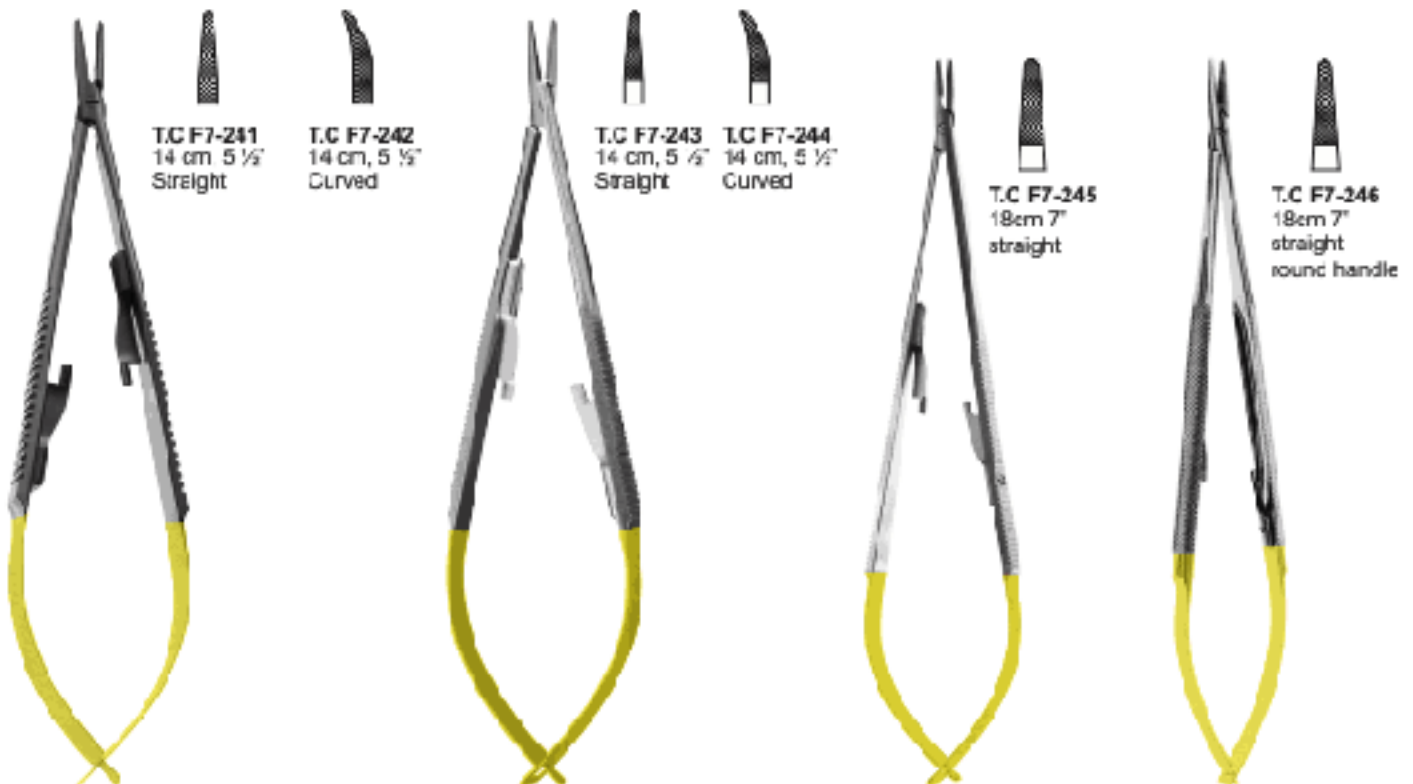
**Derf Needle Holders T.C**
**Baumgartner Needle Holders T.C**
**Halsey Needle Holders T.C**

**T.C F7-241**  
 14 cm, 5 1/2"  
 Straight

**T.C F7-242**  
 14 cm, 5 1/2"  
 Curved

**T.C F7-243**  
 14 cm, 5 1/2"  
 Straight

**T.C F7-244**  
 14 cm, 5 1/2"  
 Curved

**T.C F7-245**  
 18cm 7"  
 straight

**T.C F7-246**  
 18cm 7"  
 straight  
 round handle

**Castroviejo Needle Holders T.C**
**Castroviejo Needle Holders T.C**
**Castroviejo  
 Needle Holders  
 T.C**
**Castroviejo Needle Holders T.C**

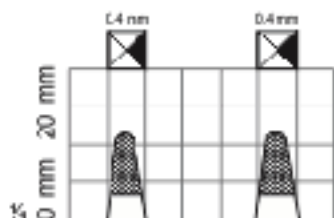

**T.C F7-247**  
 15.2 cm, 6"  
 Delicate.

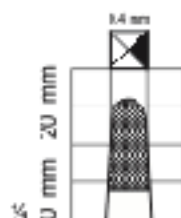
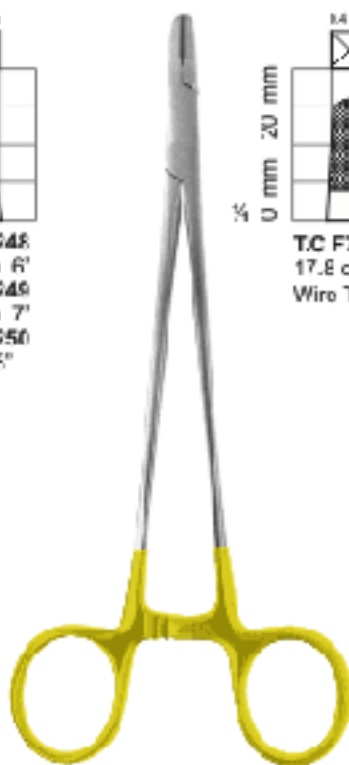
**T.C F7-248**  
 15.2 cm, 6"  
**T.C F7-249**  
 17.3 cm, 7"  
**T.C F7-250**  
 20 cm, 8"  
 Heavy

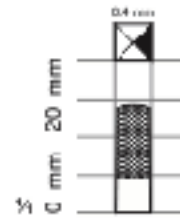
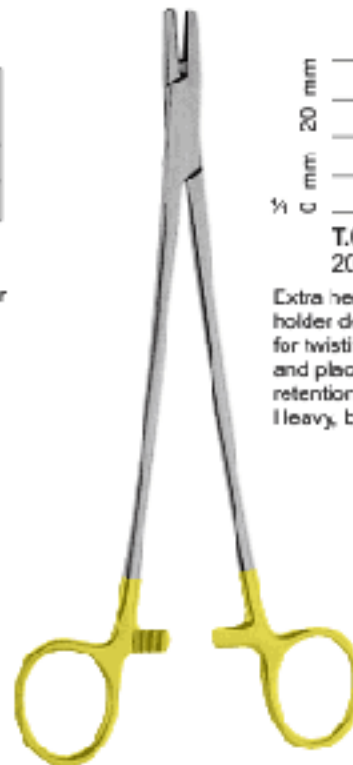
**Wire Twisters Needle Holders T.C**

**T.C F7-251**  
 17.8 cm, 7"  
 Wire Twister

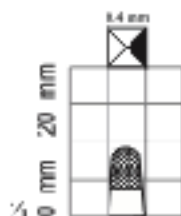
**Sternum Needle Holders T.C**

**T.C F7-252**  
 20.3 cm, 8"

Extra heavy needle holder designed for twisting of wire and placement of retention suture. Heavy, blunt jaws.

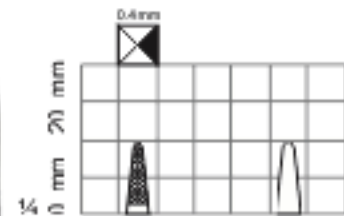
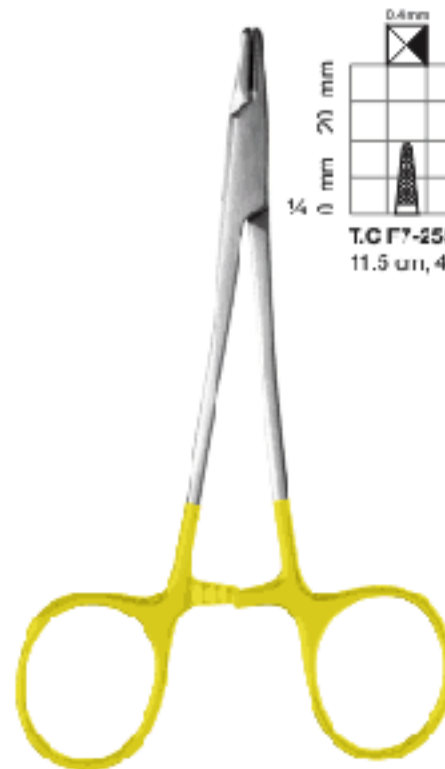
**Cooley-Baumgarten Wire Twister Needle Holders T.C**

**T.C F7-253**  
 12.7 cm, 5 1/4"

**Rubio Wire Twister Needle Holders T.C**

**Wire Tightening Needle Holders T.C**  
**T.C F7-254** 13 cm 7"

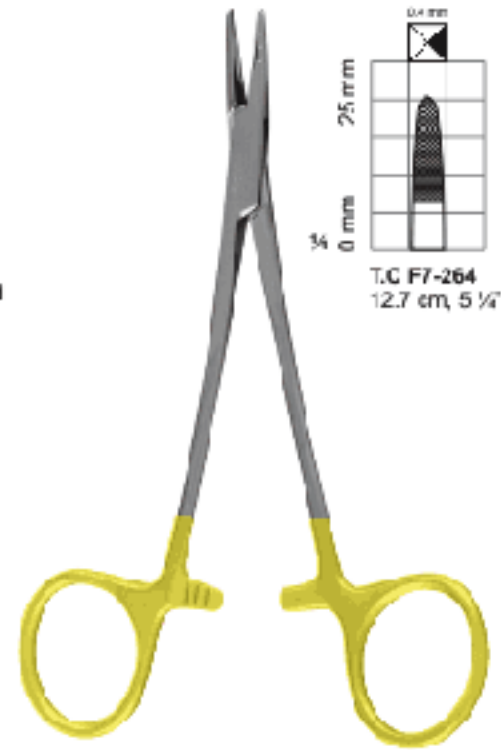
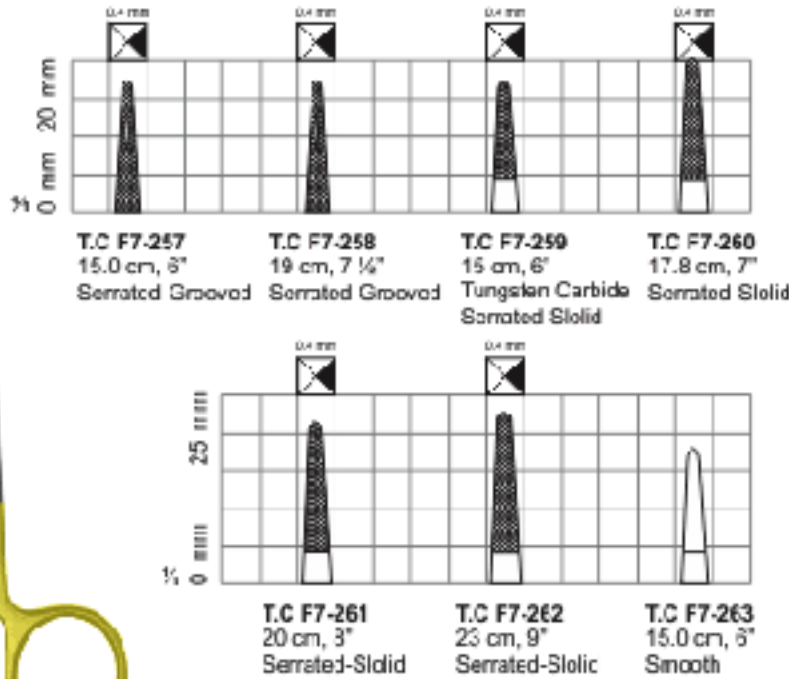
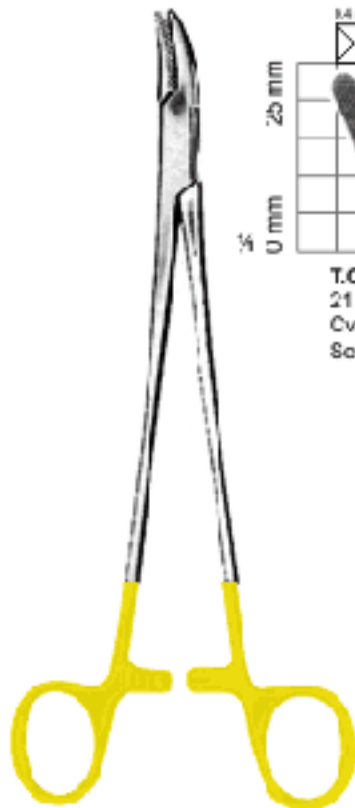
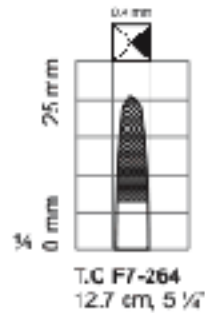
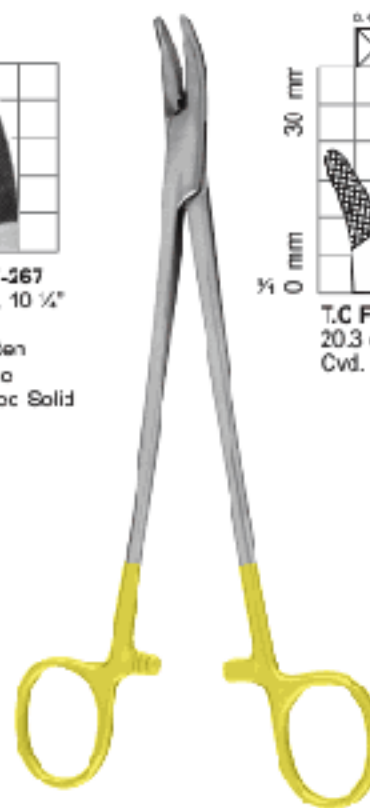
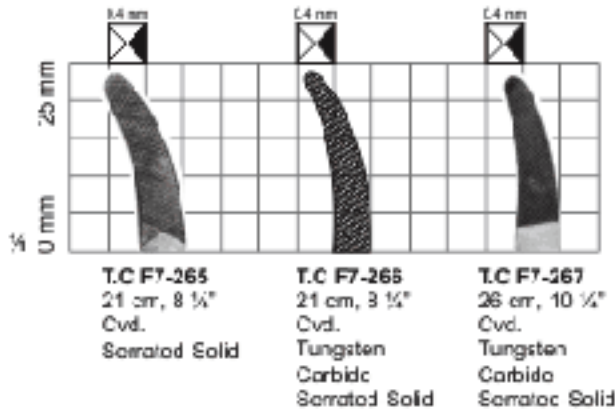
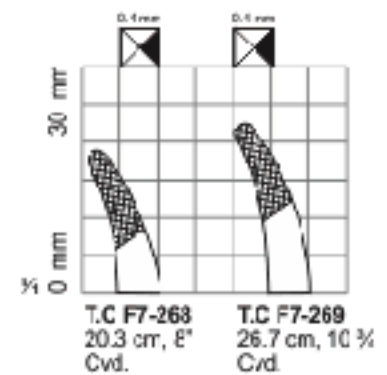
**T.C F7-255** 11.5 cm, 4 3/4"  
**T.C F7-256** 11.5 cm, 4 3/4"  
 Small

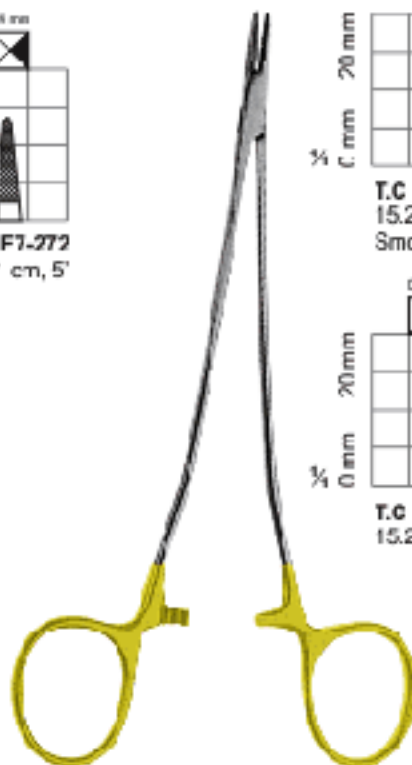
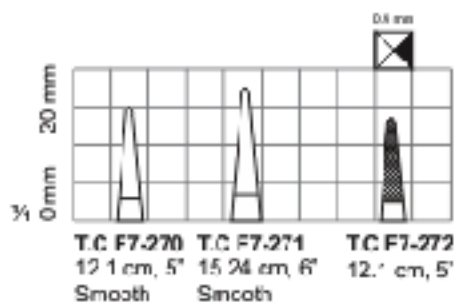
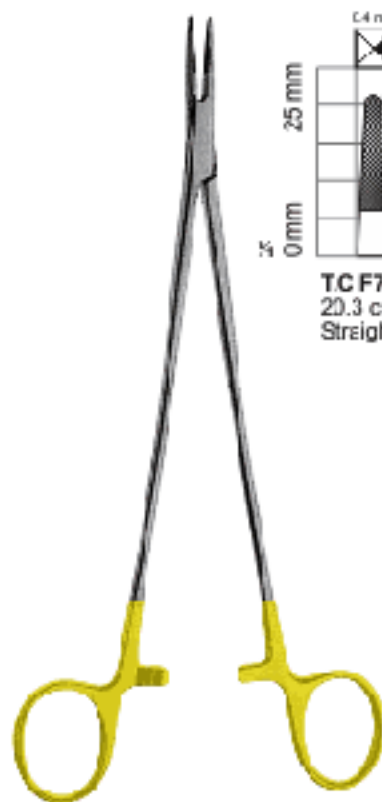
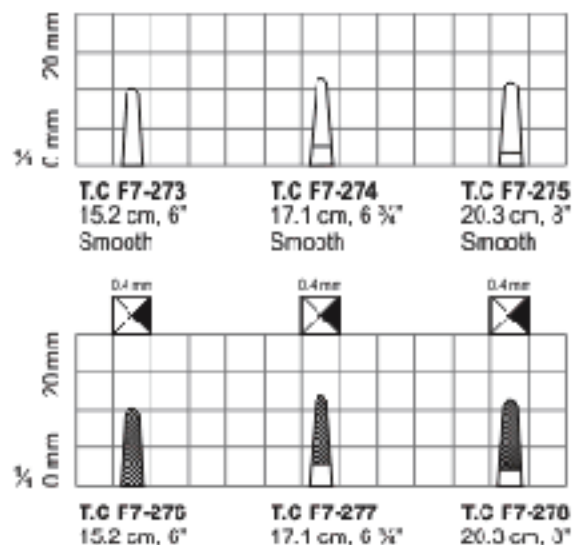
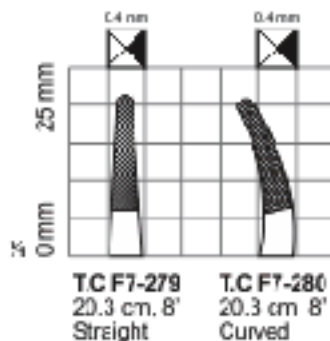
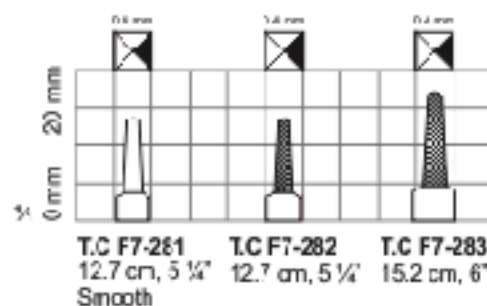
**Micro Derf Needle Holders T.C**

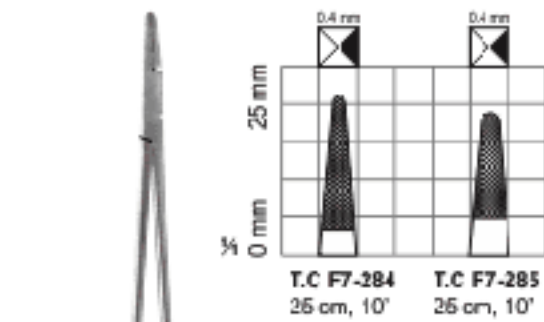

**Crisle-Wood Needle Holders T.C**

**Neivert Needle Holders T.C**

**Heaney-Gyne Needle Holders T.C**

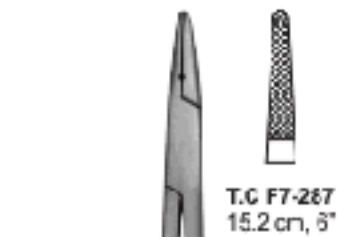
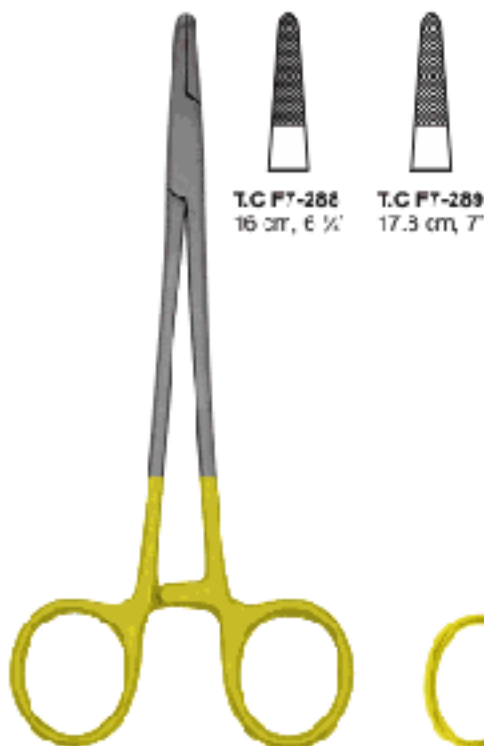
**Heaney Needle Holders T.C**

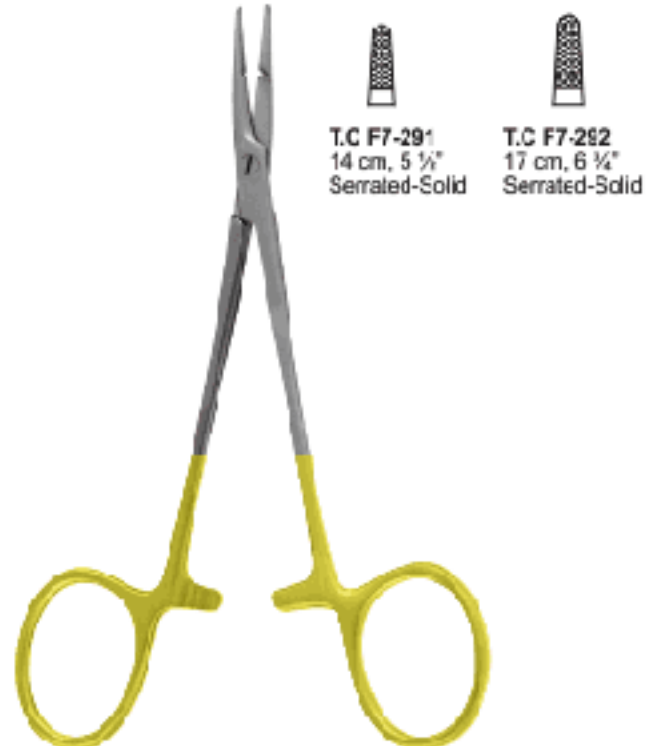

**Webster Needle Holders T.C**

**Cooley Microvascular Needle Holders T.C**

**Julian Needle Holders T.C**

**Micro Surgical Needle Holders T.C**





**Masson Needle Holders T.C**

**Webster Needle Holders T.C**

**Crile-Wood Needle Holders T.C.**

**Mayo-Hegar Needle Holders T.C**  
 Also Available Right: Handle

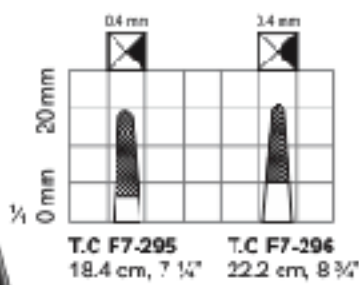
**De Bakkey Needle Holders T.C**  
 T.C F7-290  
 17.8 cm, 7"  
 Delicate

**Olsen-Hegar Needle Holders T.C**



**Arruga Needle Holders T.C**  
**T.C F7-293** 16 cm, 5 1/4" Str.  
**T.C F7-294** 16 cm, 5 1/4" Cvd.

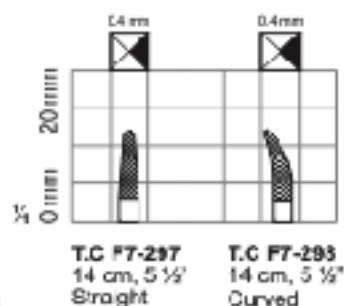

**Castroviejo Needle Holders T.C**



**Castroviejo Needle Holders T.C**

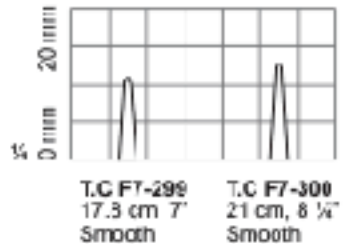

**Jacobson Needle Holders T.C**

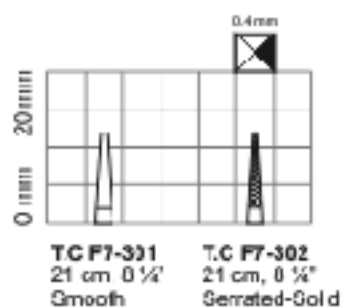

**Castroviejo Needle Holders T.C**

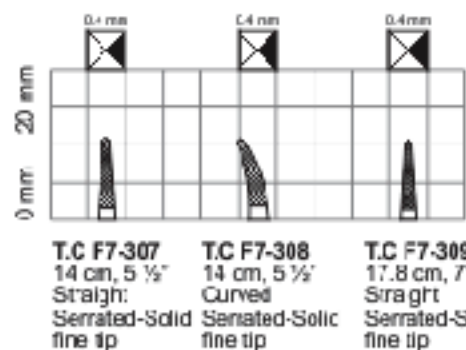
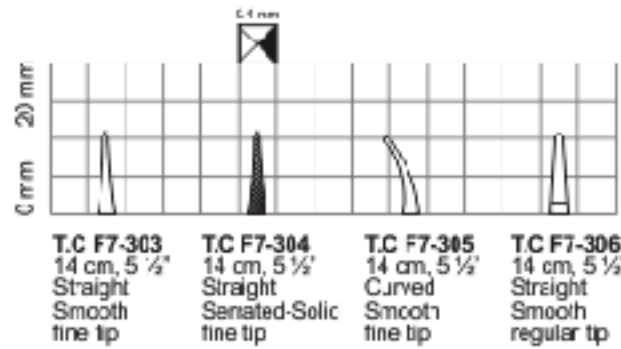

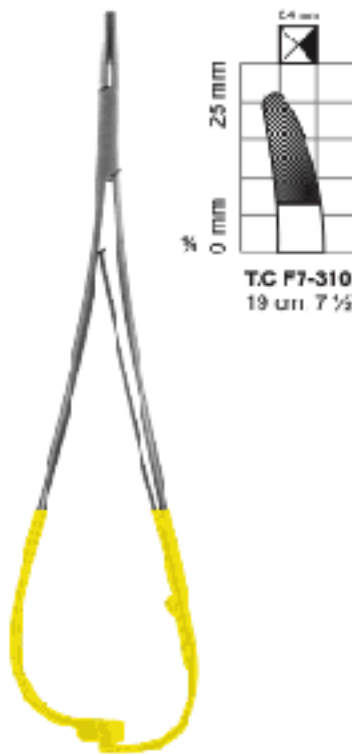

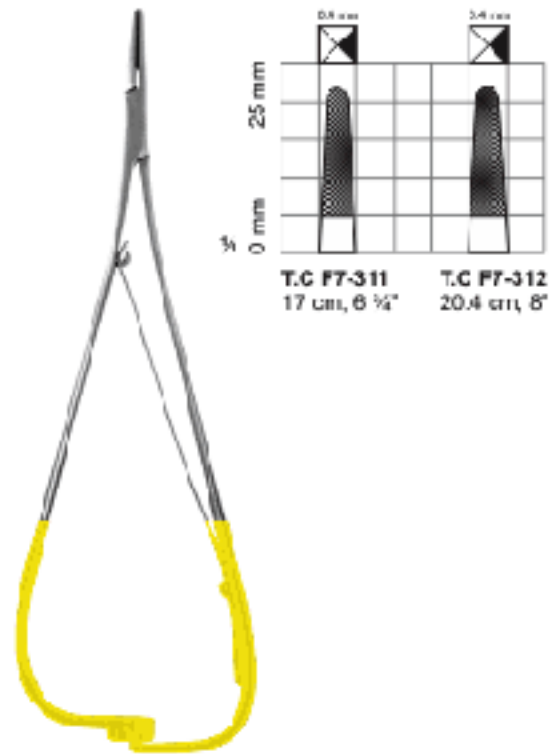
**T.C F7-310**  
 19 cm, 7 1/2"

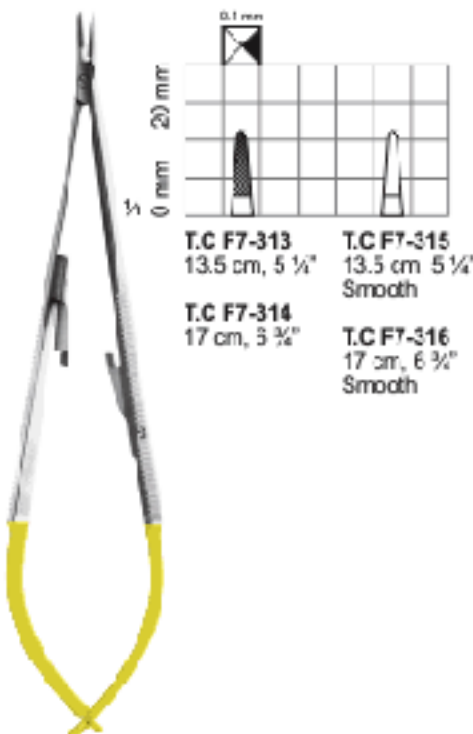
**Metzenbaum Needle Holders T.C**

**T.C F7-311** 17 cm, 6 1/2"     **T.C F7-312** 20.4 cm, 8"

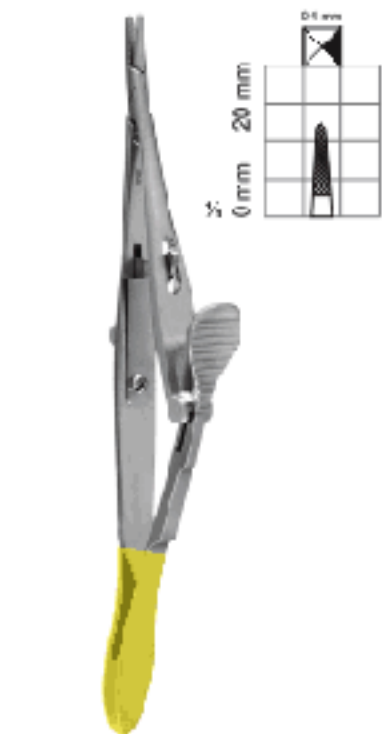
**Mathieu-Style Needle Holders T.C**

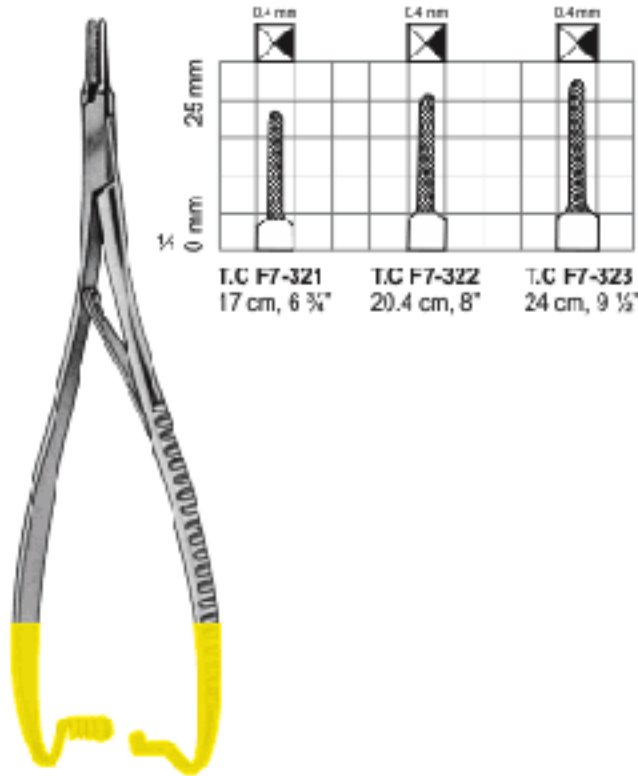
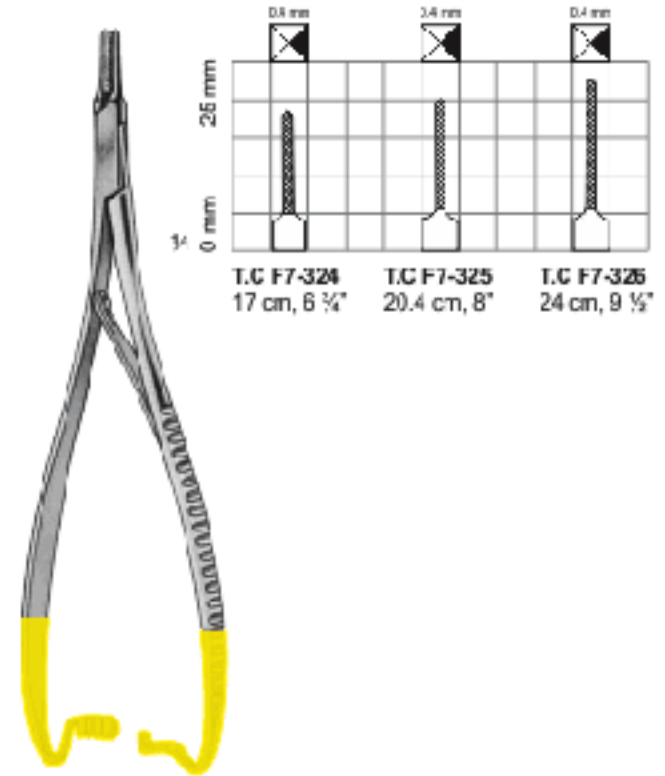
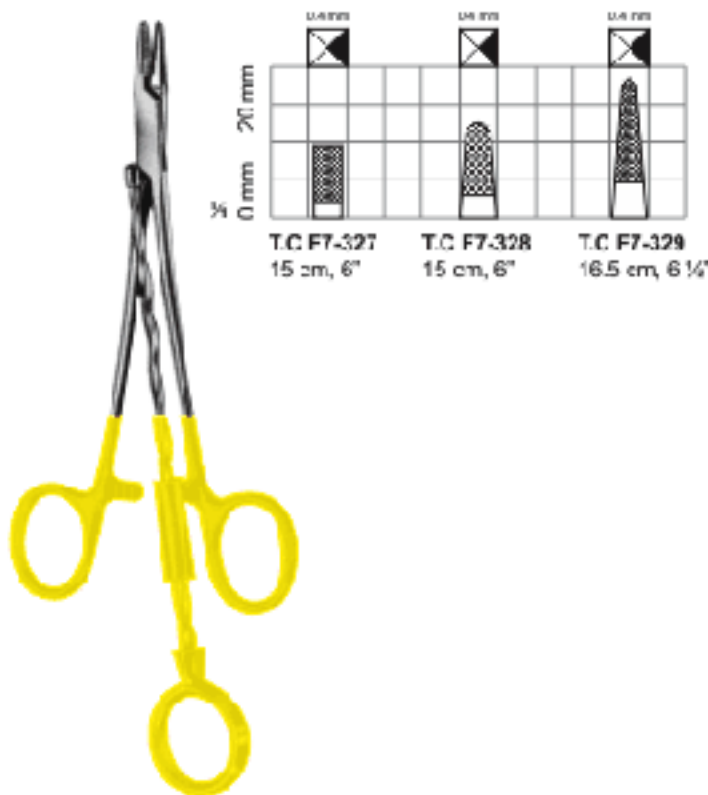
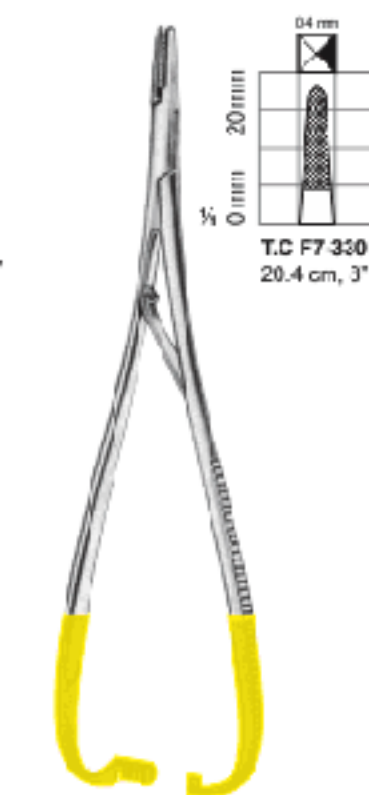
**T.C F7-313** 13.5 cm, 5 1/4"     **T.C F7-315** 13.5 cm, 5 1/4" Smooth  
**T.C F7-314** 17 cm, 5 3/4"     **T.C F7-316** 17 cm, 6 3/4" Smooth

**Castroviejo Needle Holders T.C**

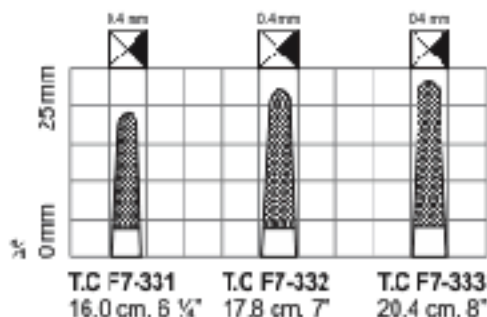
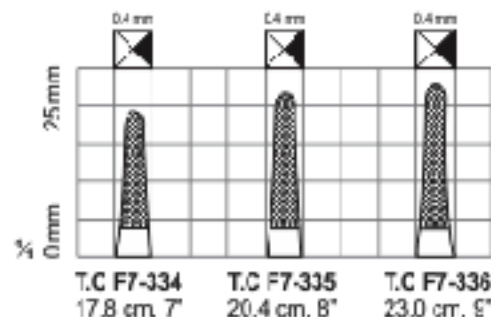
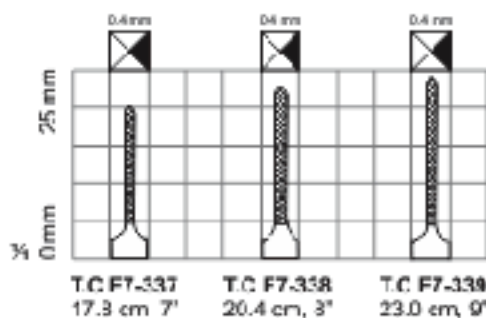
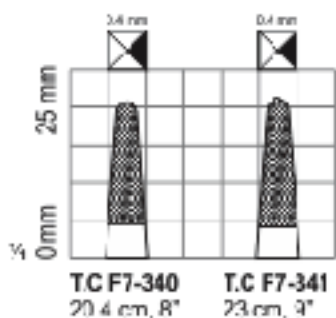
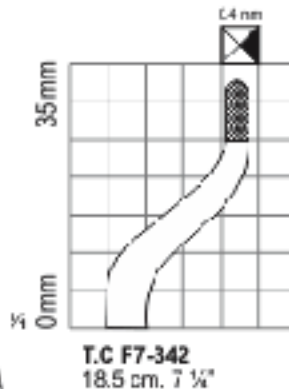
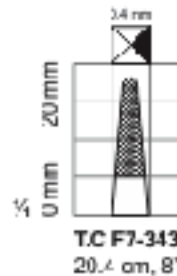
**Jacobsen Heavy Style Needle Holders T.C**  
**T.C F7-317** 19.0 cm, 7 1/2"  
**T.C F7-318** 22.9 cm, 9"  
**T.C F7-319** 25.4 cm, 10"

**Kalt Needle Holders T.C**  
**T.C F7-320** 14 cm, 5 1/2" St.

**Mathieu-Ryder Needle Holders T.C**

**Mathieu-Ryder Vascular Needle Holders T.C**

**Corwin Needle Holders T.C**

**Lichtenberg Needle Holders T.C**

**Langenbeck Needle Holders T.C**

**Langenbeck-Delicate Needle Holders T.C**

**Langenbeck-Ryder Needle Holders T.C**

**Zweifel Needle Holders T.C**

**Eiselsberg-Mathei Needle Holders T.C**

**Luehly-Beck Needle Holders T.C**



**T F7-344**  
 TC-Coated jaws  
 Straight  
 11.5cm 4.5"

**Derf Needle Holder**  
 Ring Handle



**T F7-345**  
 TC-Coated jaws  
 Straight  
 11.5cm 4.5"

**Webster Needle Holder**  
 Ring Handle



**T F7-346**  
 TC-Coated jaws  
 Straight  
 13cm 5"

**Halsey Needle Holders**  
 Ring Handle



**T F7-347** 15cm 6"  
**T F7-348** 17cm 6.75"  
**T F7-349** 19cm 7.5"  
 Micro Jaws,  
 TC-Coated jaws  
 Straight

**Richards Micro  
 Needle Holders**  
 Ring Handle



**T F7-350** 15cm 6"  
**T F7-351** 17cm 6"  
**T F7-352** 19cm 7"  
 TC-Coated jaws  
 Straight

**Ryder Needle Holders**  
 Ring Handle



**T F7-353** 17.8cm 7"  
**T F7-354** 20.4cm 8"  
**T F7-355** 22cm 8 3/4"  
 Micro Jaws,  
 TC-Coated jaws  
 Straight

**Ultra-Micro Needle Holders**  
 Ring Handle



# TITANIUM NEEDLE HOLDERS

Nedelhaite | Porta-agujas  
Prote-aiquilles | Porta aghi



T F7-366 17.8cm 7"  
T F7-367 20.4cm 8"  
T F7-368 22cm 8 3/4"  
T F7-369 25cm 10"  
TC-Coated jaws  
Straight

**Intraaortic Needle Holder**  
Ring Handle



T F7-360 18cm 6 1/4"  
T F7-361 17.8cm 7"  
T F7-362 20.4cm 8"  
T F7-363 22cm 8 3/4"  
T F7-364 25cm 10"  
TC-Coated jaws  
Straight

**DeBakey Needle Holders**  
Ring Handle



T F7-365 17.8cm 7"  
T F7-366 20.4cm 8"  
T F7-367 22cm 8 3/4"  
T F7-368 25cm 10"  
Micro, jaws  
TC-Coated jaws  
w/lock  
Straight

**Microvascular Needle Holders**  
Ring Handle



T F7-369 16cm 6 1/4"  
T F7-370 17.8cm 7"  
T F7-371 20.4cm 8"  
T F7-372 22cm 8 3/4"  
2.8mm  
TC-Coated jaws  
Straight



T F7-373 16cm 6 1/4"  
T F7-374 17.8cm 7"  
T F7-375 20.4cm 8"  
T F7-376 22cm 8 3/4"  
2.8mm  
TC-Inserted jaws  
Straight

**Mayo-Hegar Needle Holders**  
Ring Handle



Heavy, TC-Coated jaws w/lock  
T F7-377 18.5cm 7.25"  
T F7-378 21cm 8.25"  
T F7-379 23cm 9.25"  
T F7-380 25cm 10"  
T F7-381 30cm 12"



Heavy, TC-Coated jaws w/lock  
T F7-382 10.5cm 7.25"  
T F7-383 21cm 8.25"  
T F7-384 23cm 9.25"  
T F7-385 25cm 10"

**Jacobson Heavy Needle Holders**  
Round Handle, Straight / Curved Jaws



Straight, Micro, TC-Coated  
T F7-386 jaws  
T F7-387 jaws w/lock



Curved, Micro  
TC-Coated  
T F7-388 jaws  
T F7-389 jaws w/lock

Round Bayonet Handle,  
Straight / Curved Up /  
Curved Down Jaws/Round  
Bayonet Handle,  
Straight / Curved Up /  
Curved Down Jaws

**Micro Needle Holders**  
W/Round Bayonet Handle 23.5cm 9.5"

**Reverdin Needle**  
 short

**F7-390**  
 14.5cm, 5 3/4"

**F7-391**  
 14.5cm, 5 3/4"

**F7-392**  
 14.5cm, 5 3/4"

**F7-393**  
 14.5cm, 5 3/4"

**Reverdin Needle**  
**F7-394-**  
**F7-397**  
 Small

**F7-394**  
 19.5cm, 7 1/4"  
**F7-393**  
 20cm, 8"

**F7-385**  
 19.5cm, 7 1/4"  
**F7-389**  
 20cm, 8"

**F7-386**  
 19.5cm, 7 1/4"  
**F7-400**  
 20cm, 8"

**F7-397**  
 19.5cm, 7 1/4"  
**F7-401**  
 20cm, 8"

**Reverdin Needle**  
**F7-398-**  
**F7-401**  
 Long





**Deschamps Needle**  
**F7-402** 20cm, 8"  
 sharp  
 for right hand

**F7-403** 20cm, 8"  
 sharp  
 for left hand



**Deschamps Needle**  
**F7-404** 20cm, 8"  
 blunt  
 for right hand

**F7-405** 20cm, 8"  
 blunt  
 for left hand



**Deschamps Needle**  
**F7-406** 21cm, 8 1/4"  
 blunt  
 for right hand

**F7-407** 21cm, 8 1/4"  
 blunt  
 for left hand

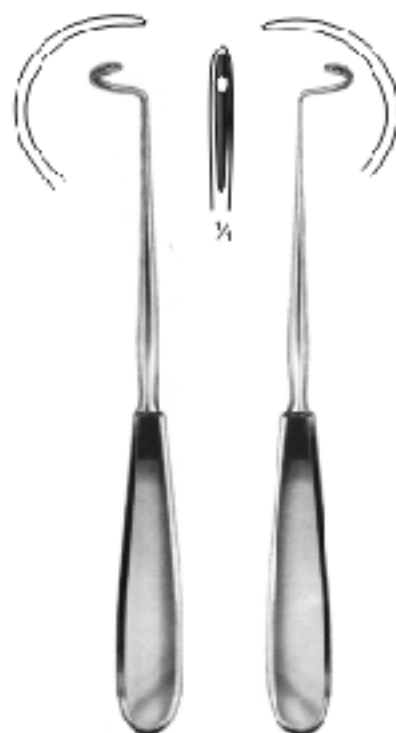

**Deschamps Needle**  
**F7-408** 20cm  
 blunt  
 for right hand

**F7-409** 20cm  
 blunt  
 for left hand



**Deschamps Needle**  
**F7-410** 20cm  
 sharp  
 for right hand

**F7-411** 20cm  
 sharp  
 for left hand

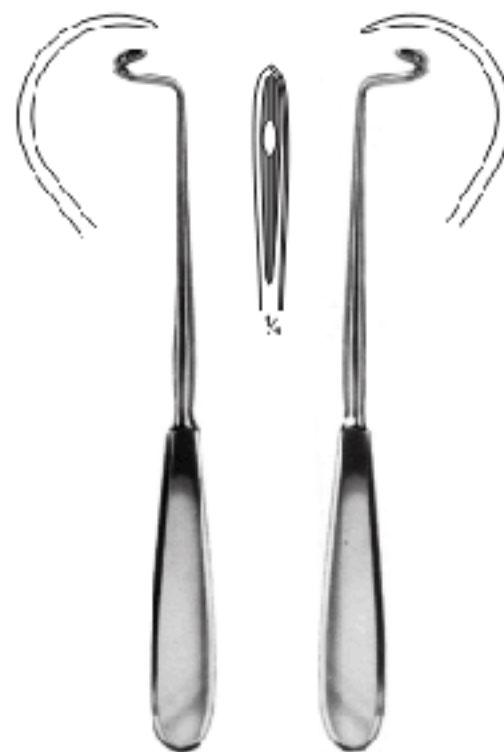

**Deschamps Needle**  
**F7-412** 20cm  
 blunt  
 for right hand

**F7-413** 20cm  
 blunt  
 for left hand

**Deschamps Needle**

<b>F7-414</b>	<b>F7-415</b>
20cm, 8"	20cm, 8"
sharp	sharp
for right	for left
hand	hand

**Deschamps Needle**

<b>F7-416</b>	<b>F7-417</b>
27cm, 10 3/4"	27cm, 10 3/4"
blunt	blunt
for right	for left
hand	hand

**Deschamps Needle**

<b>F7-418</b>	<b>F7-419</b>
27cm, 10 3/4"	27cm, 10 3/4"
sharp	sharp
for right	for left
hand	hand

**Deschamps Needle**

<b>F7-420</b>	<b>F7-421</b>
28cm, 11"	28cm, 11"
blunt	blunt
for right	for left
hand	hand

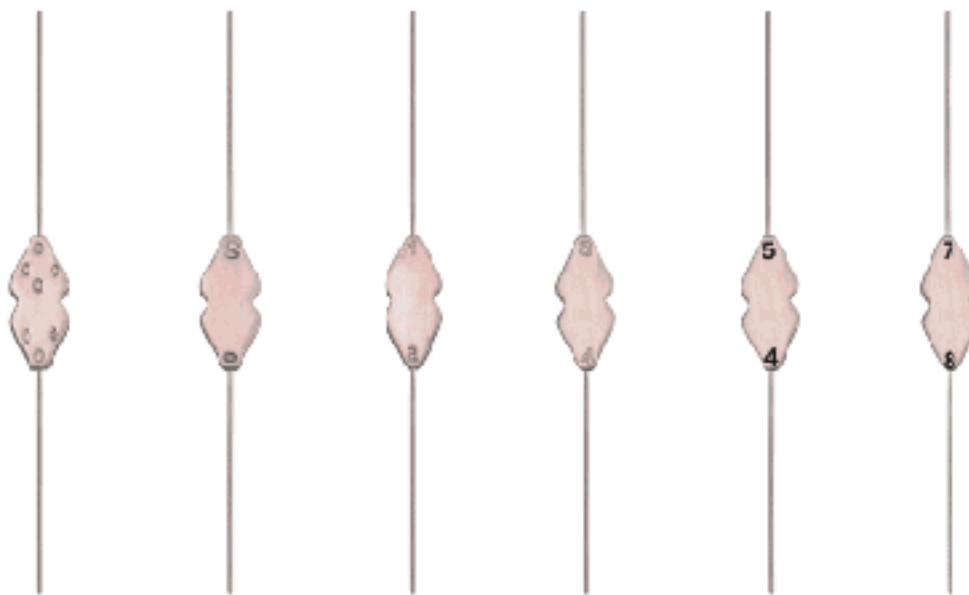
**BOWMAN LACRIMAL PROBES**  
 Double Ended, Sterling Silver

**F7-422**  
 Bowman Probe,  
 000-0000

**F7-423**  
 Bowman Probe,  
 00-0

**F7-424**  
 Bowman Probe,  
 1-2

**F7-425**  
 Bowman Probe,  
 3-4

**F7-426**  
 Bowman Probe,  
 5-6

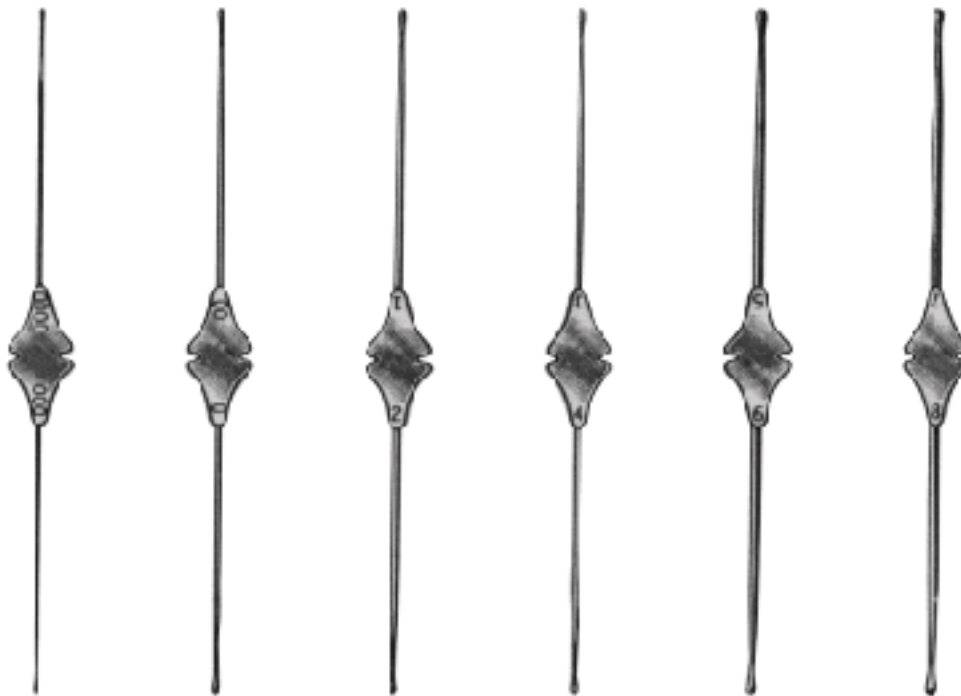
**F7-427**  
 Bowman Probe,  
 7-8

**WILLIAM LACRIMAL PROBES**  
 Double Ended, Sterling Silver

**F7-428**  
 William Probe,  
 000-0000

**F7-429**  
 William Probe,  
 00-0

**F7-430**  
 William Probe,  
 1-2

**F7-431**  
 William Probe,  
 3-4

**F7-432**  
 William Probe,  
 5-6

**F7-433**  
 William Probe,  
 7-8



**DIRECTORS**  
**F7-434** 13 cm, 5"  
**F7-435** 14.5 cm, 5 1/2"  
**F7-436** 16 cm, 6"  
**LARRY Probe and**  
**Grooved Director, 7" 17.8 cm**



**DOYEN**  
**F7-437**  
 14.6 cm, 5 3/4"



**NELATON**  
**F7-438**  
 16 cm, 6"



**DIRECTOR**  
**Probe End**  
**F7-439**  
 14 cm, 5 1/2"  
 Director with tip  
 Diam. Of tip 3.5 mm



**BRODIE**  
**F7-440**  
 20 cm, 8"  
 Director with tip  
 Diam. Of tip 3.5 mm



**LOCKHART-MUMMERY**  
**F7-441**  
 16.5 cm, 6 1/2"

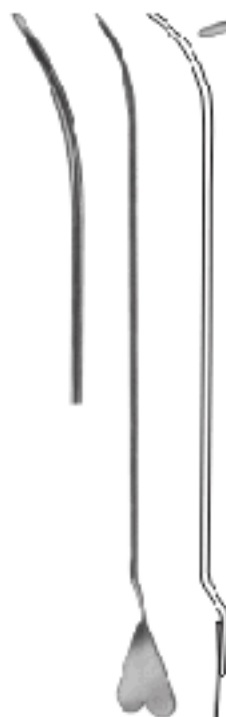

**LOCKHART-MUMMERY**  
**F7-442**  
 16.5 cm, 6 1/2"

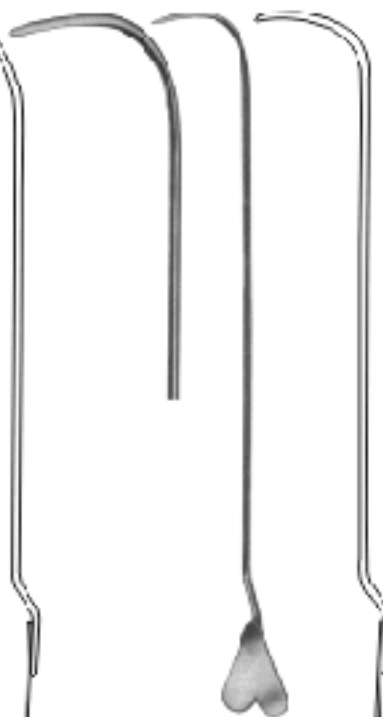

**LOCKHART-MUMMERY**  
**F7-443**  
 16.5 cm, 6 1/2"

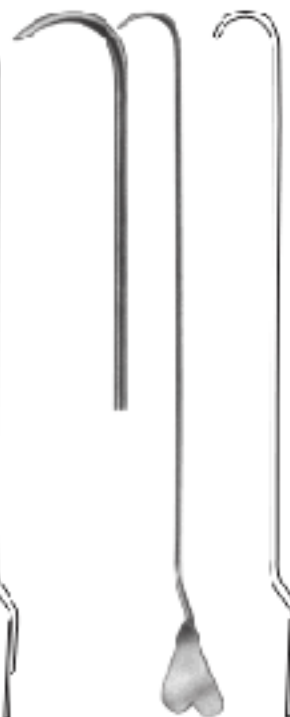

**LOCKHART-MUMMERY**  
**F7-444**  
 16.5 cm, 6 1/2"



**DIRECTOR**  
**with wire**  
**loop, malleable**  
**F7-445**  
 19 cm, 7 1/2"



**Probes With Eye**  
**F7-446** 14.5 cm, 5 3/4"  
**F7-447** 16.0 cm, 6 1/4"  
**F7-448** 20.0 cm, 8"



**Myrtle Leaf Probe**  
**F7-449**  
 14.5 cm, 5 3/4"



**Myrtle Leaf Probe**  
**F7-450** 13.0 cm, 5"  
**F7-451** 14.5 cm, 5 3/4"  
**F7-452** 16.0 cm, 6 1/4"  
**F7-453** 18.5 cm, 7"  
**F7-454** 20.0 cm, 8"



**Probe**  
**F7-455**



**WILDER Lacrimal Dilator,**  
**F7-456**  
 10.2 cm 4"  
 medium taper



**F7-457**  
 19.0 cm, 8 1/4"  
 Double ended probe,  
 malleable, diam. of tips  
 3 mm with hole



**F7-458** 25.0 cm, 10"  
**F7-459** 30.0 cm, 12"  
 Double ended probes,  
 tin, malleable, diam. of tips  
 3.5 mm with hole



**F7-460**  
 40.0 cm, 15 3/4"  
 Double ended probes,  
 tin, malleable, diam. of tips  
 4 mm with hole



**F7-461** 1.5 mm  
**F7-462** 2.0 mm  
**F7-463** 2.5 mm  
 30.0 cm, 12"



**STACKE**  
**F7-464**  
 13.0 cm, 4"



**KILLIAN**  
**F7-465**  
 16.5 cm, 6 1/2"



**F7-466**  
 16.5 cm, 6 1/2"



**SEIFFERT**  
**F7-467**  
 18.1 cm, 7"



**SPATULA**  
**F7-468**  
 14.5 cm, 5 3/4"



**SPATULA**  
**F7-469**  
 14.5 cm, 5 3/4"



**MODELL PICCOLO**  
**F7-470**  
 11.0 cm, 4 1/4"  
 Round Serrated



**MODELL PICCOLO**  
**F7-471** 11.0 cm, 4 1/4"  
 Triangular Serrated end



**FARRELL**  
**F7-472**  
 11.0 cm, 4 1/4"  
 Round Serrated end



**LATHBURY-FARRELL**  
**F7-473**  
 11.0 cm, 4 1/4"  
 Triangular Serrated end



## RETRACTORS

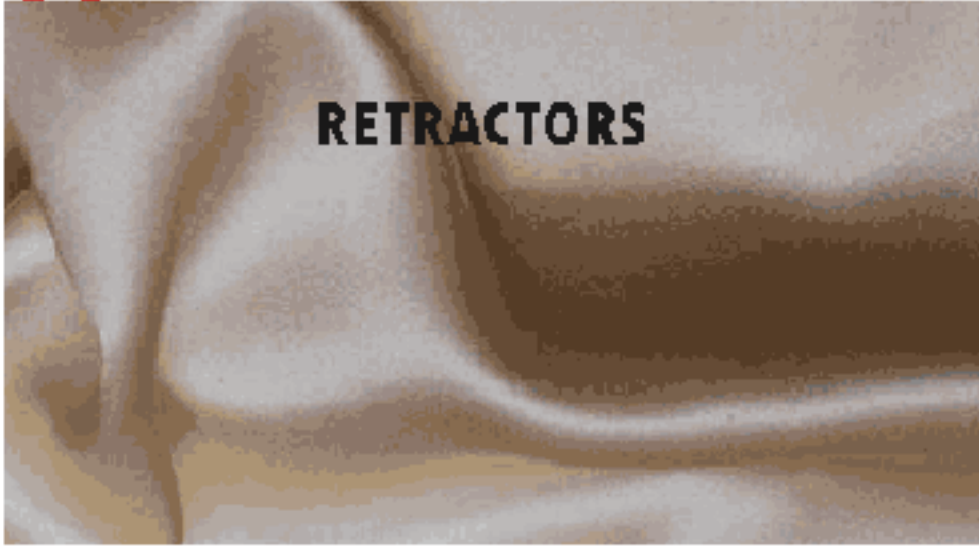

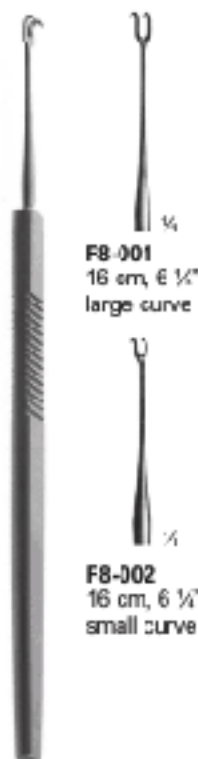

**FB-001**  
16 cm, 6 1/4"  
large curve

**FB-002**  
16 cm, 6 1/4"  
small curve

**GUTHRIE HOOKLET**



**FB-003**  
10 cm, 7"  
Sharp

**FB-004**  
13 cm 7"  
snap

**GILLIES SKIN HOOK**



**FB-005**  
15 cm, 6"  
sharp

**KILNER HOOK**

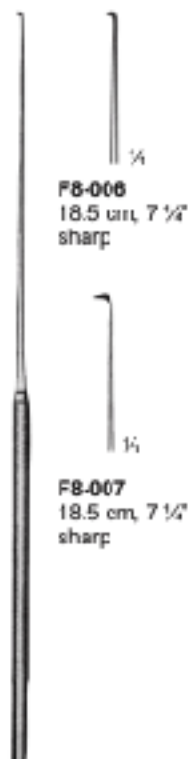

**FB-006**  
18.5 cm, 7 1/2"  
sharp

**FB-007**  
18.5 cm, 7 1/2"  
sharp

**FISCH HOOKLET & Skin Hook**



**FB-008**  
13 cm, 5"  
**FB-009**  
18 cm, 7"  
Blunt

**FB-010**  
13 cm, 5"  
**FB-011**  
18 cm, 7"  
Sharp

**FRAZIER HOOKLET & Skin Hook**



**DOUBLE PRONG MICRO HOOK & Skin Hook**  
**FB-012**  
Sharp, 2mm, wide jaws,  
14.5 cm, 6 1/4"



**WIENER HOOK & Skin Hook**  
**FB-013**  
Sharp,  
14 cm, 5 1/2"



**TOENNIS HOOK & Skin Hook**  
**FB-014**  
15 cm, 6"  
Sharp



**FB-015**  
2 sharp prong  
13 cm, 5"  
2.25mm diameter  
3mm wide

**FB-016**  
4 sharp prong  
13 cm, 5"  
2mm diameter  
5mm wide

**FB-017**  
4 blunt prong  
13 cm, 5"  
2mm diameter  
5mm wide

**ROLLET HOOK**



**FB-018**  
15 cm, 6", sharp  
double prongs  
2.5mm wide

**FB-019**  
15 cm, 6" blunt  
double prongs  
2.5mm wide

**FREER SKIN HOOK**





**CRILE HOOKLET  
& SKIN HOOKS**  
F8-020 20.4 cm, 8"



**VON GRAEFE Strabismus  
& SKIN HOOKS**  
F8-021 13.0 cm, 5" -A  
F8-022 14.0 cm, 5 1/2" -B  
F8-023 15.0 cm, 6" -C



**WAGENER HOOKLET  
& SKIN HOOKS**  
F8-024 14 cm, 5 1/2" -A  
F8-025 14 cm, 5 1/2" -B  
F8-026 14 cm, 5 1/2" -C  
F8-027 14 cm, 5 1/2" -D



**DAY HOOKLET  
& SKIN HOOKS**  
F8-028 16 cm, 6 1/4" -A  
F8-029 16 cm, 6 1/4" -B



**LUCAE HOOKLET  
& SKIN HOOKS**  
F8-030 14 cm, 5 1/2" -A  
F8-031 14 cm, 5 1/2" -B  
F8-032 14 cm, 5 1/2" -C



**Converse Hook**  
F8-033  
17 cm, 5"



**MANNERFELT-LANGENBECK HOOK**  
F8-034 15 x 6 mm 15.5 cm, 6" Fig.1  
F8-035 20 x 6 mm 15.5 cm, 6" Fig.2  
F8-036 25 x 6 mm 15.5 cm, 6" Fig.3  
F8-037 30 x 8 mm 15.5 cm, 6" Fig.4

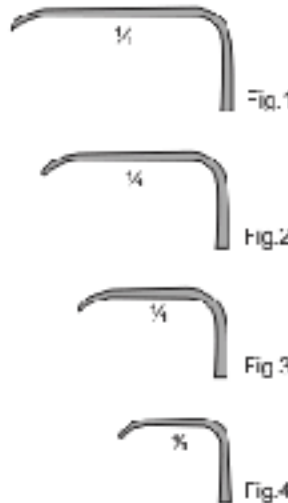

**MANNERFELT HOOK**  
15.5 cm, 6"  
large curve, single  
hook





**Tracheal Retractor**  
18 cm, 7"

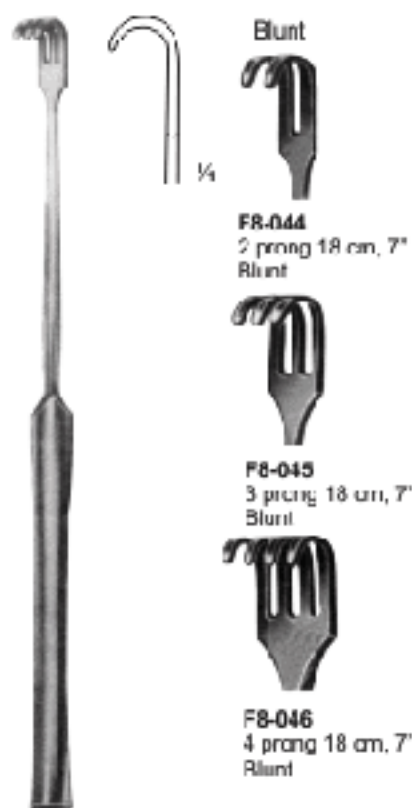

**Tracheal Retractor**  
18 cm, 7"

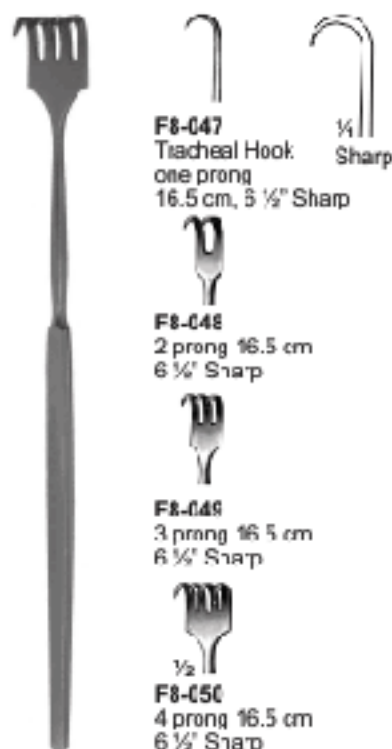

**Trachea Retractor**  
16.5 cm, 6 1/2"  
Sharp

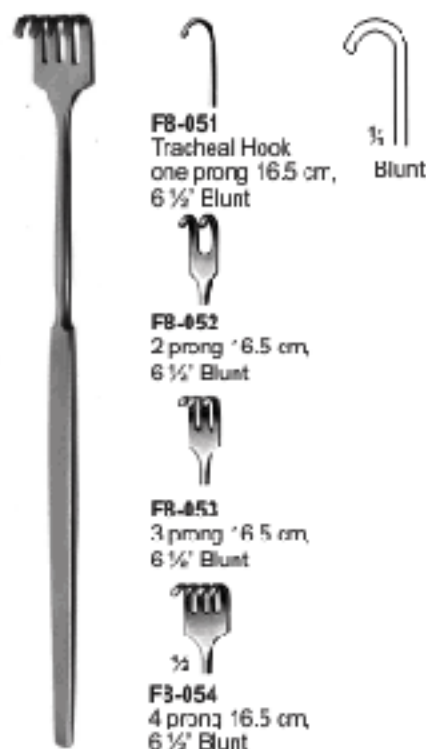

**Tracheal Retractor**  
16.5 cm, 6 1/2"  
Blunt

*Windhäkchen, Windhaken*  
*Gonchita, Separadores*

*Crochet, Farteus*  
*Divaricatore, Divaricatori*



**Rollet Hooklet Retractors**  
F8-055  
12.5 cm, 4 3/4"



**Rollet (Blair) Hooklet Retractors**  
F8-056  
13.5 cm, 5"



**Paul Hooklet Retractors**  
F8-057  
12.5 cm, 4 3/4"



**Paul Hooklet Retractors**  
F8-058  
16 cm, 6 1/4"



**Miller Retractor**  
F8-059  
13.5 cm, 5 1/4"  
Sharp 6 prong



**Miller Retractor**

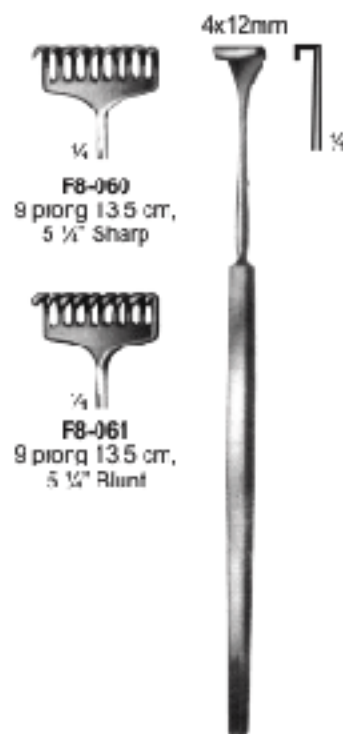

**Hooklet Retractors**  
F8-062  
13 cm, 5"



**Brom Hooklet Retractors**  
F8-063  
17 cm, 6 3/4"

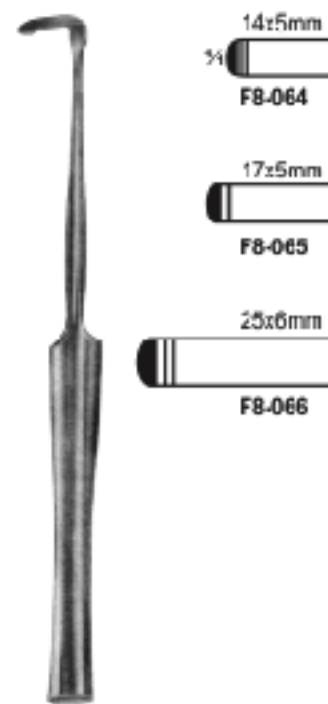

**Hooklet Retractors**  
17 cm, 6 3/4"



Sharp



**F8-067**  
one prong  
Sharp



**F8-068**  
two prong  
Sharp



**F8-069**  
three prong  
Sharp



**F8-070**  
four prong  
Sharp

**Finger Rake, Retractor**  
15.5 cm, 6 1/8"



Blunt



**F8-071**  
one prong  
Blunt



**F8-072**  
two prong  
Blunt



**F8-073**  
three prong  
Blunt



**F8-074**  
four prong  
Blunt

**Finger Rake, Retractor**  
16.5 cm, 6 1/2"



**F8-075**  
2 prong  
flexible, sharp



**F8-078**  
2 prong  
flexible, blunt



**F8-076**  
3 prong  
flexible, sharp



**F8-079**  
3 prong  
flexible, blunt



**F8-077**  
4 prong  
flexible, sharp



**F8-080**  
4 prong  
flexible, blunt

**Hooklets, Retractors**  
16 cm, 5 3/4"



**F8-081**  
4 prong  
flexible sharp



**F8-082**  
4 prong  
flexible blunt

**Peck Rake Retractor**  
16.5 cm, 6 1/2"



**Kocher Hooklet,  
Retractors**  
**F8-003**  
 21 cm, 8 1/4"  
 Sharp



**Kocher Hooklet,  
Retractors**  
**F8-004**  
 21 cm, 8 1/4"  
 Blunt



**Kocher Hooklet,  
Retractors**  
**F8-005**  
 22 cm, 8 3/4"  
 Sharp



**Kocher Hooklet,  
Retractors**  
**F8-006**  
 22 cm, 8 3/4"  
 Blunt



**Hooklet,  
Retractors**  
**F8-007**  
 24.5 cm, 9 3/4"  
 Sharp



**Hooklet,  
Retractors**  
**F8-008**  
 20 cm, 8"  
 Sharp



**Hooklet,  
Retractors**  
**F8-009**  
 20 cm, 8"  
 Blunt

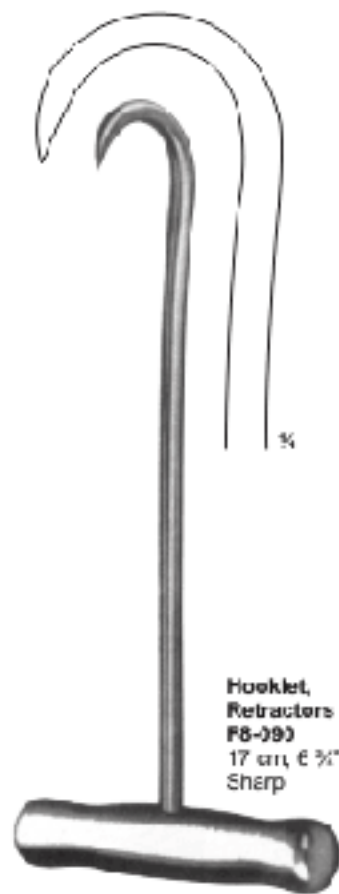

**Hooklet,  
Retractors**  
**F8-090**  
 17 cm, 6 3/4"  
 Sharp



**Volkman Retractors**  
**F8-091**  
 23 cm, 9"  
 Sharp



**Volkman Retractors**  
**F8-092**  
 23 cm, 9"  
 Dull



**Lambotte Retractors**  
 20 cm 18"  
**F8-093**  
 13 x 236 mm  
**F8-094**  
 20 x 266 mm  
**F8-096**  
 27 x 270 mm



**Volkman Retractors**  
 11.5 cm, 4 1/2"

Sharp



**F8-096**  
 2 prong

Dull



**F8-100**  
 2 prong



**F8-097**  
 3 prong



**F8-101**  
 3 prong



**F8-098**  
 4 prong



**F8-102**  
 4 prong



**F8-099**  
 6 prong



**F8-103**  
 6 prong



**Murphy Retractors**  
 16.1 cm 7 1/2"  
**F8-104** 3 prongs  
**F8-105** 3 prongs  
**F8-106** 4 prongs  
**F8-107** 4 prongs  
 Sharp



**Senn Retractor**  
F8-108  
16 cm 6 1/4"  
Blunt



**Senn Retractor**  
F8-109  
16 cm 5 3/4"  
Sharp



**Senn-Mueller Retractor**  
F8-110  
18 x 6 mm  
16 cm, 6 1/4"  
sharp



**Volkman Retractor**  
F8-111  
22 cm 8 3/4"  
4 Prongs Sharp



**Volkman Retractor**  
F8-112  
22 cm 8 3/4"  
4 Prongs Blunt



**Sternberg Retractor**  
F8-113 12 cm, 4 3/4"  
F8-114 14 cm, 5 1/2"  
F8-115 16 cm, 6 1/4"



**Collin-Hartmann Retractor**  
FR-116  
33 x 28 / 32 x 21 mm 14 cm, 5 1/2"  
FR-117  
52 x 34 / 36 x 27 mm 16 cm, 6 1/4"



**Herzfeld Retractor**  
**F8-118**  
 20 cm, 8"



**Strandell-Stillé Retractor**  
**F8-119**  
 16 cm, 7 1/2"



**Strandell-Stillé Retractor**  
**F8-120**  
 10 cm, 7 1/2"

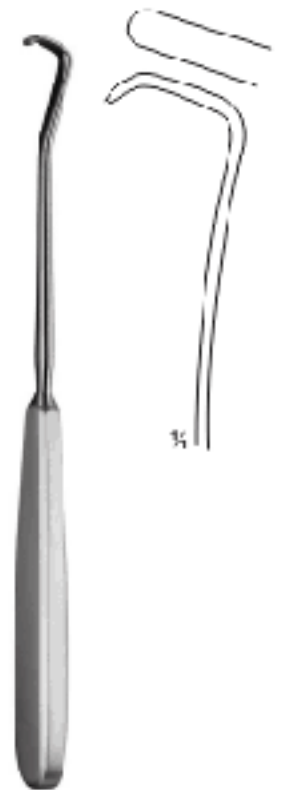

**Schoenborn Retractor**  
**F8-121**  
 21 cm, 8 1/4"



**König Retractor**  
 17 cm, 6 3/4"



**F8-122**  
 13 x 13 mm

**F8-123**  
 12 x 16 mm



**Sera-Green Retractor**  
 16 cm, 6"



**F8-124**  
 10 x 6 mm

**F8-125**  
 20 x 6 mm



**Cottle Retractor**  
**F8-126**  
 16 cm, 6"  
 10 x 12 mm



**Ragnell-Davis Retractor**  
**F8-127**  
 14 cm, 5 1/2"  
**F8-128**  
 8 x 4 mm  
**F8-128**  
 16 x 5.5 mm



*Windhäkchen*  
*Gonchito*
*Crochet*  
*D'auricolare*

 Fig.1  
**F8-129**  
 12 x 12 mm

 Fig.2  
**F8-130**  
 12 x 14 mm

 Fig.3  
**F8-131**  
 12 x 10 mm

**Mannert Hooklet Retractors**  
 15.5 cm, 6"

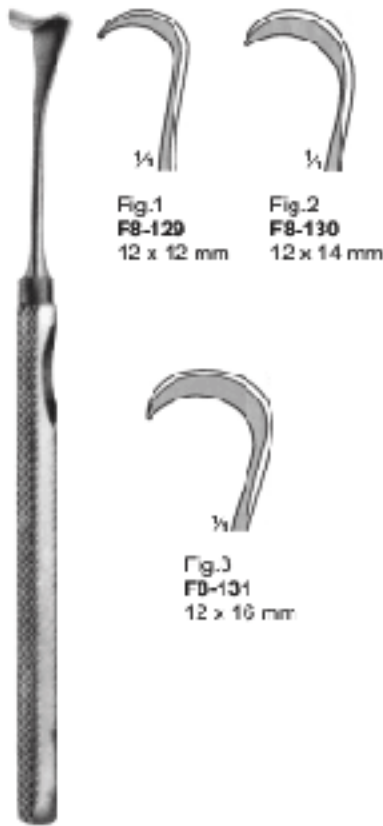
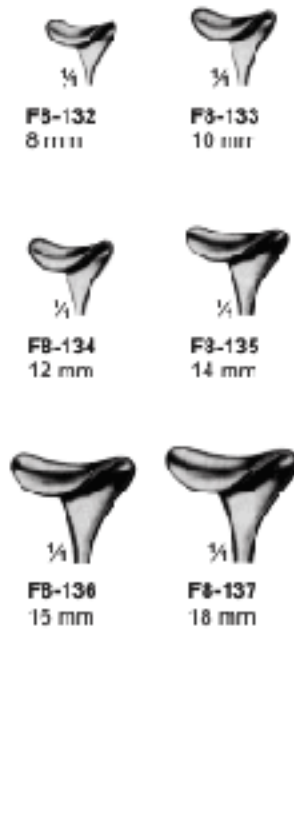
**Cushing Hooklet Retractors**  
 20 cm, 8"

**F8-132**  
 8 mm

**F8-133**  
 10 mm

**F8-134**  
 12 mm

**F8-135**  
 14 mm

**F8-136**  
 15 mm

**F8-137**  
 18 mm

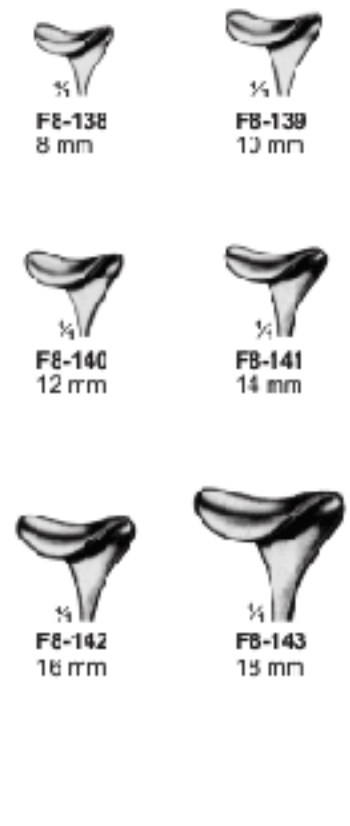
**Cushing Hooklet Retractors**  
 24 cm, 9 1/2"

**F8-138**  
 8 mm

**F8-139**  
 13 mm

**F8-140**  
 12 mm

**F8-141**  
 14 mm

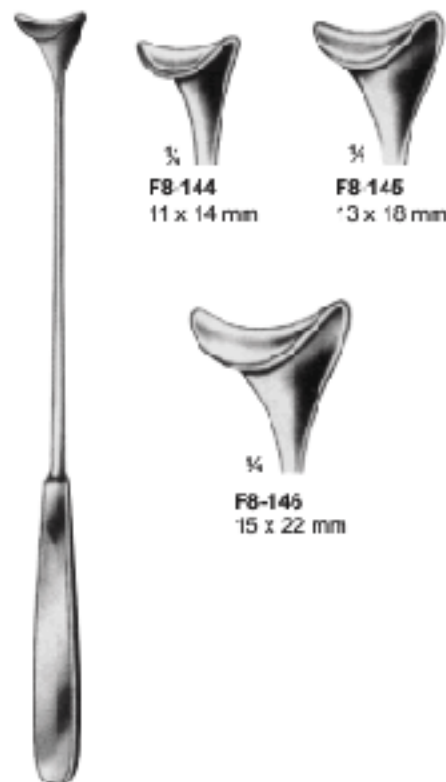
**F8-142**  
 16 mm

**F8-143**  
 15 mm

**F8-144**  
 11 x 14 mm

**F8-145**  
 13 x 18 mm

**F8-146**  
 15 x 22 mm

**Cushing Hooklet Retractors**  
 24 cm, 9 1/2"

**F8-147**  
 10 x 10 mm

**F8-148**  
 7 x 8 mm

**F8-149**  
 9 x 10 mm

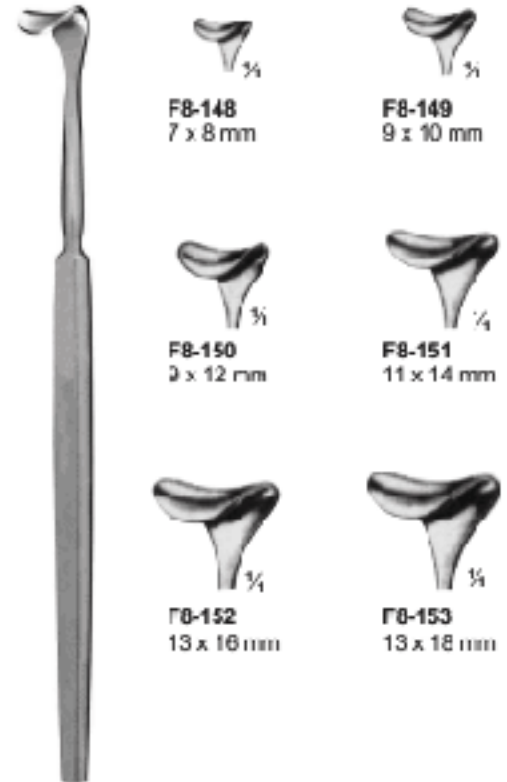
**Cushing-Kocher Hooklet Retractors**  
 18 cm, 7"

**F8-150**  
 9 x 12 mm

**F8-151**  
 11 x 14 mm

**F8-152**  
 13 x 16 mm

**F8-153**  
 13 x 18 mm

**Desmarres Lid Retractors**  
 16 cm, 6 1/4"



**Kocher Retractor**  
28 cm 11"

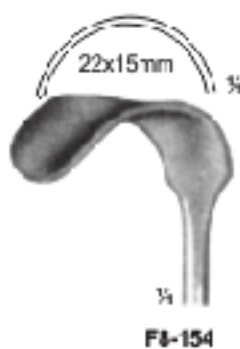

**F8-154**



**F8-155**

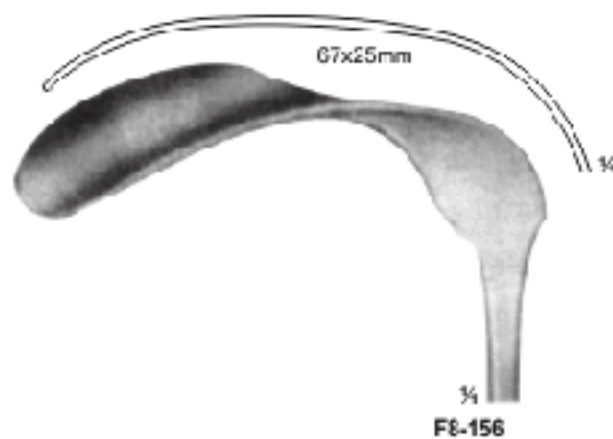

**F8-156**

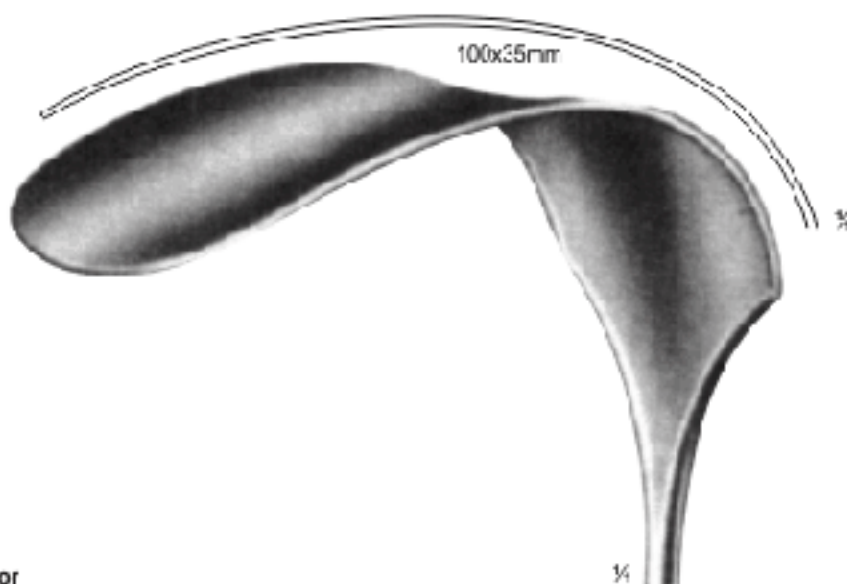

**F8-157**

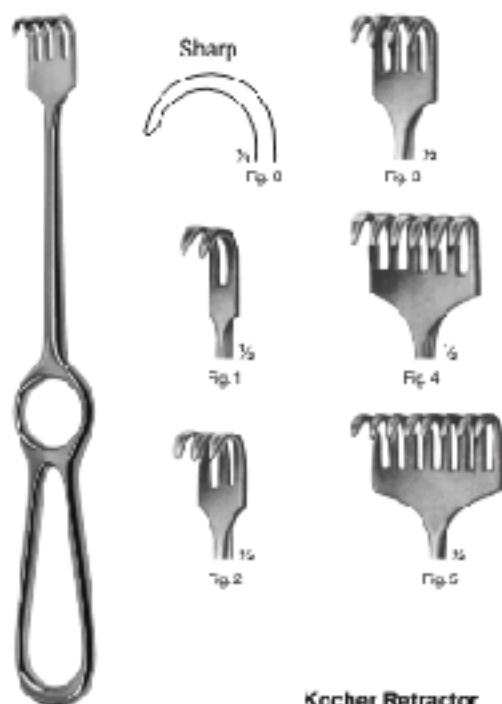
**Kocher Retractor**

- F8-158 22 cm, 8 3/8" 15 x 10 mm 2 prong Fig. 1  
 F8-159 22 cm, 8 3/8" 15 x 15 mm 3 prong Fig. 2  
 F8-160 22 cm, 8 3/8" 15 x 20 mm 4 prong Fig. 3  
 F8-161 22 cm, 8 3/8" 15 x 30 mm 6 prong Fig. 4  
 F8-162 22 cm, 8 3/8" 15 x 40 mm 8 prong Fig. 5

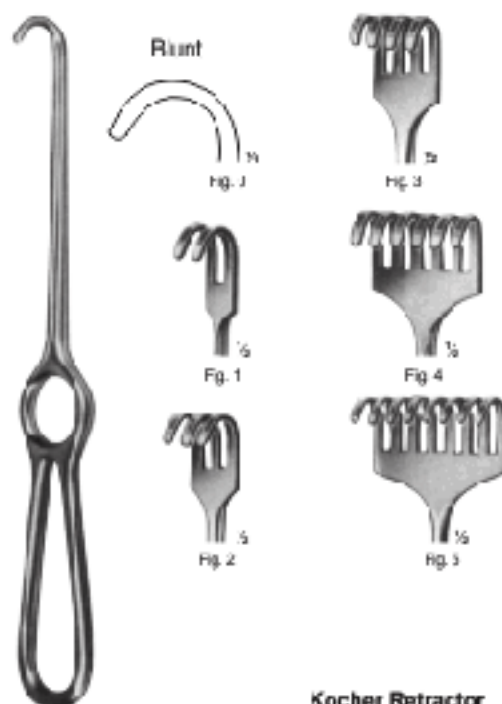
**Kocher Retractor**

- F8-163 22 cm, 8 3/8" 15 x 10 mm 2 prong Fig. 1  
 F8-164 22 cm, 8 3/8" 15 x 15 mm 3 prong Fig. 2  
 F8-165 22 cm, 8 3/8" 15 x 20 mm 4 prong Fig. 3  
 F8-166 22 cm, 8 3/8" 15 x 30 mm 6 prong Fig. 4  
 F8-167 22 cm, 8 3/8" 15 x 40 mm 8 prong Fig. 5

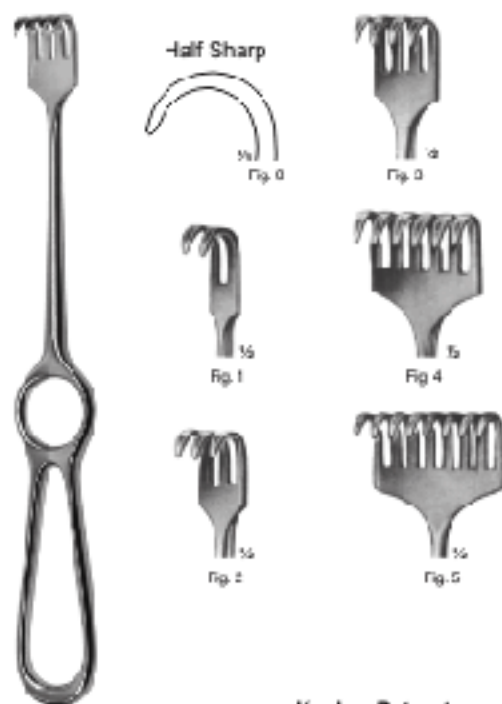
**Kocher Retractor**

- F8-168 22 cm, 8 3/8" 15 x 10 mm 2 prong Fig. 1  
 F8-169 22 cm, 8 3/8" 15 x 15 mm 3 prong Fig. 2  
 F8-170 22 cm, 8 3/8" 15 x 20 mm 4 prong Fig. 3  
 F8-171 22 cm, 8 3/8" 15 x 30 mm 6 prong Fig. 4  
 F8-172 22 cm, 8 3/8" 15 x 40 mm 8 prong Fig. 5

**Kocher Retractor**  
 13 cm, 7 1/8"



**Kocher-Langenbeck  
Retractor**  
21.5 cm, 8 1/2"



**F8-173**  
25 x 6 mm



**F8-176**  
36 x 8 mm



**F8-177**  
35 x 11 mm



**F8-178**  
35 x 15 mm

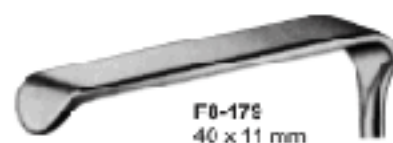

**F8-179**  
40 x 11 mm

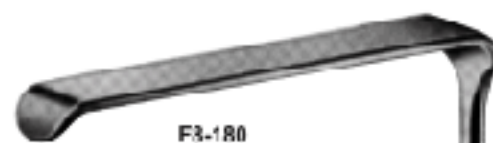

**F8-180**  
55 x 11 mm



**F8-181**  
70 x 14 mm

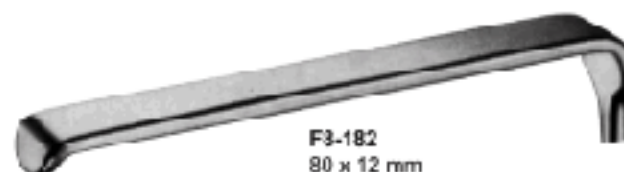

**F8-182**  
80 x 12 mm

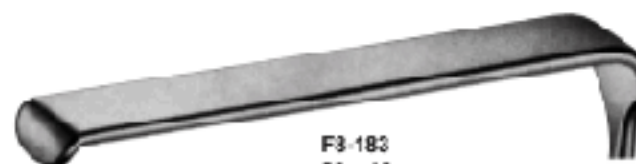

**F8-183**  
80 x 16 mm

**Kocher Retractor**  
 23 cm, 9"

**F8-184**  
 40 x 18 mm

**F8-185**  
 30 x 20 mm

**F8-186**  
 50 x 25 mm

**F8-187**  
 75 x 30 mm

**F8-188**  
 75 x 40 mm

**Kocher Retractor**  
 22 cm, 3 1/2"  
**F8-189** 40 x 10 mm  
**F8-190** 40 x 15 mm  
**F8-191** 40 x 20 mm

**Kocher Retractor**  
**F8-192**  
 22.5 cm 0 3/4"  
 70 x 25 mm

**Kocher Retractor**  
**F8-193** 23 cm, 9" 35 x 18 mm  
**F8-194** 23 cm, 9" 60 x 20 mm  
**F8-195** 23 cm, 9" 60 x 25 mm  
**F8-196** 23 cm, 9" 75 x 30 mm  
**F8-197** 23 cm, 9" 75 x 40 mm

**Kocher Retractor**  
**F8-198** 25 cm, 9 1/2" 80 x 45 mm  
**F8-199** 25 cm, 9 1/2" 80 x 55 mm  
**F8-200** 25 cm, 9 1/2" 80 x 65 mm

**Kocher-Wagner Retractor**  
 28 cm, 11"

**F8-201**  
 22 x 15 mm

**F8-202**  
 38 x 20 mm

**F8-203**  
 67 x 25 mm



**Langenbeck Retractor  
F0-204**  
21.5 cm 8 1/2"  
Handle vertical  
to the blade



**Langenbeck  
Retractor  
F0-206**  
20.4 cm 8"



**F0-205**  
20 x 7 mm



**F0-206**  
30 x 7 mm



**F0-207**  
30 x 11 mm



**F0-208**  
30 x 15 mm



**F0-209**  
30 x 20 mm



**F0-210**  
44 x 10 mm



**F0-211**  
44 x 15 mm



**F0-212**  
45 x 20 mm



**F0-213**  
50 x 20 mm



**F0-214**  
60 x 20 mm



**Langenbeck Retractor  
F0-215**  
21 cm 8 1/8"  
36 x 9mm



**Langenbeck Retractor  
F0-216**  
24 cm, 8 1/4"



**F0-216**  
35 x 7mm



**F0-217**  
35 x 11mm



**F0-218**  
35 x 15mm

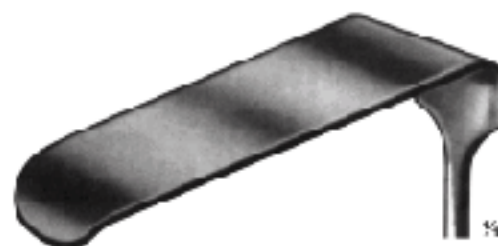

**F0-219**  
35 x 20mm



**Langenbeck Retractor**  
22 cm, 8 1/4"



**F3-220**  
25 x 6 mm



**F3-221**  
35 x 8 mm



**F3-222**  
35 x 11 mm



**F3-223**  
35 x 15 mm



**F3-224**  
41 x 11 mm



**F3-225**  
55 x 11 mm



**F3-226**  
70 x 14 mm



**Langenbeck Retractor**  
22 cm, 8 1/4"



**F8-227**  
25 x 6 mm



**F8-228**  
35 x 6 mm



**F8-229**  
35 x 11 mm



**F8-230**  
35 x 15 mm



**F8-231**  
41 x 11 mm



**F8-232**  
55 x 11 mm

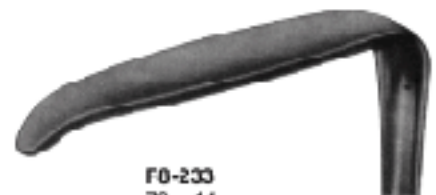

**F8-233**  
70 x 14 mm

**F8-214**  
 14 x 17 mm

**F8-215**  
 20 x 22 mm

**F8-216**  
 26 x 30 mm

**Middeldorpf Retractor**  
 21 cm, 8 1/4"

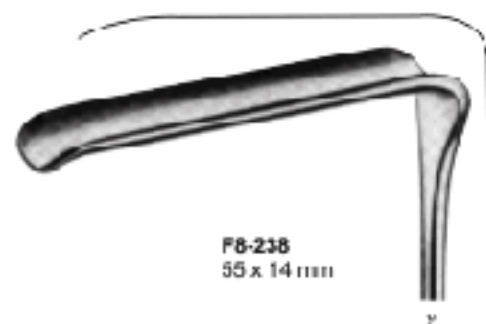
**F8-237**  
 40 x 12 mm

**F8-238**  
 55 x 14 mm

**Casper Retractor**  
 21 cm, 8 1/4"

25 mm

**Ollier Retractor**  
**F8-239**  
 8.5 cm, 7 1/4"

**Lahey Gelter Retractor**  
**F8-240** 20.4 cm, 8"  
 Right angle blade, length  
 1 inch (2.5cm). With lip.

28x6 mm

**Lahey Retractor**  
**F8-241**  
 19 cm, 7 1/2"





**Tendin Hooks Retractor**  
**F8-242** 12 x 6 mm Fig. 1  
**F8-243** 12 x 11 mm Fig. 2  
 17.5 cm, 7"



**Klapp Retractor**  
**F8-244**  
 17.5 cm, 7"  
 15 x 11 mm



**Little Retractor**  
**F8-245**  
 20 cm, 8"  
 12x14 mm



**Wassmund Retractor**  
**F8-246**  
 20 cm, 3"  
 33 x 20mm



**Meyerding Finger Retractor**  
**F8-247**  
 18 cm, 7"



**F8-247**  
 long blunt blade,  
 1/4" x 11/16"  
 6 x 17 mm Blunt



**F8-250**  
 long toothed base,  
 3/16" x 5/8"  
 5 x 16mm



**F8-248**  
 short toothed blade  
 1/8" x 1/4"  
 3 x 6 mm



**F8-251**  
 short blunt blade  
 1/8" x 3/8"  
 3 x 10mm



**F8-249**  
 curved blunt blade,  
 1/8" x 3/8"  
 3 x 8mm  
 Saddle Shaped



**F8-252**  
 curved three prong  
 sharp blade,  
 3/32" x 5/32"  
 10 x 4mm



**Blount Knee Retractor**  
**F8-253**  
 17.5 cm, 6 3/4"  
 42 x 4 mm



**Taylor Spinal Retractors**  
**F8-254** 16.5 cm, 6 1/2"  
 75 x 30 mm / 100 x 30 mm



**Luer Retractor**  
**F8-255** 11 cm, 4 1/4"  
 10 x 8 mm / 12 x 11 mm



**Rose Retractor**  
**F8-256** 13 cm, 5"  
 12 x 12 mm /  
 12 x 15 mm



**Crile Retractor**  
**F8-257** 11 cm, 4 1/4"  
 12 x 4 mm /  
 20 x 6 mm



**Mathieu Retractor**  
 Set 2 pcs.  
**F8-258** 20 cm, 8"  
 47 x 13 / 48 x 23 mm  
**F8-259** 20 cm, 8"  
 42 x 13 / 42 x 23 mm



**Us-Army Retractor**  
 Set 2 pcs.  
**F8-260** 21.5 cm, 8 1/2"  
 28 x 15 / 42 x 15 mm  
**F8-261** 21.5 cm, 8 1/2"  
 25 x 15 / 38 x 15 mm



**Richardson Eastman Retractor**  
**F8-262**  
 26 cm, 10 1/4"  
 small



**Richardson Eastman Retractor**  
**F8-263**  
 28 cm, 11"



**Sofield Retractor**  
**F8-264**  
 set of 6 pcs.

**Roux Retractor**  
 Set 3 pcs. consisting of  
 #1 F8-265 14 cm 5 1/2" 24 x 20 | 30 x 28 mm  
 #2 F8-266 15 cm 6" 29 x 26 | 38 x 36 mm  
 #3 F8-267 17 cm 6 3/4" 33 x 29 | 38 x 43 mm

**Baby-Roux Retractor**  
 F8-268 13 cm, 5"  
 15 x 15 mm/  
 18 x 21 mm

**Roux Retractor**  
 F8-259 16.5 cm, 6 1/2"  
 28 x 23 mm/  
 43 x 23 mm

**Roux Retractor**  
 F8-270 18.5 cm, 7 1/4"  
 28 x 27 mm/  
 45 x 27 mm

**Mini-Roux Retractor**  
 F8-271  
 14 cm, 5 1/2"

**Roux-Magnus Retractor**  
 F8-272 15 cm, 6"  
 20 x 22 mm/  
 25 x 33 mm

**Roux-Magnus Retractor**  
 F8-273 16 cm, 6 1/4"  
 23 x 28 mm/  
 29 x 33 mm

**Roux-Magnus Retractor**  
 F8-274 17 cm, 6 3/4"  
 29 x 29 mm/  
 34 x 44 mm



**Farabeuf Retractor**  
 Set 2 Pcs.  
**FB-275** 13 cm, 5"  
 33 x 10 / 34 x 13 mm  
**FB-276** 13 cm, 5"  
 25 x 10 / 30 x 13 mm



**Farabeuf Retractor**  
 Set 2 Pcs.  
**FB-277** 15 cm, 6"  
 27 x 16 / 30 x 16 mm  
**FB-278** 15 cm, 6"  
 23 x 16 / 25 x 16 mm



**Parker Retractor**  
 Set 2 pcs.  
**FB-279** 13.5 cm, 5 1/2"  
 22 x 15 mm / 22 x 15 mm  
**FB-280**  
 18.4 cm 7 1/4"



**Parker Retractor**  
**FB-281** 13.5 cm, 5 1/2"  
 18 x 15 mm / 19 x 15 mm

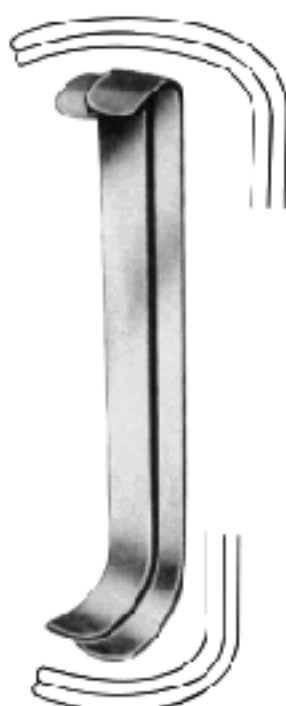

**Collin Retractor**  
 Set 2 pcs.  
**FB-282** 16.5 cm, 5 1/2"  
 25 x 12 / 35 x 16 mm  
**FB-283** 16.5 cm, 5 1/2"  
 20 x 12 / 30 x 16 mm



**Mayo-Collin Retractor**  
 Set 2 pcs.  
**FB-284** 15 cm, 6"  
 28 x 18 / 25 x 18 mm



**Parker-Langenbeck Retractor**  
 Set of 2 Pcs.  
**FB-285** 21.5 cm, 8 1/2" 25 x 15 mm fig. 2  
**FB-286** 21.5 cm, 8 1/2" 21 x 15 mm fig. 1  
**FB-287** 21.5 cm, 8 1/2" 40 x 15 mm fig. 1  
**FB-288** 21.5 cm, 8 1/2" 46 x 15 mm fig. 2



**Parker-Mott Retractor**  
**FB-289**  
 16 cm 6 1/4"  
 68 x 24 / 74 x 24 mm



- F8-290**  
Blunt, 2 prongs.
- F8-291**  
Blunt, 3 prongs.
- F8-292**  
Blunt, 4 prongs.
- F8-293**  
Blunt, 5 prongs.
- F8-294**  
Blunt, 6 prongs.
- F8-295**  
Sharp, 2 prongs.
- F8-296**  
Sharp, 3 prongs.
- F8-297**  
Sharp, 4 prongs.
- F8-298**  
Sharp, 5 prongs.
- F8-299**  
Sharp, 6 prongs.

**Volkman Retractors**  
 Long Pattern  
 22.2 cm, 8 1/4"



**Koerte Retractor**  
**F8-301** 24 cm, 9 1/2"  
 26 x 40 mm  
 sharp

**Koerte Retractor**  
**F8-300** 24 cm, 9 1/2"  
 26 x 40 mm  
 blunt



**Koerte Retractor**  
**F8-302** 23 cm 9"  
 48 x 55 mm  
 blunt



**Koerte Retractor**  
**F8-303** 28 cm, 11"  
 25 x 40 mm  
 semi-sharp



**Koerte Retractor**  
**F8-304** 23 cm, 9"  
 Blunt



**Korte-Wagner Retractor**  
**F8-305** 28 cm, 11"  
 Sharp

**F8-306**  
 115 x 85 mm

**Coryllos Retractor**  
 22.5 cm, 3 3/4"

**F8-307**  
 115 x 38 mm

**F8-308**  
 82 x 22 mm

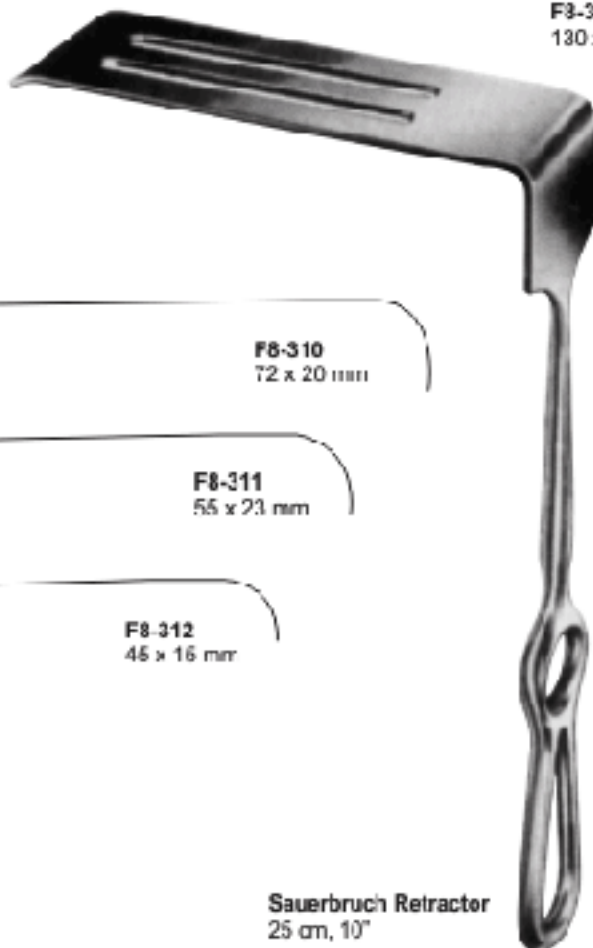
**F8-309**  
 130 x 38 mm

**Sauerbruch Retractor**  
 25 cm, 10"

**F8-310**  
 72 x 20 mm

**F8-311**  
 55 x 23 mm

**F8-312**  
 45 x 16 mm

**Davidson Retractor**  
**F8-313** 16 cm, 6 1/4" 75 x 50 mm  
**F8-314** 16 cm, 6 1/4" 75 x 90 mm

**FB-316**  
130 x 30 mm

**FB-316**  
150 x 30 mm

**FB-317**  
140 x 30 mm

**FB-318**  
130 x 30 mm

**FB-319**  
120 x 25 mm

**FB-320**  
100 x 25 mm

**FB-321**  
80 x 20 mm



**Bruner Retractor**  
25 cm, 10"

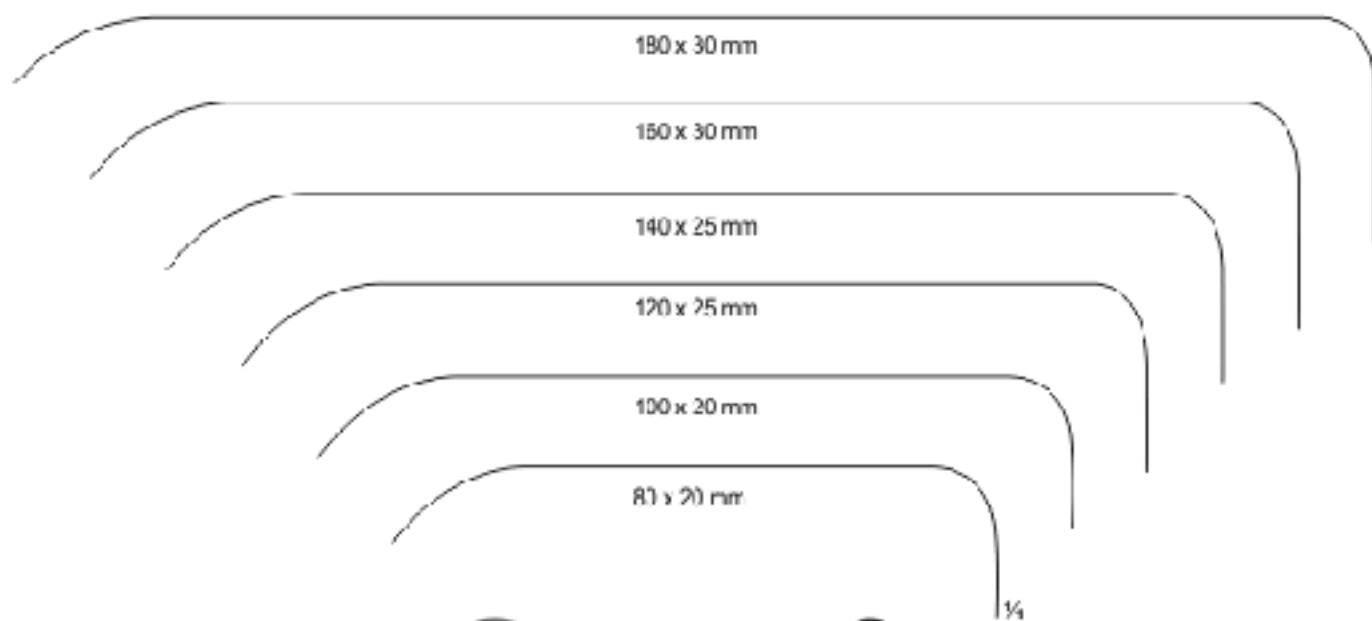

- F0-322** 80 x 20 mm
- F0-323** 100 x 20 mm
- F0-324** 120 x 25 mm
- F0-325** 140 x 25 mm
- F8-326** 160 x 30 mm
- F8-327** 180 x 30 mm

**Brunner Retractor**  
24 cm, 9 1/2"



- F0-328** 100 x 20 mm
- F0-329** 100 x 20 mm
- F0-330** 120 x 25 mm
- F0-331** 140 x 25 mm
- F8-332** 160 x 30 mm
- F8-333** 180 x 30 mm

**Brunner Retractor**  
24 cm, 9 1/2"





**Deaver Retractor**  
**F8-334**  
 18 cm, 7"

**Deaver Retractor**  
**F8-335**  
 21.5 cm, 8 1/2"

**Deaver Retractor**  
**F8-336**  
 23 cm, 9"

**Deaver Retractor**  
**F8-337**  
 30 cm, 11 3/4"

**Deaver Retractor**  
**F8-338**  
 33 cm, 13"

**Deaver Retractor**  
**F8-339**  
 36 cm, 13 1/2"

38 mm



**Deaver Retractor  
F0-340**  
30 cm, 11 3/4"

50 mm



**Deaver Retractor  
F0-341**  
30 cm, 11 3/4"

75 mm



**Deaver Retractor  
F0-342**  
30 cm, 11 3/4"



**S-Shaped Retractor  
F0-343**  
21 cm, 8 1/4"  
12 mm

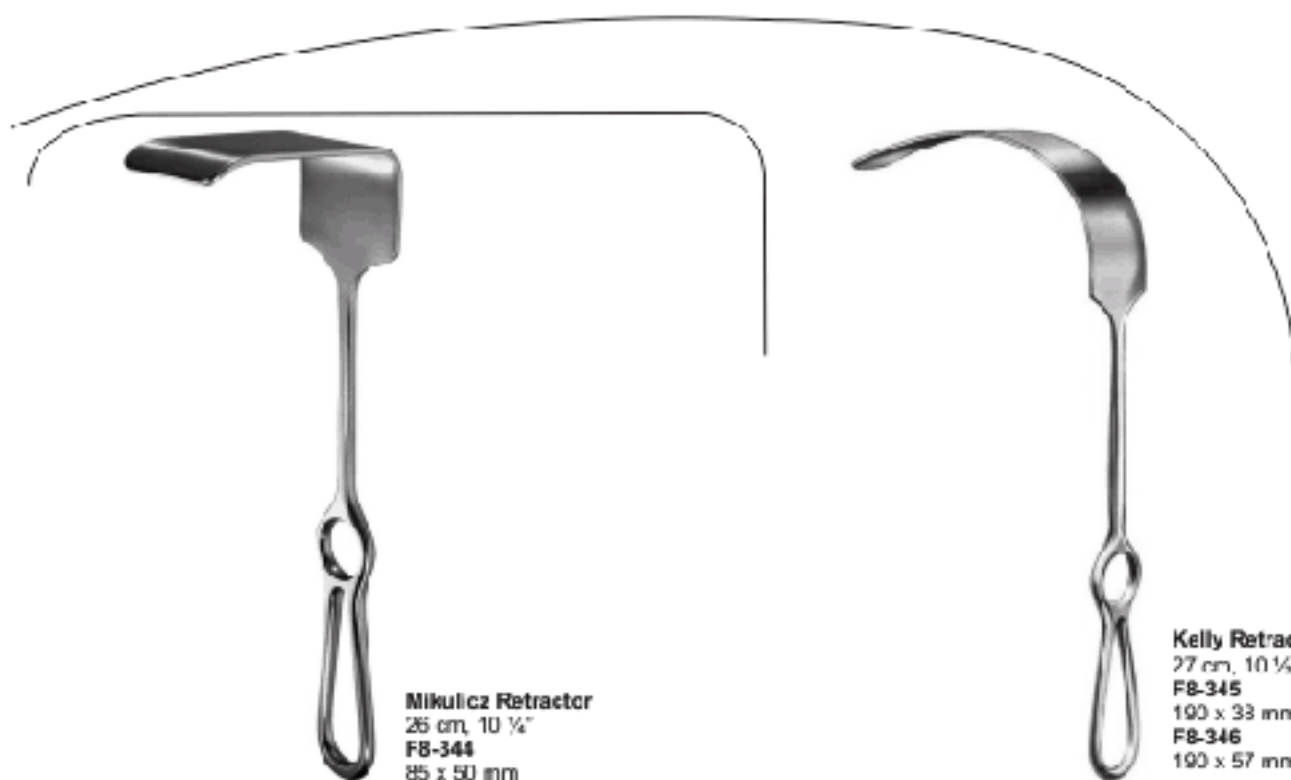

**Mikulicz Retractor**  
 26 cm, 10 1/4"  
**FB-344**  
 85 x 50 mm

**Kelly Retractor**  
 27 cm, 10 1/4"  
**FB-345**  
 100 x 33 mm  
**FB-346**  
 100 x 57 mm

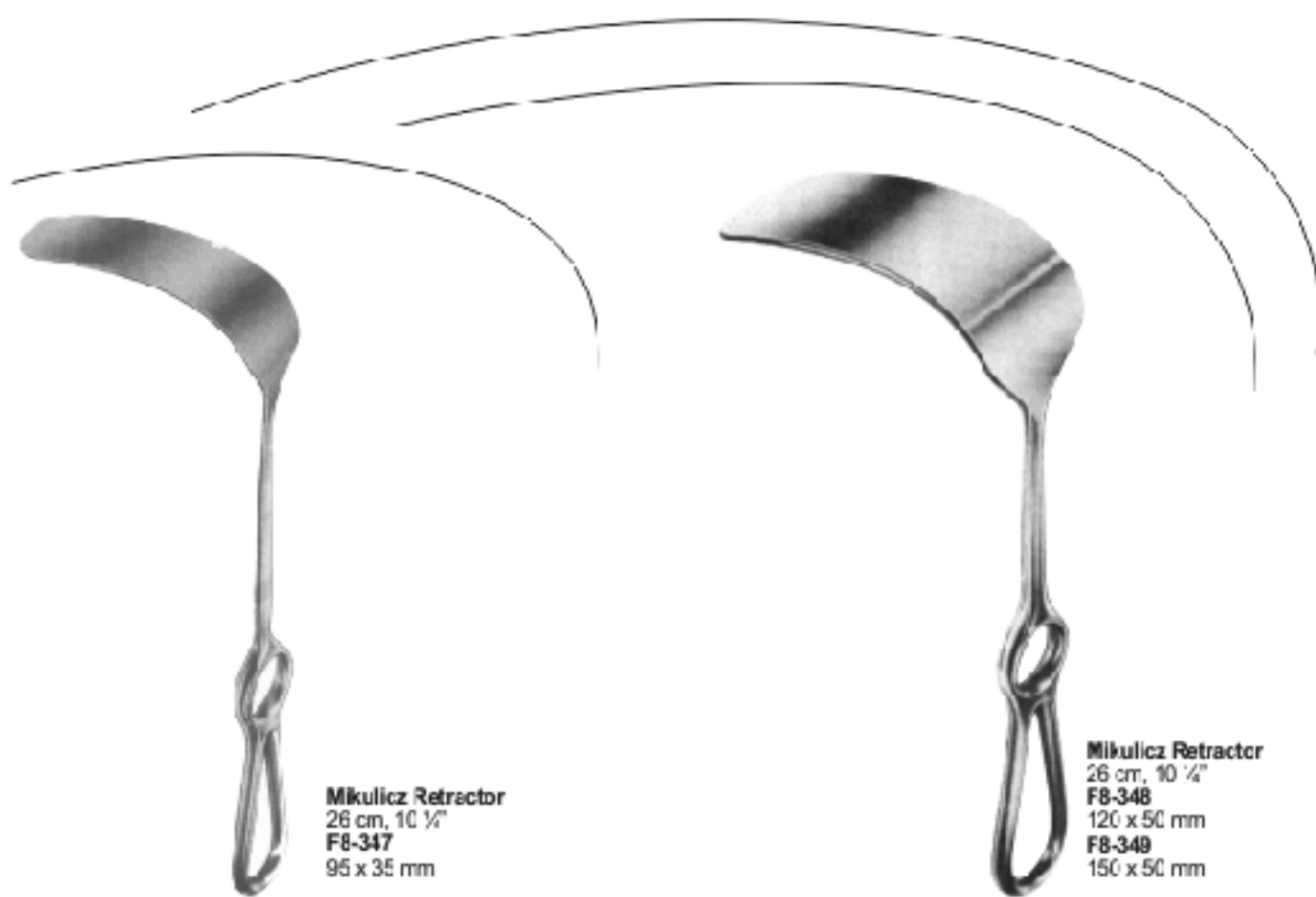

**Mikulicz Retractor**  
 26 cm, 10 1/4"  
**FB-347**  
 95 x 35 mm

**Mikulicz Retractor**  
 26 cm, 10 1/4"  
**FB-348**  
 120 x 50 mm  
**FB-349**  
 150 x 50 mm



**Cheek And Lip Retractor**  
 13 cm, 7 1/2"  
**F8-360**  
 Movable



**Tuffler Retractor**  
 23 cm, 9"  
**F8-361** 65 x 63 mm

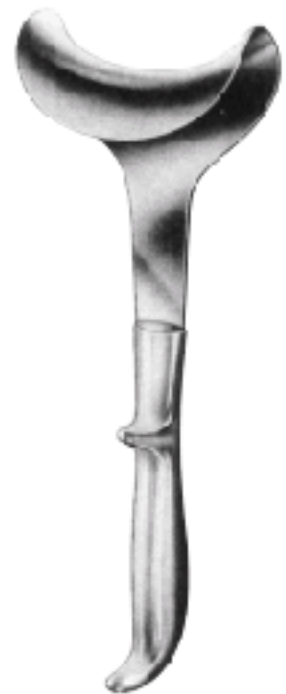

**Doyon Retractor**  
 26 cm, 10"  
**F8-362** 60 x 85 mm



**Fritsch Retractor**  
**F8-353**  
 2.75 x 2 mm



**Fritsch Retractor**  
 24 cm, 9 1/2"  
**F8-354** 35 x 40 mm



**Fritsch Retractor**  
**F8-355** 24 cm, 9 1/2" 30 x 30 mm  
**F8-356** 24 cm, 9 1/2" 32 x 40 mm  
**F8-357** 24 cm, 9 1/2" 40 x 50 mm  
**F8-358** 24 cm, 9 1/2" 40 x 60 mm  
**F8-359** 24 cm, 9 1/2" 45 x 75 mm  
**F8-360** 24 cm, 9 1/2" 65 x 85 mm

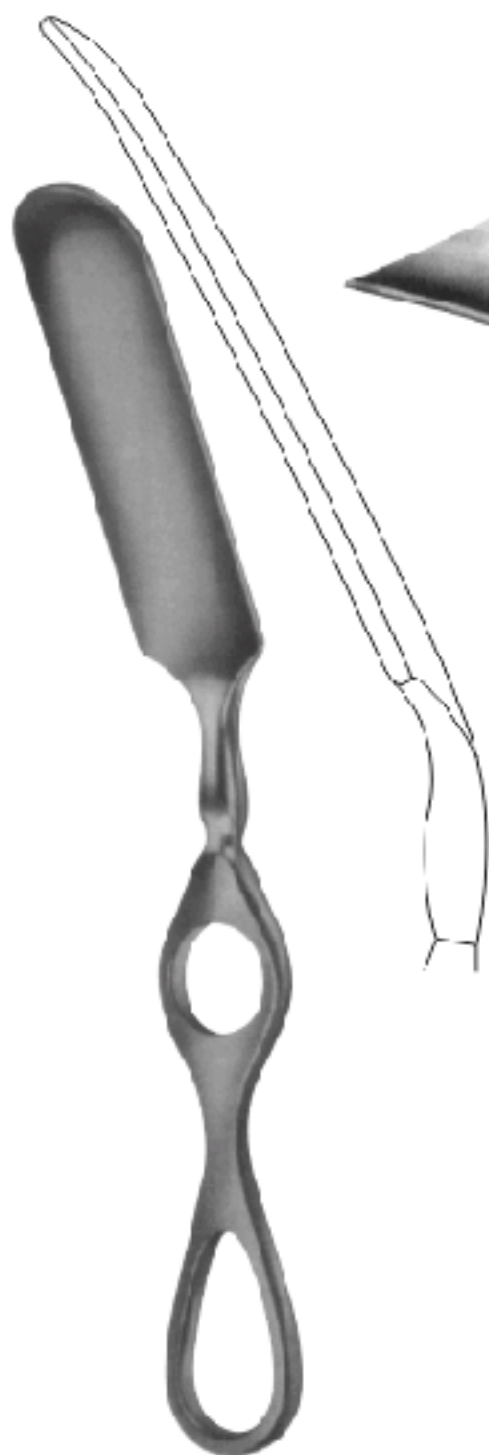

**Mikulicz Retractor**  
F0-361 29 cm 11.5"

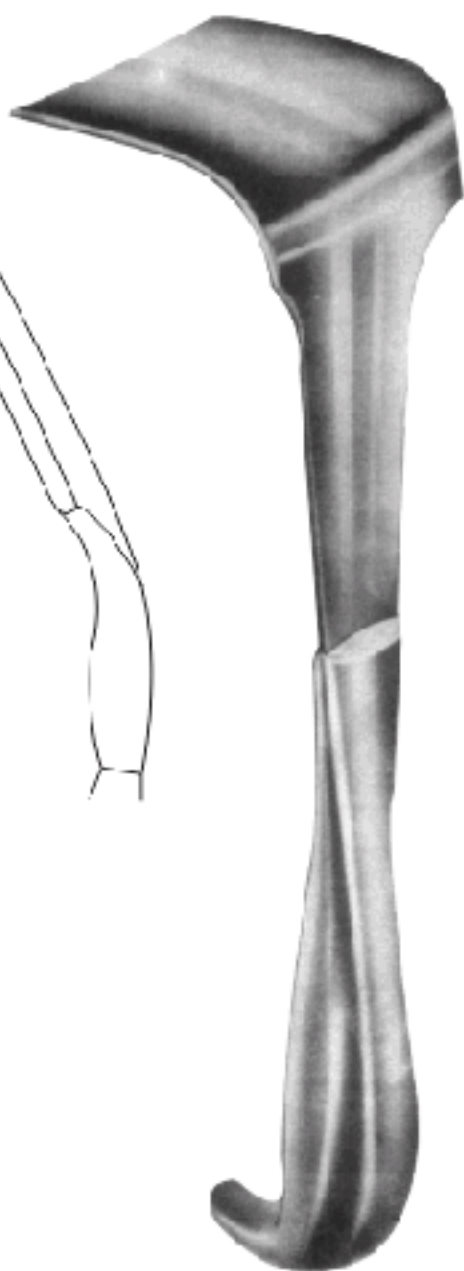

**Tuffier Retractor**  
F3-362 23 cm 9"  
64 x 60mm



**Harrington Retractor**  
32 cm 12 3/4"  
F3-363  
127 x 40mm  
F3-364  
127 x 32mm



**Harrington Extra Deep Retractor**  
**F8-365** 30.0cm 11 3/4"  
 Hollow handle, 5.7cm 2 1/4"  
 width x 20.5cm 8" depth blade

**Harrington Splanchnic Retractor**  
**F8-356** 31.5cm 12 1/2"  
 Hollow handle, 3.8cm 1 1/2"  
 width x 12.0cm 4 3/4"  
 depth blade

**Debaquey-Cooley Retractor**  
**F8-367** 31.0cm 12 1/4"  
 Hollow handle, 5.7cm 2 1/4"  
 width x 18.4cm 7 1/4"  
 depth blade

Wundhaken, Venenhäkchen  
 Separadores, Ganchoes Para venas

Écarteurs, Écarteurs sous  
 Divaricatori, Divaricatori per vena



**Moyerding Retractor**  
 FB-368  
 22.5 cm, 9"  
 75 x 25mm



**FB-369**  
 50 x 16mm



**FB-370**  
 75 x 15mm

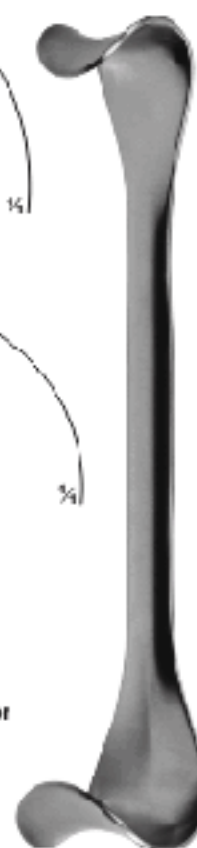

**Geelet Retractor**  
 FB-371  
 19 cm 7 1/2"  
 Double Ended



30 x 30 mm

40 x 40 mm



**Kaye Millard Retractor**  
 FB-372  
 8 cm, 3 1/4"



**Richardson/Kelly Retractor**  
 24 cm, 9 1/2"



**FB-373**  
 5 x 31mm



**FB-374**  
 19 x 51mm



**FB-375**  
 30 x 51mm



**FB-376**  
 64 x 76mm



**Ross Retractor**  
25.5 cm, 10"



**FB-377**  
Fig.31



**FB-378**  
Fig.02



**FB-379**  
Fig.03



**FB-380**  
Fig.04



**FB-381**  
Fig.05



**FB-382**  
Fig.06



**Wainberg Vagotomy  
Retractor (Jee's Hoe)**  
**FB-383**  
20 cm, 3"  
Blade 102 x 165 mm wide



**Turner-Dryden Retractors**  
23.5 cm 9 1/4"  
**FB-384**  
Blade 140 x 60 mm wide  
**FB-385**  
Blade 75 x 140 mm wide  
**FB-386**  
Blade 155 x 76 mm wide

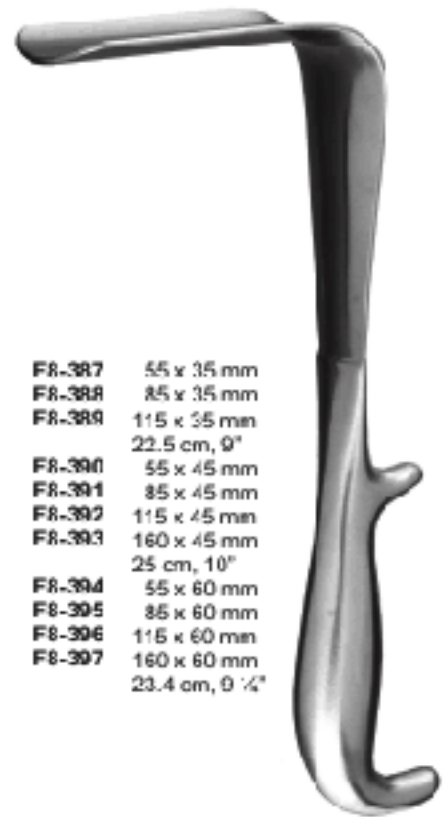

**Doyen Vaginal Retractors**

- FB-387** 55 x 35 mm
- FB-388** 85 x 35 mm
- FB-389** 115 x 55 mm  
22.5 cm, 9"
- FB-390** 55 x 45 mm
- FB-391** 85 x 45 mm
- FB-392** 115 x 45 mm
- FB-393** 160 x 45 mm  
25 cm, 10"
- FB-394** 55 x 60 mm
- FB-395** 85 x 60 mm
- FB-396** 115 x 60 mm
- FB-397** 160 x 60 mm  
23.4 cm, 9 1/4"



**Sawyer Retractors**
**F8-390**

Small Blade 70 mm x 19 mm wide

23 cm 9"

**F8-398**

Medium Blade 02 mm x 29 mm wide

25 cm 10"

**F8-400**

Large Blade 22 mm X 64 mm

27.9 cm 11"

**F8-401**

Large Blade 38 mm X 89 mm

27.9 cm 11"

**Ferguson-Moos Rectal Retractors**
**F0-402**

Blade 60 mm x 24 mm wide

23 cm 9"

**F0-403**

Blade 75 mm x 35 mm wide

25 cm 10"

**Hill Ferguson Rectal Retractors**
**F3-404**

Blade 64 mm x 24 mm wide

23 cm 9"

**F3-405**

Blade 70 mm x 32 mm wide

23 cm 9"

**F3-406**

Blade 76 mm x 35 mm wide

25 cm 10"

**F8-407** 24 cm 9 1/2"  
 50 x 40 mm wide

**F8-408** 24 cm 9 1/2"  
 65 x 50 mm wide

**F8-409** 25 cm 10"  
 75 x 65 mm wide

**F8-410** 25 cm 10"  
 90 x 76 mm wide

**Kelly Retractors**

**Richardson Retractors**

**F8-411** 24 cm 9 1/2"  
 Blade 25 x 20 mm wide

**F8-412** 24 cm 9 1/2"  
 Blade 36 x 28 mm wide

**F8-413** 24 cm 9 1/2"  
 Blade 44 x 28 mm wide

**F8-414** 25 cm 10"  
 Blade 52 x 22 mm wide

**F8-415** 25 cm 10"  
 Blade 70 x 52 mm wide

**Kelly Retractor**  
**F3-416**  
 25 cm, 10"  
 55 x 50 mm



**Richardson-Estman Retractor**  
25.0 cm 10", Set of 2 piece

**F8-419**  
23 x 20 mm

**F8-420**  
31 x 29 mm

**F8-421**  
37 x 37 mm

**F8-418**  
39 x 30 mm

**F8-417**  
64 x 43 mm



**Richardson Retractor**  
24.0 cm 9.5"



**Richardson Retractor**  
**F8-422**  
24.0 cm 9.5"

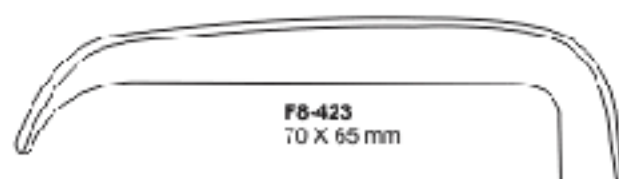

**F8-423**  
70 X 65 mm



**F8-424**  
64 X 54 mm

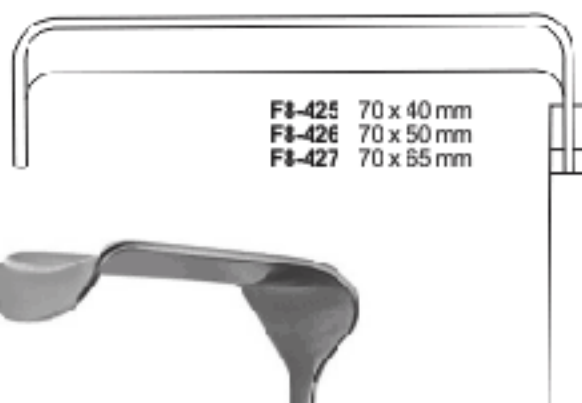

**F8-425** 70 x 40 mm  
**F8-426** 70 x 50 mm  
**F8-427** 70 x 65 mm



**Kelly Retractor**  
26.0 cm 10 1/4"



**Morris Retractor**  
24.5 cm 9 3/4"



Item	Description	Tip
F8-428	20 cm, 8"	12 mm
F8-429	20 cm, 8"	17 mm
F8-430	20 cm, 8"	25 mm
F8-431	33 cm, 13"	25 mm
F8-432	33 cm, 13"	32 mm
F8-433	33 cm, 13"	40 mm
F8-434	33 cm, 13"	50 mm

**Malleable Retractor**

**Ribbon Retractor**  
**F8-436**  
 20 cm, 8"  
 Width 4 cm

**Ribbon Retractor**  
**F8-436**  
 20 cm, 8"  
 Width 2.5 cm

**Tuffier / Haberer Retractor**  
**F8-437** 20 cm, 8" 17 x 25 mm  
**F8-438** 28 cm, 11" 25 x 20 mm  
**F8-439** 30 cm, 11 3/4" 37 x 45 mm  
 malleable

**Reverdin Retractor**  
**F8-440** 20 cm, 11"  
 4G x 60 mm

**Reverdin Retractor**  
**F8-441** 28 cm, 11 1/2"

**Blood Scoop**  
**F8-442** 15 cm, 6"

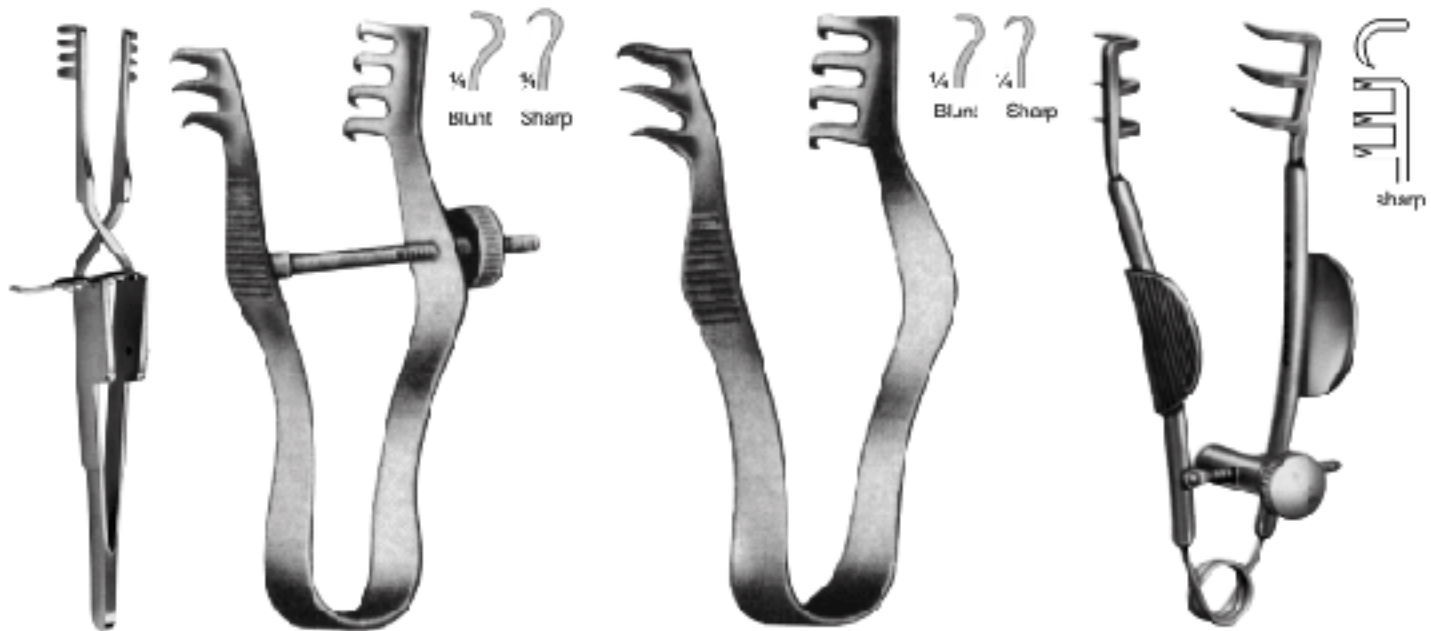

**Heiss Retractor**  
**FB-443** 10 cm, 4"  
 Sharp 4:4  
**FB-444** 10 cm, 4"  
 Blunt 4:4

**Finsen Retractor**  
**FB-445** 7 cm, 2 3/4"  
 3 x 4 teeth, sharp  
**FB-446** 7 cm, 2 3/4"  
 3 x 4 teeth, Blunt

**Finsen Retractor**  
**FB-447** 5 cm, 2"  
 2 x 3 teeth sharp/blunt  
**FB-448** 7 cm, 2 1/4"  
 2 x 3 teeth sharp/blunt

**Buckley Retractor**  
**FB-449**  
 6 cm, 2 1/2"



**Lancaster Eye Speculum**  
**FB-450**  
 8.3 cm 3 1/4",  
 blades 15 X 5 mm

**Castroviejo Eye Speculum**  
**FB-451**  
 9.5 cm 3 3/4",  
 medium blades  
 15 X 5 mm C.D.

**Wire Retaining Retractor**  
**FB-452** 8.5 cm, 3 1/2" 3 x 3 Prong  
**FB-453** 8.5 cm, 3 1/2" 1 x 1 Prong Sharp

**Fair Wire Retractor**  
**FB-454** 14 cm 5 1/2"  
 prongs .9 cm 3/4"

**ALM Retractor**  
**FB-455** 7 cm, 2 1/2"  
 4 x 4 teeth sharp/blunt  
**FB-456** 10 cm, 4"  
 4 x 4 teeth sharp/blunt



**Jansen Retractor**  
**F3-457** 10 cm, 4"  
 Sharp 3x3  
**F3-456** 10 cm, 4"  
 Burt 3x3



**Housel Retractor**  
**F8-459** 29 cm, 11 1/2"

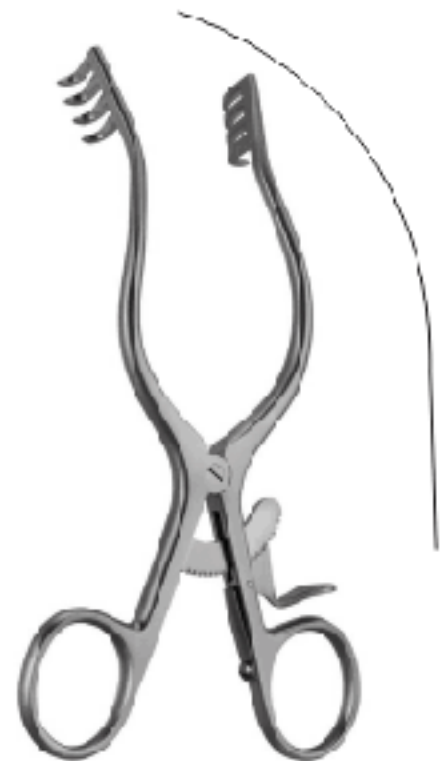

**Mollison Retractor**  
**F8-460** 15 cm, 6"  
 sharp



**Markham/Meyering Retractor**  
**F0-461** 10 cm, 7" Blade 55 x 25 mm Left  
**F0-462** 10 cm, 7" Blade 55 x 25 mm Right



**Milligan Retractor**  
**F0-463** 13 cm, 5"  
 10.5 mm x 20 mm  
 Blunt 3x3



**Darling Retractor**  
**F0-454** 10 cm, 7"  
 40 x 70/25 x 54 mm  
**F0-455** 10 cm, 7"  
 25 x 64/40 x 76 mm  
 Laminectomy Retractors  
 1 blade toothed



**Debaquey Gelpi Retractor**  
**F8-466** 13.5cm 5 3/8"  
 Spread 3 1/8" 8cm. Sharp.



**Gelpi-Loktite Retractor**

- F8-467** 9 cm, 3 1/2"  
6 mm Sharp
- F8-468** 11 cm, 4 1/4"  
10 mm Sharp
- F8-469** 14 cm, 5 1/2"  
10 mm Sharp
- F8-470** 16 cm, 6 1/2"  
10 mm Sharp
- F8-471** 18 cm, 7 1/2"  
10 mm Sharp



**Gelpi-Perineal Retractor**  
**F8-472** 17.8 cm, 7"  
 ball stops on sharp teraculum prongs.  
 arm length 4-3/4" 2.1cm



**Gelpi-Loktite Retractor**  
**F8-473** 9 cm, 3 1/2" 6 mm Sharp CROSS OVER  
**F8-474** 11 cm, 4 1/4" 10 mm Sharp CROSS OVER  
**F8-475** 14 cm, 5 1/2" 10 mm Sharp CROSS OVER  
**F8-476** 16 cm, 6 1/2" 10 mm Sharp CROSS OVER  
**F8-477** 19 cm, 7 1/2" 10 mm Sharp CROSS OVER



**Seletz-Gelpi Retractor**  
**F8-478** 17.8cm, 7"  
 modified with long  
 curve in snanks



**Schuhknecht Retractor**  
**F8-479** Sharp  
**F8-480** Blunt  
 14 cm, 5 1/2"



**Wullstein Retractor**  
 F8-481 F8-484 10.5 cm, 4"  
 F8-482 F8-485 13.0 cm, 5"  
 F8-483 F8-486 16.0 cm, 6 1/4"  
 Sharp Blunt



**Travers Retractor**  
 F8-487  
 21 cm, 8 1/4" Blunt



**Rigby Retractor**  
 F8-488 35 x 20 mm  
 F8-489 50 x 20 mm  
 F8-490 35 x 15 mm  
 18 cm, 7"

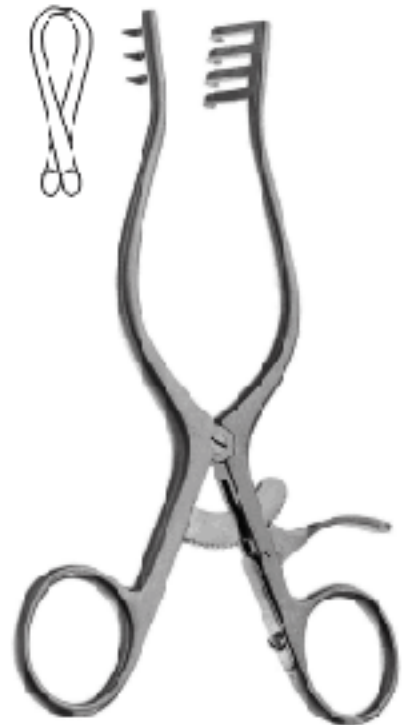

**Weitlaner Retractor**  
 F8-491  
 13.0 cm 5.25"  
 Sharp



**Weitlaner Retractor**  
 F8-492  
 16.5 cm 6.5"  
 Sharp



**Plester Retractor**  
 F8-493  
 11.0 cm 4.25"  
 Blunt

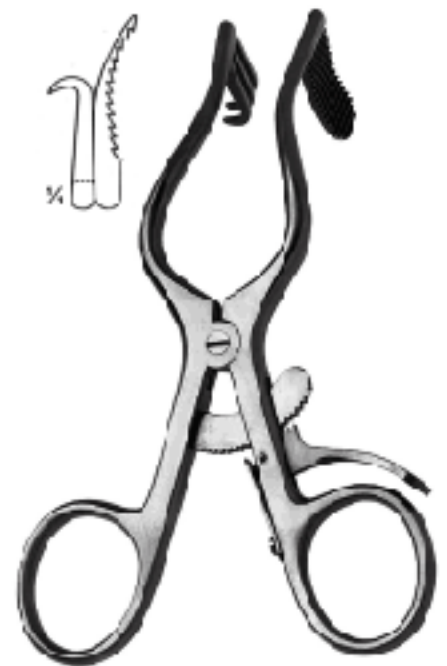

**Perkins Retractor**  
 F8-494  
 13.0 cm 5.25"





**Weitlaner Retractor**  
F8-495  
11.0 cm  
Sharp



**Weitlaner Retractor**  
F8-496  
11.0 cm  
Semi-Sharp



**Weitlaner Retractor**  
F8-497  
11.0 cm  
Blunt



**Weitlaner Retractor**  
F8-498  
13.0 cm  
Sharp



**Weitlaner Retractor**  
F8-499  
13.0 cm  
Semi-Sharp



**Weitlaner Retractor**  
F8-500  
13.0 cm  
Blunt



**Kolbel Soft Tissue Retractor**  
**F8-501** 13.0cm 7"  
 Angled, 2 x 2 Pronged



**Meyerdling Retractor**  
**F8-502** 16.5cm 6 1/2"  
**F8-503** 24.1cm 9 1/2" Large Blade  
 8.3 cm 3 1/2" X 5.1 cm 2"  
**F8-504** 24.1 cm 9 1/2" Small Blade  
 5.1 cm 2" X 1.6 cm 5/8"



**D'Errico-Adson Retractor**  
**F8-505** 19.0cm 7 3/8"  
 4 X 4-pronged,  
 2.0cm 3/4" depth blade  
 Sharp



**Anderson-Adson Retractor**  
**F8-506** 19.0 cm 7 1/2"  
 Sharp



**Norfolk & Norwich Retractor**  
**F8-507** 22.0 cm 8 1/4"  
 Blunt



**Adson Retractor**  
**F8-508**  
 19.1 cm 7-1/2" sharp,  
 4 X 4 teeth straight Arms



**Adson Retractor**  
**F8-509** 26.5 cm 10 1/2"  
 Sharp



**Deckman-Weitlaner  
Retractor**  
**F0-510**  
 16.5cm 6 1/2"  
 3 x 4 Sharp prongs



**Deckman-Weitlaner  
Retractor**  
**F0-511**  
 16.5cm 6 1/2"  
 3 x 4 Blunt prongs

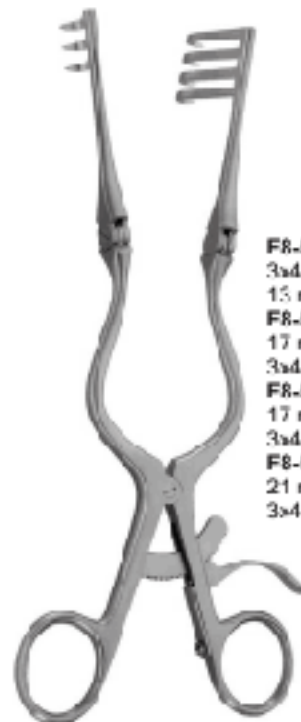

**F8-512** 31 cm, 12"  
 3x4 Blunt prongs,  
 15 mm x 14.5 mm  
**F8-513** 16.5 cm, 6 1/2"  
 17 mm x 19 mm  
 3x4 Sharp prongs,  
**F8-514** 16.5 cm, 6 1/2"  
 17 mm x 19 mm  
 3x4 Blunt prongs,  
**F8-515** 20 cm, 8"  
 21 mm x 210 mm  
 3x4 Blunt prongs,

**Cone Retractor**



**Beckman Retractor**  
**F8-516** 31.7cm 12 1/2"  
 Spread 3.5cm 5 3/8" 4 x 4  
 Sharp prongs. Arm length  
 8.5cm 3 3/8"



**Beckman Retractor**  
**F8-517** 31.1cm 12 1/4"  
 4 x 4 Sharp prongs 27mm.  
 Side Blade 1.7cm 5/8" deep.



**Beckman Retractor**  
**F8-518** 31.1cm 12 1/4"  
 4 x 4 Blunt prongs 27mm.  
 Side Blade 1.7cm 5/8" deep.



**Joll (Friedman)**  
**F8-519** 15.5 cm, 6 1/2"  
 Thyroid- and Vaginal Retractor

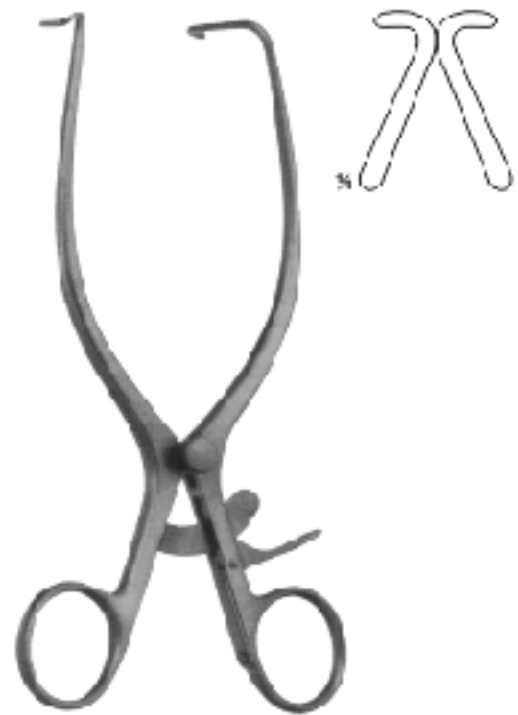

**Jackson Burrows Retractor**  
**F8-520** 13.5 cm, 7"  
 Blunt



**Gelpi Vagina Retractor**  
**F8-521** 13.5 cm, 5"



**Gelpi Skin & Vaginal Retractor**  
**F8-522** 17.5 cm, 7"



**De Bakley Femur Retractor**  
**F8-523** 14.5 cm, 4 1/2"

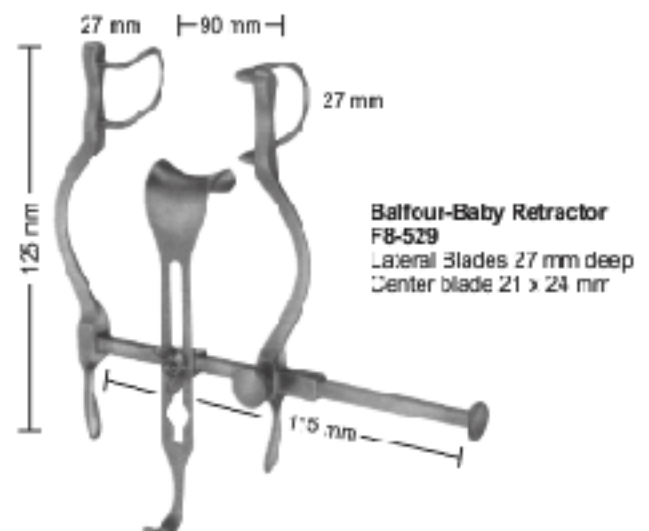
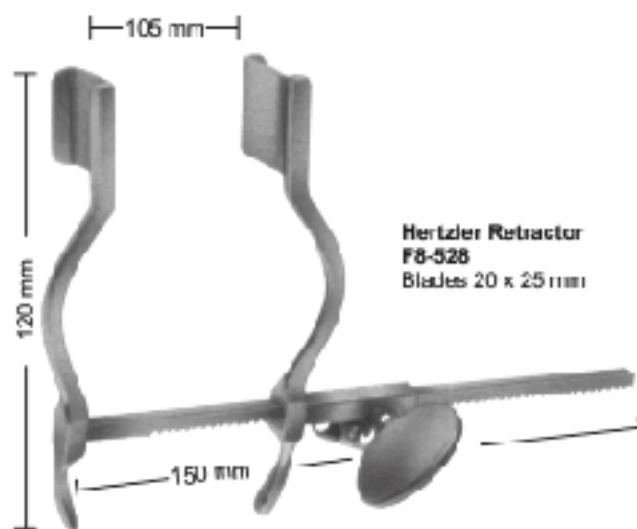
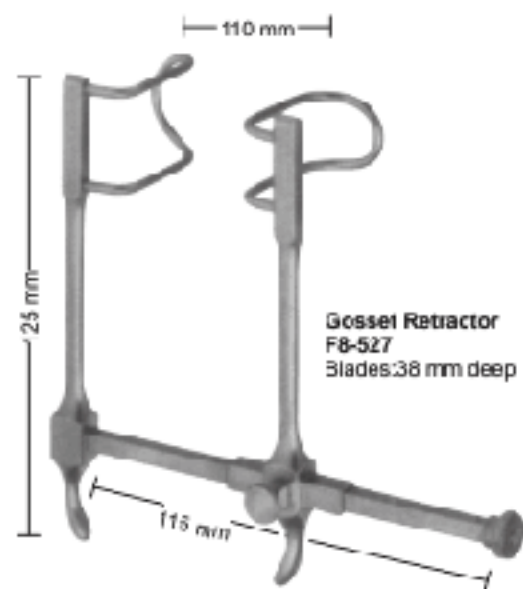
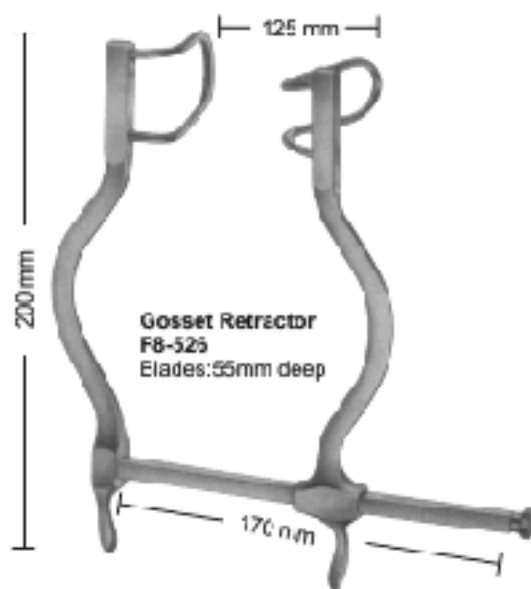
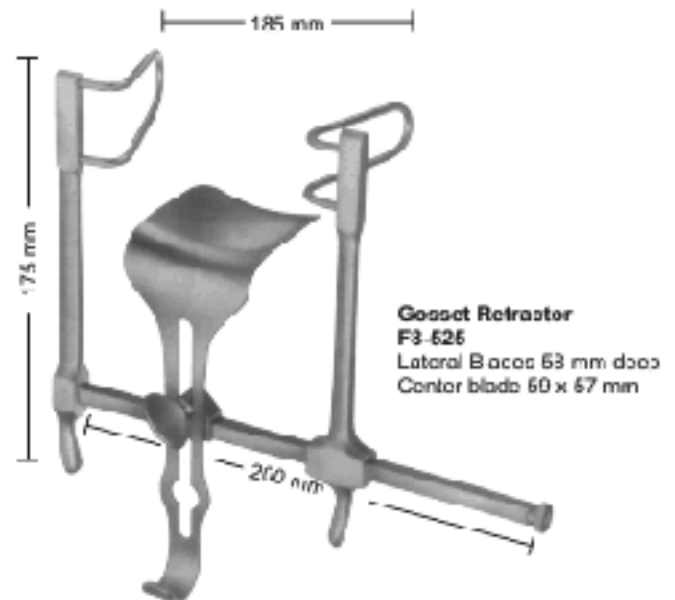

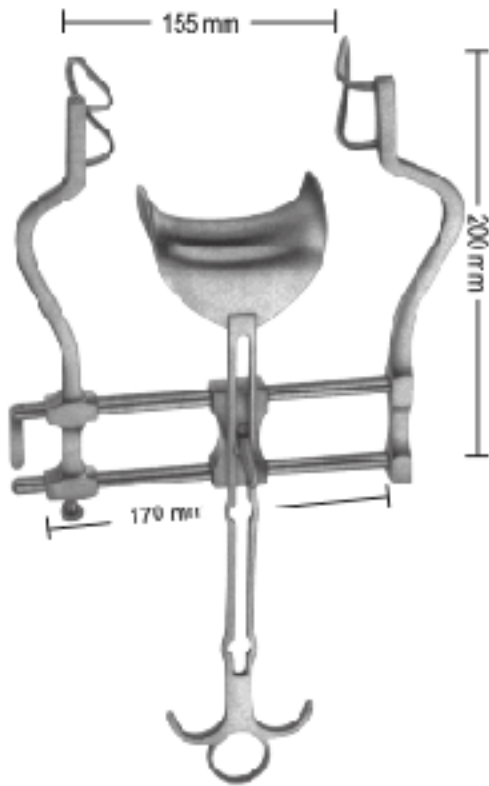

**Balfour Retractor  
FB-530**  
 Lateral blades 60 mm deep  
 Center blade 47 x 80 mm

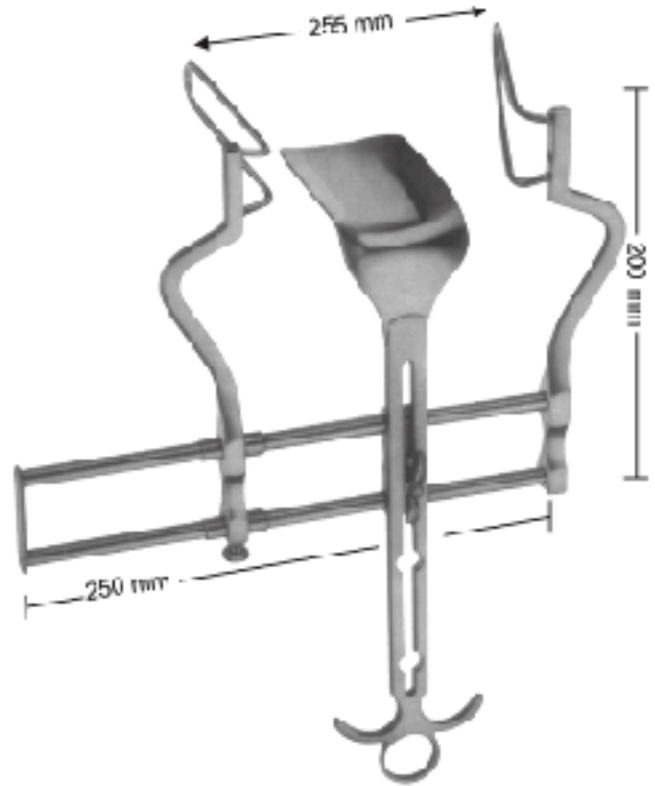

**Balfour Retractor  
FB-531**  
 Lateral blades 105 mm deep  
 Center blade 107 x 80 mm

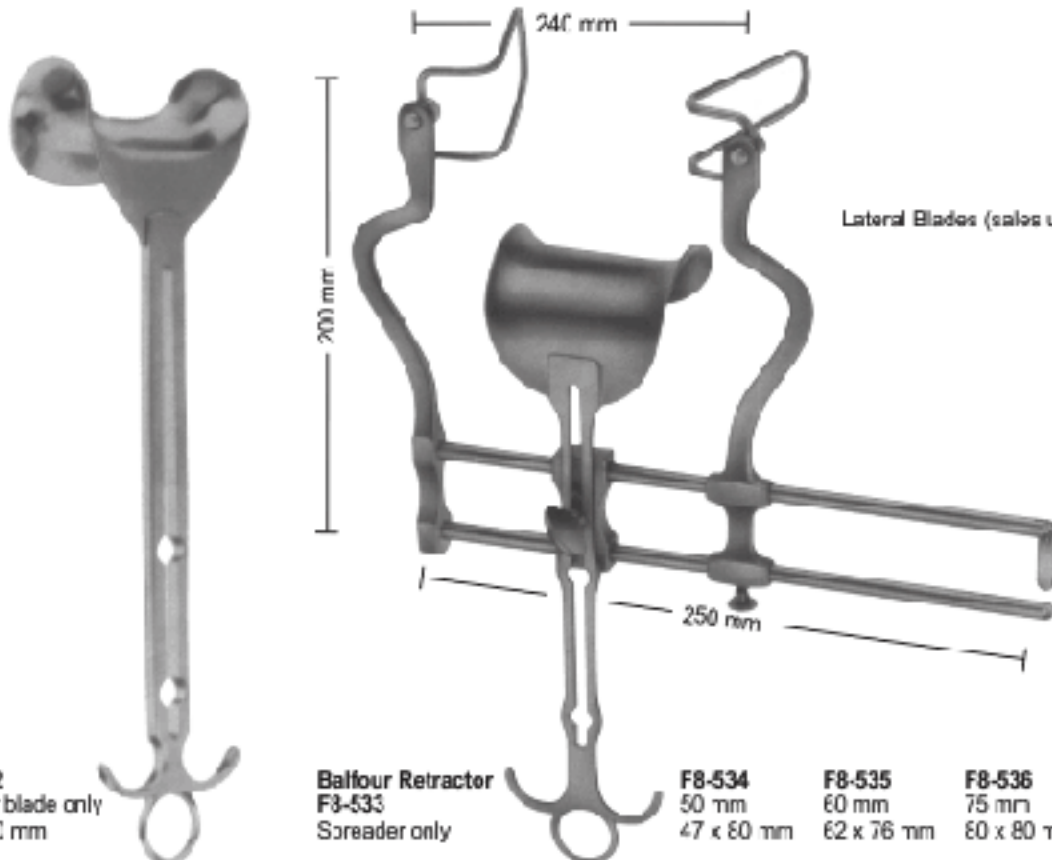

Lateral Blades (sales unit of blades in pairs)

**F8-532**  
 Center blade only  
 54 x 80 mm

**Balfour Retractor  
F8-533**  
 Spreader only

**F8-534**  
 50 mm  
 47 x 80 mm

**F8-535**  
 60 mm  
 62 x 76 mm

**F8-536**  
 75 mm  
 60 x 80 mm

**F8-537**  
 90 mm  
 60 x 80 mm



**D'Sullivan/O'Connor Retractor**  
**F8-538** (Set includes frame & 3 blades)  
**F8-539** Frame Only (not pictured)



**F8-540**  
 Single Retractor Blade  
 110 x 70 mm



**F8-541**  
 Set of 2 Retractor Base  
 30 x 45 mm



**F8-642**  
 Corner Blade  
 45 x 80 mm  
 70 x 85 mm



**F8-543**  
 Center Blade  
 100 x 60 mm

Sizes of These Blades in  
 Same as about Blades.

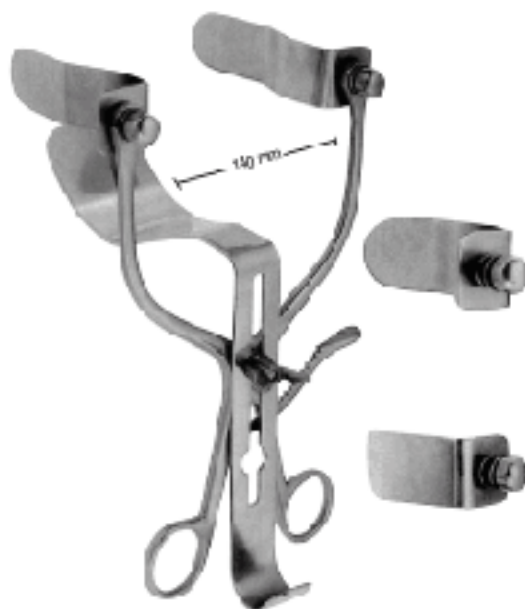

**Collin Retractor**  
**F8-544** Complete  
**F8-545** Spreader only  
**F8-546** Blades 66 x 25 mm  
**F8-547** Blades 80 x 25 mm  
**F8-548** Center Blade  
 115 x 45 mm

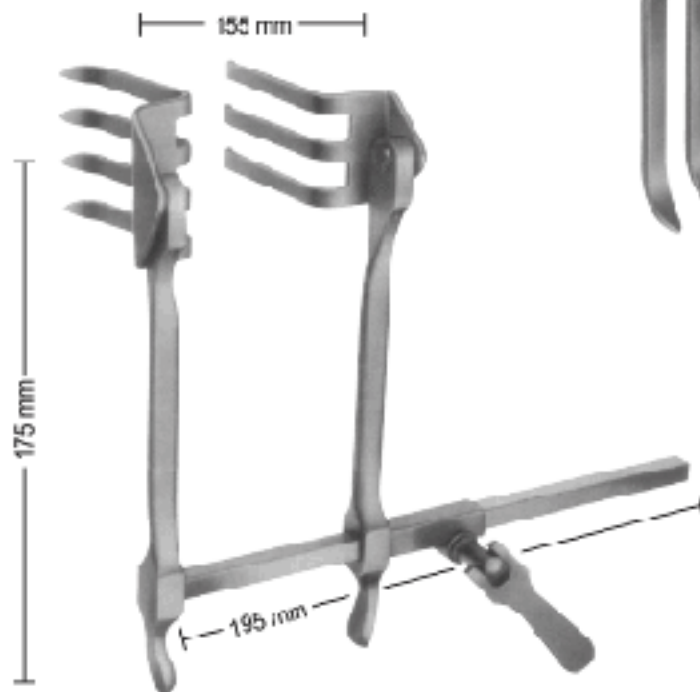

**Scoville-Richter Retractor**  
**F0-549** Complete with 1 pair blades.  
**F0-550** Frame only.  
 The Retractor bar and  
 stanks may be easily  
 rotates 180 when  
 blades are in situ.



**F3-553**  
 62 x 52 mm



**F8-554**  
 62 x 37 mm



**F8-555**  
 47 x 51 mm



**F8-556**  
 30 x 40 mm



**F3-557**  
 37 x 62 mm



**Initial Incision Retractor**  
**F8-558** 30cm 11 3/4"  
 Complete





**Collin Retractor**  
**F8-559** 20 cm, 8"  
 complete with 2 lateral  
 blades and central blade



**Legueu Retractor**  
**F8-560**  
 17 cm, 6 1/2"



**Doyen Retractor**  
**F8-561** 48 mm x 90 mm  
**F8-562** 48 mm x 105 mm  
**F8-563** 48 mm x 120 mm  
**F8-564** 48 mm x 135 mm  
 28 cm, 11"



**Richard Retractor**  
**F8-565** 48 mm x 90 mm  
**F8-566** 48 mm x 105 mm  
**F8-567** 48 mm x 120 mm  
**F8-568** 48 mm x 135 mm  
**F8-569** 48 mm x 155 mm  
 31 cm, 12"

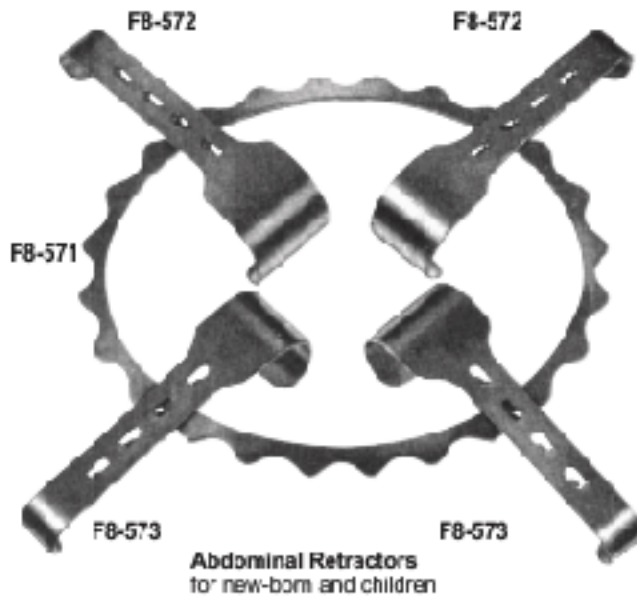

**Abdominal Retractors**  
for new-born and children

**Denis-Browne Retractor**  
FB-570 Complete with 4 blades

- FB-571 Frame 190 x 160 mm
- FB-572 2 blades only 40 x 30 mm
- FB-573 2 blades only 40 x 40 mm

FB-574  
Blades only 20 x 30 mm



FB-575  
Blades only 20 x 40 mm



**Abdominal Retractors**  
well suitable for gynaecologists

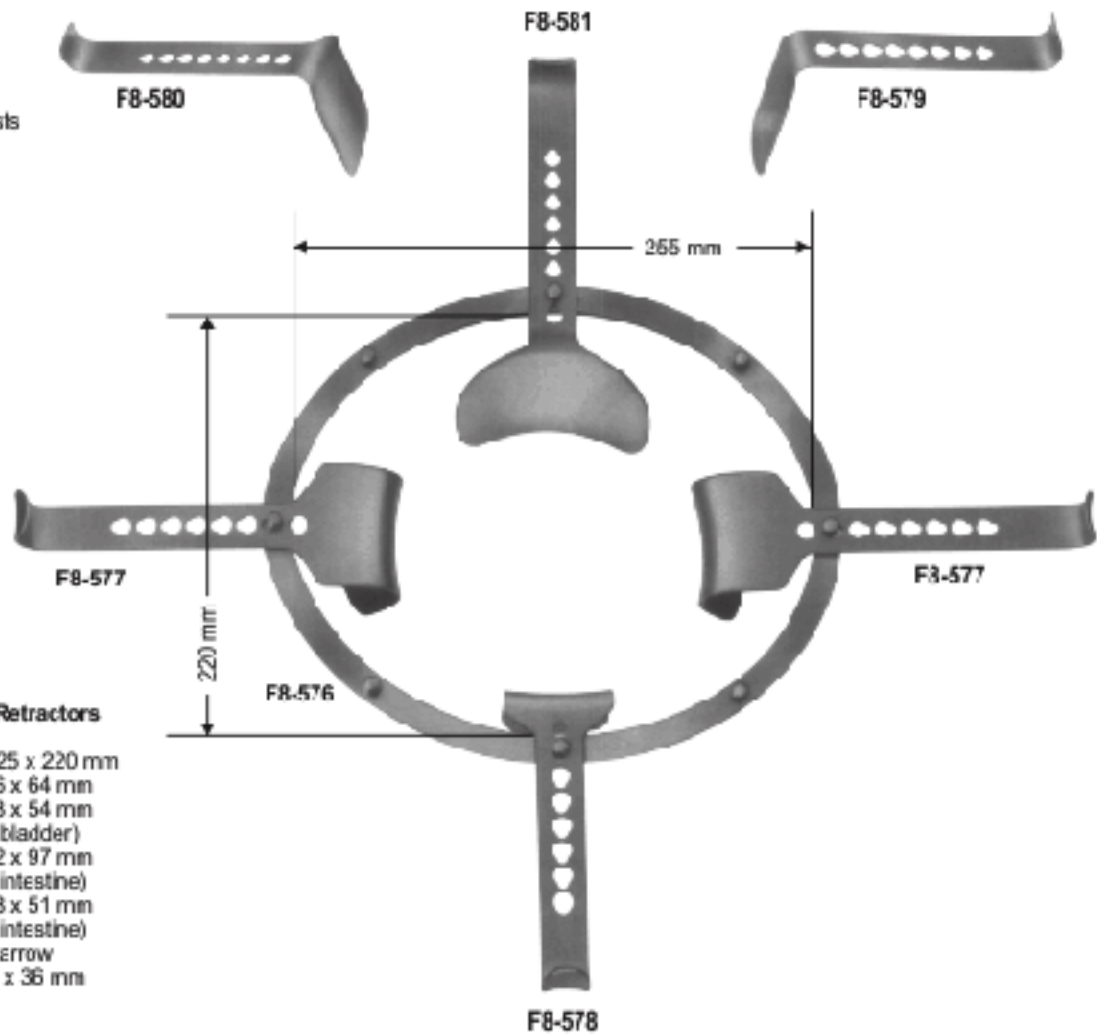

- Senn Abdominal Retractors**  
consisting of:
- FB-576 1 frame 225 x 220 mm
  - FB-577 2 blade 46 x 64 mm
  - FB-578 1 blade 53 x 54 mm  
(for bladder)
  - FB-579 1 blade 32 x 97 mm  
(for intestine)
  - FB-580 1 blade 98 x 51 mm  
(for intestine)
  - FB-581 1 blade, narrow  
107 x 36 mm

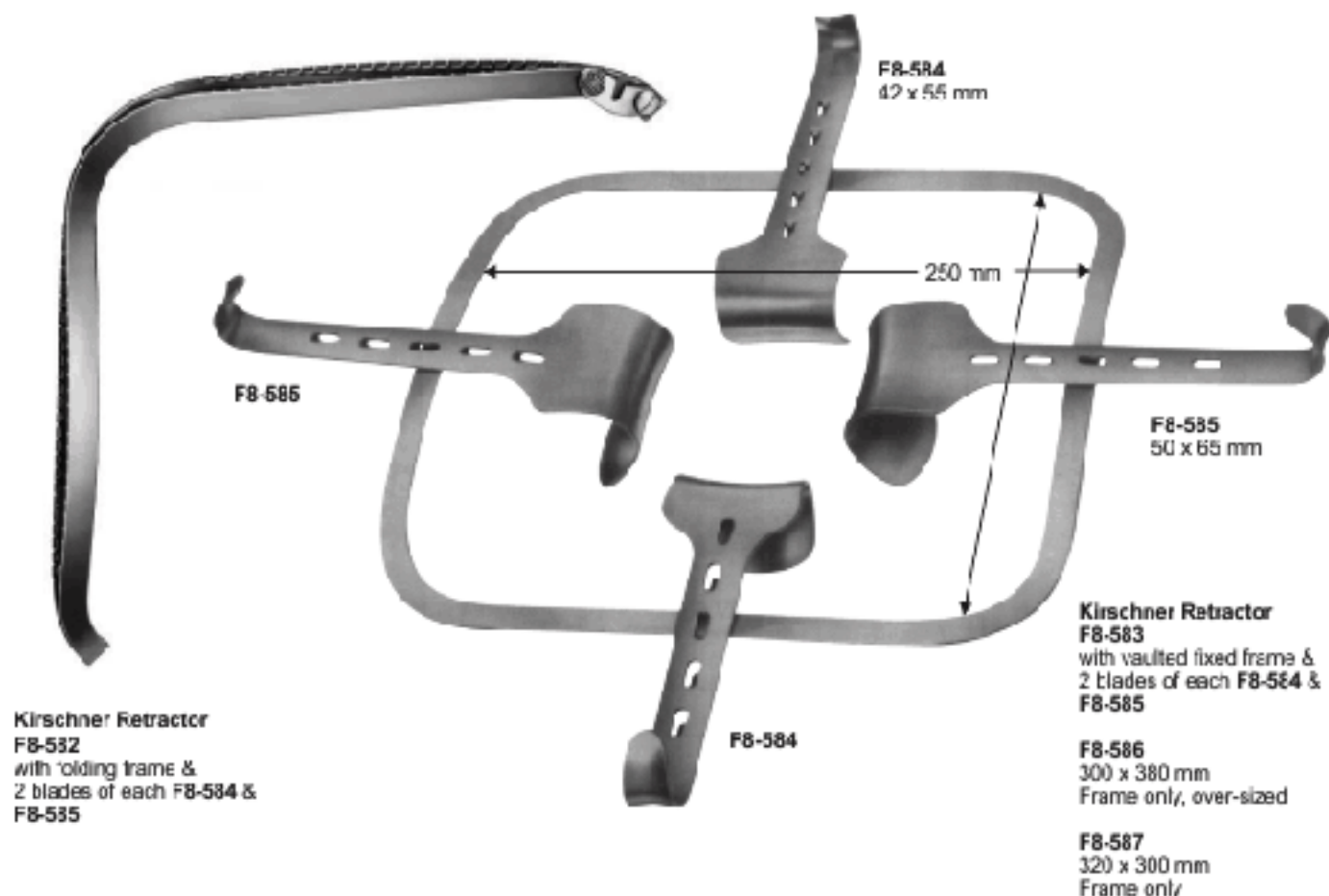

**Kirschner Retractor**  
**F8-582**  
 with folding frame &  
 2 blades of each **F8-584** &  
**F8-585**

**Kirschner Retractor**  
**F8-583**  
 with vaulted fixed frame &  
 2 blades of each **F8-584** &  
**F8-585**

**F8-586**  
 300 x 380 mm  
 Frame only, over-sized

**F8-587**  
 320 x 300 mm  
 Frame only

Additional valves for corpulent persons



**Kirschner Retractor**  
**F8-588**  
 64 x 80 mm

**Kirschner-Belfour**  
**Retractor**  
**F8-589**  
 80 x 82 mm

**Kirschner Retractor**  
**F8-590** 90 x 69 mm  
**F8-591** 92 x 95 mm  
**F8-592** 78 x 58 mm

**Kirschner Retractor**  
**F8-593** 108 x 42 mm  
**F8-594** 91 x 55 mm  
**F8-595** 121 x 55 mm



# BONE SURGERY INSTRUMENTS





**Charriere Saw**  
**F9-001** 35cm 13 3/4"  
 Spare saw blades  
**F9-002** 12mm  
**F9-003** 15mm



**Charriere Bone Saw Complete**  
**F9-004** 35.5cm 14"  
 Straight tip, Straight shaft



**Helfrich-Bier Saw**  
**F9-005** 39cm 15 1/4"  
 Spare saw blades  
**F9-006** 3mm  
**F9-007** 5mm  
**F9-008** 5mm



**Engel Plaster Saw**  
**F9-009** 15.5 cm, 6"



**Percy Amputation Shield**  
**F9-010**  
 30.5cm 12"  
 Handles Detachable,  
 Simple Pattern

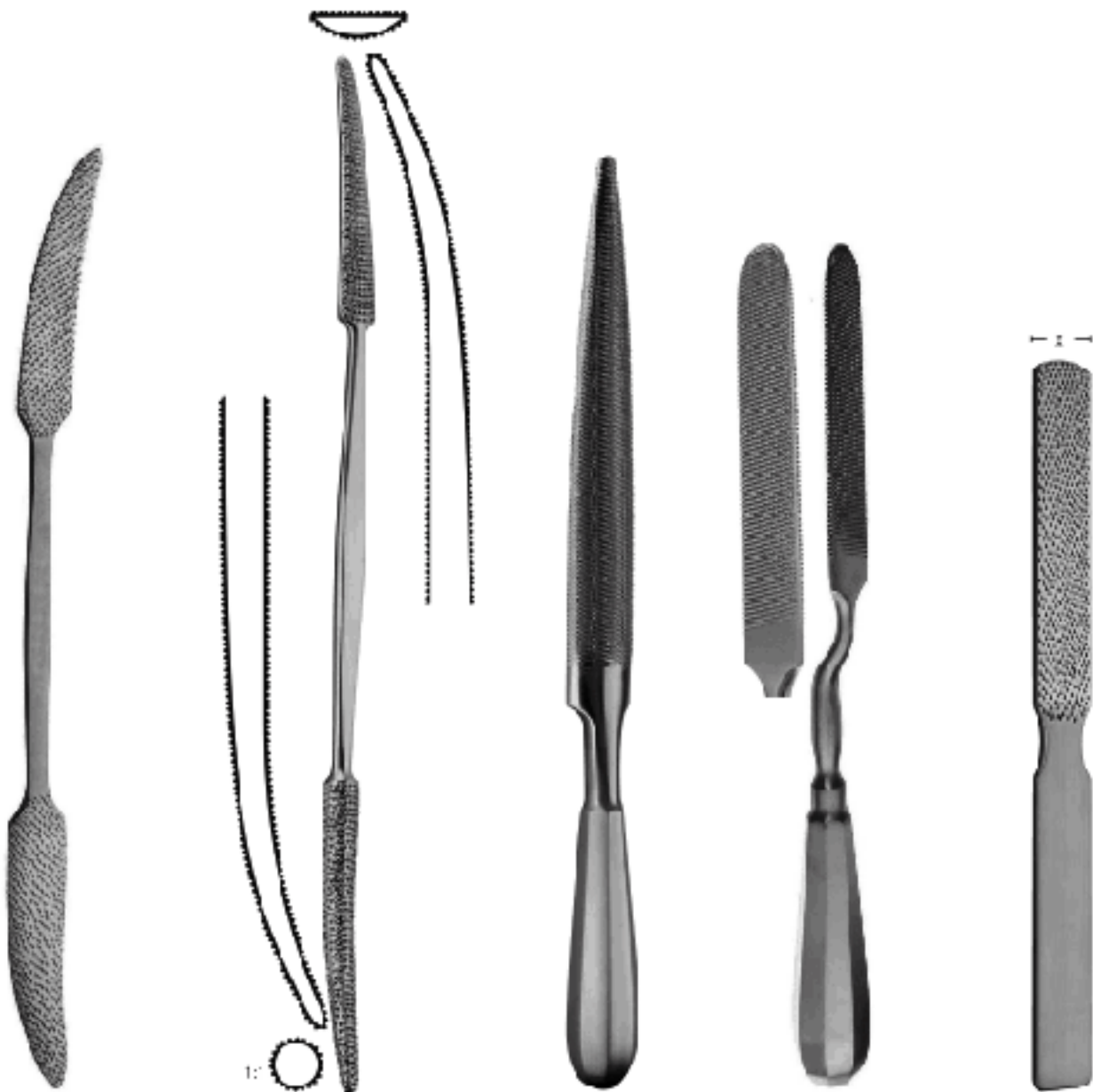

**Putti Bone Rasp**  
**F9-011**  
 27.0 cm 10 3/4"  
 Double ended, One end curved up  
 one end curved sideways

**Putti Rasp**  
**F9-012**  
 30.0 cm 12"  
 Double Ended

**Putti Bone File**  
**F9-013**  
 26.0 cm 11"  
 semicircular

**Putti Bone File**  
 Bayonet Shape  
**F9-014**  
 24.5 cm 9 3/4"  
 X=13 mm  
 semicircular

**Putti Bone File**  
**F9-015**  
 22.0 cm 8 3/4"  
 X=20 mm  
 flat



**Foman Rasp**  
**F9-016** 21.5cm 8 1/2"  
 Double ended, Fine &  
 coarse serrations  
 4-sided convex and  
 flat blades



**Foman Rasp**  
**F9-017**  
 21 cm, 8 3/8"



**Miller-Colburn Bone File**  
 18 cm, 7"



Fig. 1  
**F9-018**

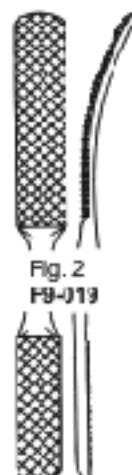

Fig. 2  
**F9-019**



Fig. 3  
**F9-020**



Fig. 4  
**F9-021**

cross cut



**Kleinert-Kutz Bone Rasp**  
**F9-022** 22.5cm 8 7/8"  
 Double ended,  
 Fine & coarse serrations



**Miller Alveotomy File**  
**F9-023**  
 19 cm, 7 1/2"

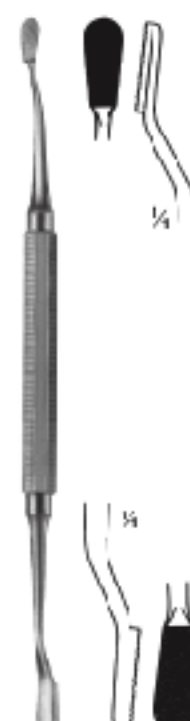

**Miller Alveotomy File**  
**F9-024**  
 19 cm, 7 1/2"



**Doyen Mallets**  
 25cm 7 3/4"  
**F9-025** 25mmØ - 120g  
**F9-026** 30mmØ - 180g  
**F9-027** 35mmØ - 260g



**Collin Mallets**  
**F9-028** 20cm 8"  
 30mmØ - 220g



**Hajak Mallets**  
**F9-029** 21.5cm 8 1/2"  
 27mmØ - 140g



**Kirk Mallets**  
**F9-330** 19cm 7 1/2"  
 38mmØ - 750g  
**F9-331** 20.4cm 8"  
 Head diameter 38.0mm,  
 Weight: 1 lb. 4 oz.  
 570 grams



**Partsch Mallets**  
**F9-032** 18cm 7"  
 22mmØ - 200g



**Lucas Mallets**  
**F9-033** 19mmØ - 220g  
**F9-034** 25mmØ - 260g  
 19cm 7 1/4"



**Mallet Mallets**  
**F9-035** 19cm 7 1/4"  
 250mmØ - 205g  
 Solid steel, with  
 plastic faces



**Cottle Mallets**  
**F9-036** 18.5cm 7 1/4"  
 30mmØ - 240g  
 1 side flat /  
 1 side convex





**Solid Copper Head Mallet**  
**F9-037** 16.5cm 6 1/2"  
 Solid. Head diameter  
 20mm 3/4"



**Nylon Head Mallet**  
**F9-038** 19.0cm 7 1/2"  
 Head diameter 25.4mm,  
 7.76 oz.  
**F9-039** 19.5cm 7 5/8"  
 Head diameter 3cm 1 1/4"  
 Weight 11 oz



**Extra 1 1/4" Nylon Face**  
**FOR F9-039**  
**F9-040** Head diameter  
 3cm 1 1/4"



**Combination Mallet**  
**F9-041** 19.5cm 7 5/8"  
 Solid. Head diameter 32.0mm,  
 Weight: 12 cz 340 grams.  
 Head weight: 8 cz 227 grams



**Bergmann Mallets**  
**F9-042**  
 24.5cm 9 3/4"  
 45mmØ - 300g



**Ombredanne Mallets**  
**F9-043**  
 24cm 9 1/2"  
 40mmØ - 550g



**Heath Mallets**  
**F9-044** 18cm 7"  
 40mmØ - 700g  
**F9-045** 20cm 8"  
 45mmØ - 1000g



**Williger Mallets**  
**F9-046** 28mmØ - 340g  
**F9-047** 30mmØ - 400g  
 24cm 9 1/2"  
 Lead filled

*Hammer*  
*Mallets*
*Martillos*  
*Martelli*

**Nylon Caps Left & Right  
FOR F9-048 (PAIR)**  
**F9-049**  
 1" (2.5cm)

**Mallet, Lightweight**  
**F9-048** 19.0cm 7 1/2"  
 Stainless Steel and Aluminum  
 Head diameter 25.0mm  
 Weight 7 oz 200 grams  
 Head Weight: 4 oz 113 grams



**Mallet #49**  
**F9-050** 19.5cm 7 3/4"  
 Head diameter 22.0mm  
 Weight: 7 oz 200 grams  
 Head Weight: 5oz/150 grams



**Mallet**  
**F9-051** 19.0cm 7 1/2"  
 Head diameter 26.0mm  
 Weight 11 oz 315 grams  
 Head Weight: 6 oz 170 grams



**Heath Mallet, Heavyweight**  
**F9-052** 19.0cm 7 1/2"  
 Head diameter 40.0mm  
 Weight 2 lbs. (907 grams)  
 Head Weight: 23 oz (667 grams)



**Orthopedic Mallet**  
**F9-053** 27.5cm 10 3/4"  
 Lightweight  
 Solid, Head diameter 35.0mm  
 Weight 2 lbs. (907 grams)  
 Head Weight: 1 lb. (454 grams)



**Orthopedic Mallet**  
**F9-054** 28.0cm 11"  
 Heavyweight  
 Solid, Head diameter 50.0mm  
 Head Weight: 2 lb. (900 grams)



**Ortho Mallets**  
**F9-055** 26.5 cm 10 1/2"  
 (450g)



## BONE CHISELS & GOUGES

*Knochenmeißel*

*Cineles, gubias*

*Ciseaux-burins, gouges*

*Scalpell, scirtli*



**Osteotome**  
13.5cm 5 1/4"  
F9-056 8mm  
F9-057 10mm  
F9-058 12mm  
F9-059 14mm  
F9-060 16mm



**Chisel**  
13.5cm 5 1/4"  
F9-061 8mm  
F9-062 10mm  
F9-063 12mm  
F9-064 14mm  
F9-065 16mm



**Gouge**  
13.5cm 5 1/4"  
F9-056 3mm  
F9-057 10mm  
F9-058 12mm  
F9-059 14mm  
F9-070 16mm



**Lucas Chisel**  
16cm 6 1/4"  
F9-071 3mm  
F9-072 4mm  
F9-073 5mm  
F9-074 6mm



**Lucas Gouge**  
16cm 6 1/4"  
F9-075 3mm  
F9-076 4mm  
F9-077 5mm  
F9-078 6mm



**U.S. Army Pattern Chisel**  
16.5cm 6 1/2"  
F9-079 6 mm width  
F9-080 12 mm width  
F9-081 18 mm width



**Alexander Chisel**  
18cm 7"  
F9-082 4mm  
F9-083 6mm  
F9-084 8mm  
F9-085 10mm  
F9-086 12mm  
F9-087 14mm



**Alexander Gouge**  
18cm 7"  
F9-088 4mm  
F9-089 6mm  
F9-090 8mm  
F9-091 10mm  
F9-092 12mm  
F9-093 14mm



**Partsch Chisel**  
11.5cm 4 1/2"  
F9-094 2mm  
F9-095 3mm  
F9-096 4mm  
F9-097 5mm  
F9-098 7mm  
F9-099 9mm

**Partsch Chisel**  
13.5cm 5 1/4"  
F9-100 2mm  
F9-101 3mm  
F9-102 4mm  
F9-103 6mm  
F9-104 7mm  
F9-105 8mm

**Partsch Chisel**  
17.5cm 6 3/4"  
F9-106 2mm  
F9-107 3mm  
F9-108 4mm  
F9-109 6mm  
F9-110 7mm  
F9-111 8mm



**Partsch Gouge**  
11.5cm 4 1/2"  
F9-112 2mm  
F9-113 3mm  
F9-114 4mm  
F9-115 6mm  
F9-116 7mm  
F9-117 8mm

**Partsch Gouge**  
13.5cm 5 1/4"  
F9-118 2mm  
F9-119 3mm  
F9-120 4mm  
F9-121 6mm  
F9-122 7mm  
F9-123 8mm

**Partsch Gouge**  
17.5cm 6 3/4"  
F9-124 2mm  
F9-125 3mm  
F9-126 4mm  
F9-127 6mm  
F9-128 7mm  
F9-129 8mm



**Straight**  
**F9-130** 09 mm  
**F9-131** 14 mm  
**F9-132** 19 mm  
**F9-133** 25 mm  
**Curved**  
**F9-134** 06 mm  
**F9-136** 14 mm  
**F9-136** 19 mm  
**F9-137** 25 mm

**Smith Peterson Gouge**  
20 cm, 8"



**Straight**  
**F9-138** 06 mm  
**F9-139** 09 mm  
**F9-140** 13 mm  
**F9-141** 16 mm  
**F9-142** 19 mm  
**F9-143** 25 mm  
**F9-144** 32 mm  
**Curved**  
**F9-145** 06 mm  
**F9-146** 09 mm  
**F9-147** 13 mm  
**F9-148** 16 mm  
**F9-149** 19 mm  
**F9-150** 25 mm  
**F9-151** 32 mm

**Smith Peterson Osteotome**  
20 cm, 8"



**Straight**  
**F9-152** 10 mm  
**F9-153** 15 mm  
**F9-154** 20 mm  
**F9-155** 25 mm  
**Curved**  
**F9-156** 10 mm  
**F9-157** 15 mm  
**F9-158** 20 mm  
**F9-159** 25 mm

**Stille Gouge**  
20 cm, 8"



**Stille**  
20 cm, 8"

**Chisel's**  
**F9-160** 10 mm  
**F9-161** 12 mm  
**F9-162** 15 mm  
**F9-163** 20 mm  
**F9-164** 25 mm  
**Osteotome**  
**F9-165** 10 mm  
**F9-166** 12 mm  
**F9-167** 15 mm  
**F9-168** 20 mm  
**F9-169** 25 mm

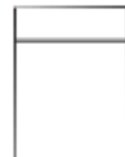

10 mm  
**F9-170**

15 mm  
**F9-171**

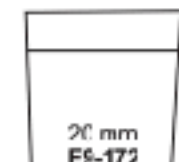

20 mm  
**F9-172**

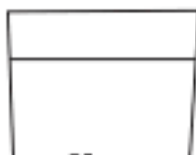

25 mm  
**F9-173**

**Stille Chisel**  
20 cm, 8"



**Stille Osteotome**  
20 cm, 8"



10 mm  
**F9-174**

15 mm  
**F9-175**



20 mm  
**F9-176**



25 mm  
**F9-177**



## BONE CHISELS & GOUGES

Knochenmeißel

Cineles, gubias

Ciseaux-burins, gouges

Scalpelli, sgratti



### Lexer Osteotome

22 cm, 8 3/4"

- F9-178 7 mm
- F9-179 10 mm
- F9-180 12 mm
- F9-181 15 mm
- F9-182 20 mm
- F9-183 25 mm
- F9-184 30 mm

### Lexer Modif. Osteotome

20 cm, 11 1/4"

- F9-185 7 mm
- F9-186 10 mm
- F9-187 12 mm
- F9-188 15 mm
- F9-189 20 mm
- F9-190 25 mm
- F9-191 30 mm



### Lexer Modif. Chisel

29 cm, 11 1/2"

- F9-192 7 mm
- F9-193 10 mm
- F9-194 12 mm
- F9-195 15 mm
- F9-196 20 mm
- F9-197 25 mm
- F9-198 30 mm

### Lexer Chisel

22 cm, 8 3/4"

- F9-199 7 mm
- F9-200 10 mm
- F9-201 12 mm
- F9-202 15 mm
- F9-203 20 mm
- F9-204 25 mm
- F9-205 30 mm



### Lexer Gouge

25 mm, 10"

- F9-206 7 mm
  - F9-207 10 mm
  - F9-208 15 mm
- Straight



### Lexer Gouge

25 mm, 10"

- F9-209 7 mm
  - F9-210 10 mm
  - F9-211 15 mm
- Curved



### Lexer Osteotome Flat

22 cm, 8 3/4"

- F8-212 10 mm
- F8-213 15 mm
- F8-214 20 mm
- F8-215 25 mm



### Lexer Gouge

Tuffnel Handle

22 cm, 8 3/4"

- F8-216 10 mm
- F8-217 15 mm
- F8-218 20 mm
- F8-219 25 mm

*Krochenmeißel*
*Cineles, gubins*
*Ciseaux-burins, gouges*
*Scalpelli, sgorbi*

**Mini Lexer Osteotome**  
F9-220  
18 cm, 7"



**Mini Lexer Chisel**  
F9-221  
18 cm, 7"  
Hollow



**Capener Osteotome**  
With Tuffnel Handle  
25cm 10"  
F9-222 10mm  
F9-223 12mm  
F9-224 15mm  
F9-225 20mm  
F9-226 25mm  
F9-227 30mm  
Straight



**Capener Osteotome**  
With Tuffnel Handle  
25cm 10"  
F9-228 10mm  
F9-229 12mm  
F9-230 15mm  
F9-231 20mm  
F9-232 25mm  
F9-233 30mm  
Curved



**Capener Chisels**  
With Tuffnel Handle  
25cm 10"  
F9-234 6mm  
F9-235 8mm  
F9-236 10mm  
F9-237 12mm  
F9-238 15mm  
F9-239 20mm  
F9-240 25mm  
F9-241 30mm  
Straight



**Capener Osteotome**  
With Tuffnel Handle  
25cm 10"  
F9-242 6mm  
F9-243 8mm  
F9-244 10mm  
F9-245 12mm  
F9-246 15mm  
F9-247 20mm  
F9-248 25mm  
F9-249 30mm  
Curved

**Lambotte Osteotome**

25cm 9 3/4"

- F9-250 6mm
- F9-251 8mm
- F9-252 10mm
- F9-253 13mm
- F9-254 15mm
- F9-255 20mm
- F9-256 25mm
- F9-257 30mm
- F9-258 38mm
- F9-259 44mm
- F9-260 50mm

Straight

**Lambotte Osteotome**

25cm 9 3/4"

- F9-261 6mm
- F9-262 8mm
- F9-263 10mm
- F9-264 13mm
- F9-265 15mm
- F9-266 20mm
- F9-267 25mm
- F9-268 30mm
- F9-269 38mm
- F9-270 44mm
- F9-271 50mm

Curved

**Mini-Lambotte Osteotome**

12.5cm 5"

- F9-272 3mm
- F9-273 4mm
- F9-274 5mm
- F9-275 3mm
- F9-276 10mm
- F9-277 12mm
- F9-278 15mm

Straight

**Mini-Lambotte Osteotome**

17cm 6 3/4"

- F9-279 3mm
- F9-280 4mm
- F9-281 6mm
- F9-282 8mm
- F9-283 10mm
- F9-284 12mm
- F9-285 15mm

Straight

**Lambotte Osteotome**

12.5cm, 5" Straight

- F9-286 2mm tip width
- F9-287 4mm tip width
- F9-288 6mm tip width
- F9-289 8mm tip width
- F9-290 10mm tip width
- F9-291 12mm tip width
- F9-292 15mm tip width

**Hex Handle Osteotome**

15cm, 6" Straight

- F9-293 2mm tip width
- F9-294 3mm tip width
- F9-295 4mm tip width
- F9-296 5mm tip width
- F9-297 6mm tip width
- F9-298 7mm tip width
- F9-299 9mm tip width
- F9-300 10mm tip width

**Cottle Osteotome**

13.5cm, 7 1/4" Straight

- F9-301 4mm tip width
- F9-302 6mm tip width
- F9-303 9mm tip width
- F9-304 12mm tip width

**Anderson-Niever Osteotome**

20.4cm 8"

- F9-305 Curved right
- F9-306 Curved left
- F9-307 Straight



**Stille**  
20cm 8"

**Stille Chisel**

F9-300 10mm  
F9-309 15mm  
F9-310 20mm  
F9-311 25mm  
Straight

**Stille Osteotome**

F9-312 10mm  
F9-313 15mm  
F9-314 20mm  
F9-315 25mm  
Straight

**Stille Osteotome**

F9-316 10mm  
F9-317 15mm  
F9-318 20mm  
F9-319 25mm  
Curved

**Stille Gouge**

F9-320 10mm  
F9-321 15mm  
F9-322 20mm  
F9-323 25mm  
Straight

**Stille Gouge**

F9-324 10mm  
F9-325 15mm  
F9-326 20mm  
F9-327 25mm  
Curved



**Smith-Petersen**  
20cm 8"

**Smith-Petersen osteotome**

F9-328 6mm  
F9-329 9mm  
F9-330 13mm  
F9-331 16mm  
F9-332 19mm  
F9-333 25mm  
F9-334 32mm  
Straight

**Smith-Petersen Osteotome**

F9-335 6mm  
F9-336 9mm  
F9-337 13mm  
F9-338 16mm  
F9-339 19mm  
F9-340 25mm  
F9-341 32mm  
Curved

**Smith-Petersen Gouge**

F9-342 9mm  
F9-343 16mm  
F9-344 19mm  
F9-345 25mm  
Straight

**Smith-Petersen Gouge**

F9-346 9mm  
F9-347 16mm  
F9-348 19mm  
F9-349 25mm  
Curved





*Knochenmeißel*
*Cineles, gubins*
*Ciseaux-burins, gouges*
*Scalpelli, sgorbi*

**Freer Gouge**  
F9-350 15cm 6"  
06mm



**Freer Chisel**  
F9-351 13cm 5 1/4"  
04mm



**Shoulder Penetrating Gouge**  
F9-352  
21.6cm 8 1/2"  
Straight, 3mm distal tip



**Ballenger Chisel**  
F9-353 04mm  
F9-354 06mm  
F9-355 08mm  
16cm 6 1/4"



**Mannerfelt Moccif.**

**Osteotomes**  
F9-356 04mm  
F9-357 06mm  
F9-358 08mm  
15.5cm 6"

**Gouge**  
F9-359 (3mm  
15.5cm 6"



**Kilian, Septum Gouge**  
F9-360 18cm 8 1/4"  
05mm



**Kilian-Claus Septum Gouge**  
F9-361 16cm 6 1/4"  
05mm



**Cottle Osteotome**  
F9-362 07mm  
F9-363 12mm  
15cm 6"



**Cottle Osteotome**  
F9-364 19cm 7 1/2"  
04mm



**Cottle Osteotome with depth markings**  
F9-365 16cm 7"  
08mm

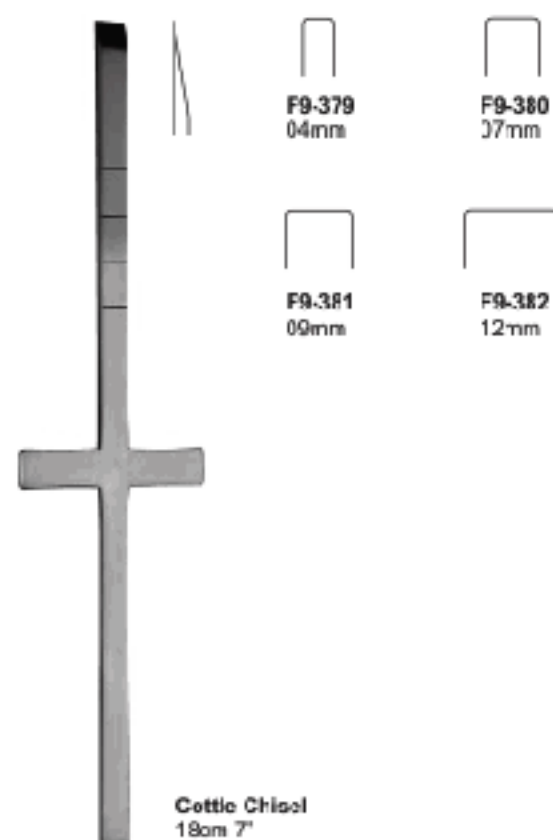
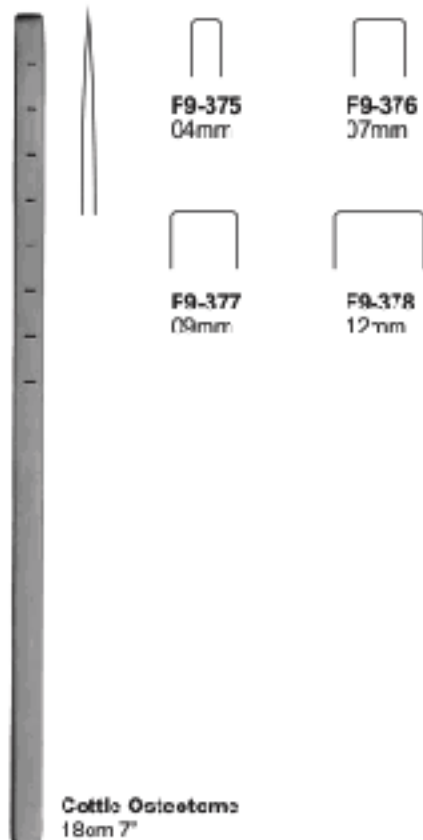
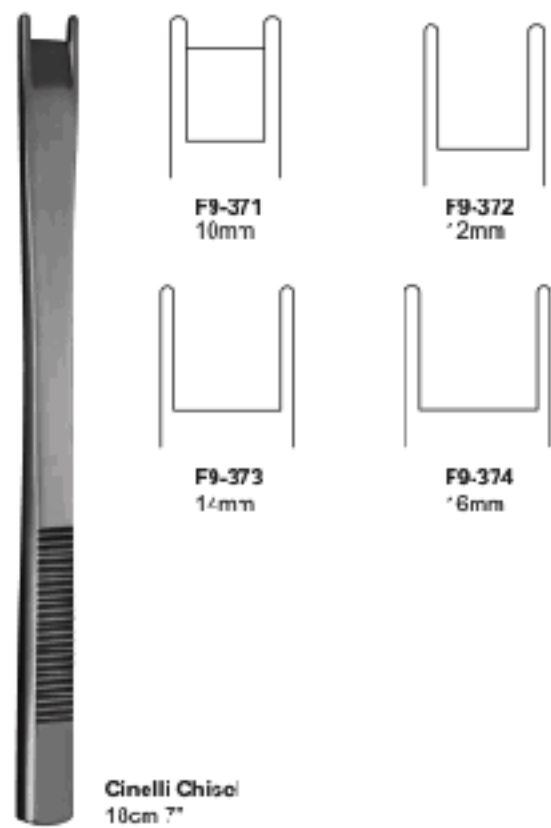
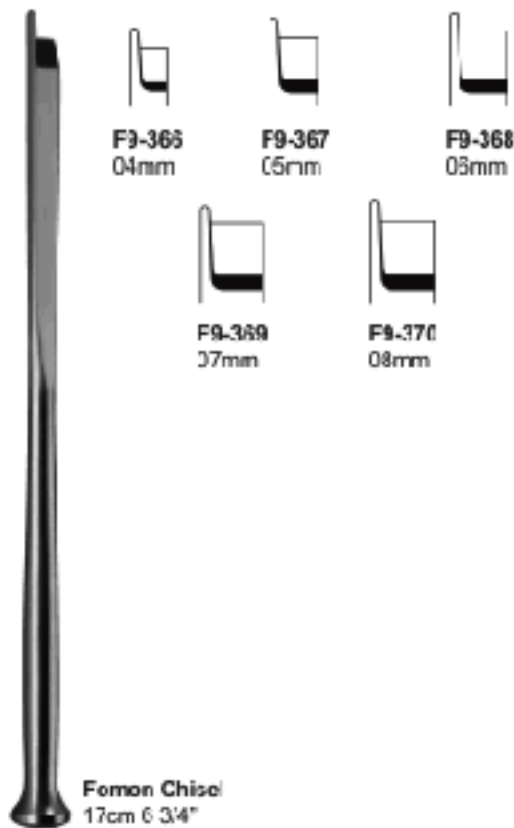



*Meißel zur Nasenplastik*

*Osteotomes, ciseaux-turins pour rhinoplastique*

*Circeles para rinoplastica*

*Scalpell per plastica nasale*



**Sheehan osteotome**  
16cm 6 1/4"



**F9-383**  
2mm



**F9-384**  
4mm



**F9-385**  
6mm



**F9-386**  
8mm



**F9-387**  
10mm



**F9-388**  
12mm



**F9-389**  
15mm



**F9-390**  
18mm



**Silver Rhinoplastic Chisel**



**F9-391**  
18cm 7"  
Straight:



**F9-392**  
18cm 7"  
right



**F9-393**  
18cm 7"  
Left



**Noivart Anderson osteotome**



**F9-394**  
20cm 8"  
Straight



**F9-395**  
20cm 8"  
right



**F9-396**  
20cm 8"  
Left



**Obwegeser Osteotome**  
F9-397 20.5cm 8 1/4"  
11mm



**Obwegeser Blade osteotome**  
F9-393 7mm  
21.5cm 8 5/8"



**Obwegeser Blade osteotome**  
F9-399 10mm  
21.5cm 8 5/8"



**Bone Tamper**

- |  |   |  |
|--|---|--|
| <br><b>F9-400</b><br>15.5cm 6"<br>Head diameter<br>2mm | <br><b>F9-401</b><br>15.5cm 6"<br>Head diameter<br>3mm  | <br><b>F9-402</b><br>15.5cm 6"<br>Head diameter<br>4mm |
| <br><b>F9-403</b><br>15.5cm 6"<br>Head diameter<br>5mm | <br><b>F9-404</b><br>15.5cm 6"<br>Head diameter<br>6mm  |  |
| <br><b>F9-405</b><br>15.5cm 6"<br>Head diameter<br>8mm | <br><b>F9-406</b><br>15.5cm 6"<br>Head diameter<br>10mm |  |



- F9-407**  
2.5mm x 2.6mm
- F9-408**  
3.5mm x 3.5mm

**Pessow Bone Tamper**  
12cm 4 3/4"



- F9-409**  
3mm
- F9-410**  
5mm
- F9-411**  
8mm

**Casper Bone Tamper**  
20cm 8"



**Casper Bone Tamper**  
20cm 8"

- F9-412**  
12mm
- F9-413**  
14mm
- F9-414**  
16mm



**Bone Tamper**  
F9-415  
15.4 cm, 6"

- Tip Size  
2 mm  
3 mm  
4 mm  
5 mm  
6 mm  
8 mm  
10 mm

Scharfe Löffel  
Curettes tranchantes

cucharillos cortantes  
Cucchiai taglianti



**Volkmann  
Bone Curette**

**F9-416**  
17 cm, 7"  
0000

**F9-419**  
17 cm, 7"  
0

**F9-422**  
17 cm, 7"  
3

**F9-417**  
17 cm, 7"  
000

**F9-420**  
17 cm, 7"  
1

**F9-423**  
17 cm, 7"  
4

**F9-418**  
17 cm, 7"  
00

**F9-421**  
17 cm, 7"  
2

**F9-424**  
17 cm, 7"  
5

**F9-426**  
17 cm, 7"  
6



**Schade  
Bone Curette**  
17 cm, 6 3/4"

**F9-426**  
17 cm, 7"  
000

**F9-429**  
17 cm, 7"  
1

**F9-427**  
17 cm, 7"  
00

**F9-430**  
17 cm, 7"  
2

**F9-428**  
17 cm, 7"  
0

**F9-431**  
17 cm, 7"  
3

**F9-432**  
17 cm, 7"  
4



**Ernst  
Bone Curette**

**F9-433**  
17 cm, 7"  
000

**F9-435**  
17 cm, 7"  
0

**F9-437**  
17 cm, 7"  
2

**F9-439**  
17 cm, 7"  
4

**F9-434**  
17 cm, 7"  
00

**F9-436**  
17 cm, 7"  
1

**F9-438**  
17 cm, 7"  
3

**F9-440**  
17 cm, 7"  
5

**F9-441**  
17 cm, 7"  
6



**Spratt Bone Curette  
/ Hollow Handle**

**F9-442**  
16.5 cm, 6 1/2"  
00000

**F9-445**  
16.5 cm, 6 1/2"  
00

**F9-448**  
16.5 cm, 6 1/2"  
2

**F9-443**  
16.5 cm, 3 1/2"  
0000

**F9-446**  
16.5 cm, 3 1/2"  
0

**F9-449**  
16.5 cm, 3 1/2"  
3

**F9-444**  
16.5 cm, 6 1/2"  
303

**F9-447**  
16.5 cm, 6 1/2"  
1

**F9-460**  
16.5 cm, 6 1/2"  
4

**F9-461**  
16.5 cm, 6 1/2"  
5



**Schroeder  
Bone Curette**  
Sharp / rigid



**F9-452**  
30.0 cm, 12"  
1



**F9-454**  
30.0 cm, 12"  
3



**F9-456**  
30.0 cm, 12"  
5



**F9-453**  
30.0 cm, 12"  
2



**F9-455**  
30.0 cm, 12"  
4



**F9-457**  
30.0 cm, 12"  
6



**Simon  
Bone Curette**  
Sharp / rigid



**F9-458**  
24.0 cm, 9 1/2"  
0000



**F9-460**  
24.0 cm, 9 1/2"  
00



**F9-459**  
24.0 cm, 9 1/2"  
000



**F9-461**  
24.0 cm, 9 1/2"  
0



**F9-462**  
25.0 cm, 9 3/4"  
1



**F9-465**  
25.0 cm, 9 3/4"  
4



**F9-463**  
25.0 cm, 9 3/4"  
2



**F9-466**  
25.0 cm, 9 3/4"  
5



**F9-464**  
25.0 cm, 9 3/4"  
3



**F9-467**  
25.0 cm, 9 3/4"  
5

**Volkmann  
Curette**  
 Oval / Oval

**F9-460**  
 12 cm, 5 1/4"

**F9-469**  
 14 cm, 5 1/2"

**F9-470**  
 17 cm, 6 1/2"

**Volkmann  
Curette**  
 Round / Oval

**F9-471**  
 13 cm, 5 1/4"

**F9-472**  
 16 cm, 6 1/4"

**F9-473**  
 20 cm, 8"

**Curette  
F9-474**  
 21cm 8 1/4"  
 round / oval

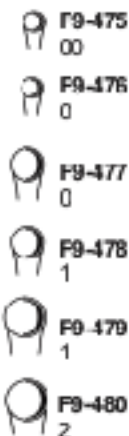
**Martini  
Curette**  
 13.5 cm, 5 1/4"

**F9-475**  
 00

**F9-476**  
 0

**F9-477**  
 0

**F9-478**  
 1

**F9-479**  
 1

**F9-480**  
 2

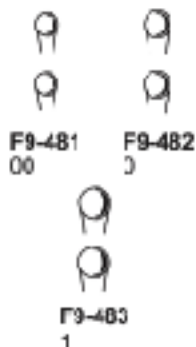
**Martini  
Curette**  
 15.5 cm, 6"

**F9-481**  
 00

**F9-482**  
 0

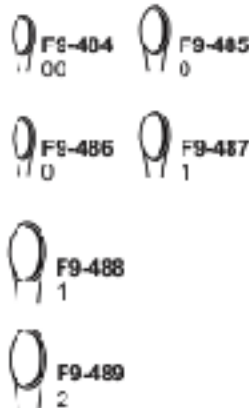
**F9-483**  
 1

**Williger  
Curette**  
 13.5 cm, 5 1/4"

**F9-484**  
 00

**F9-485**  
 0

**F9-486**  
 0

**F9-487**  
 1

**F9-488**  
 1

**F9-489**  
 2

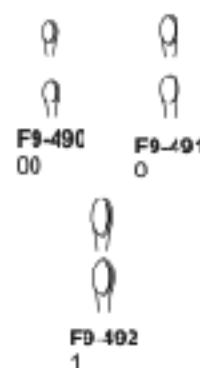
**Williger  
Curette**  
 15.5 cm, 6"

**F9-490**  
 00

**F9-491**  
 0

**F9-492**  
 1



**Jansen Curette**  
**F9-493**  
 16 cm, 6 1/4"



**Jansen Curette**  
**F9-494**  
 15 cm, 6"



**Willger Curette**  
**F9-495**  
 13.25 cm, 5 1/8"  
 Double Ended  
 n/r/c



**F9-496**  
 13 cm, 5"  
 Double Ended  
 6.2 mm & 8.7 mm  
  
**F9-497**  
 18 cm, 6 1/2"  
 Double Ended  
 7 mm & 9 mm  
  
**F9-498**  
 20 cm, 8"  
 Double Ended  
 9.1 mm & 11.1 mm



**Lucæ Curette**  
 double ended  
 10 cm, 7"



Fig. 1 R/L  
**F9-499**



Fig. 2 R/L  
**F9-500**

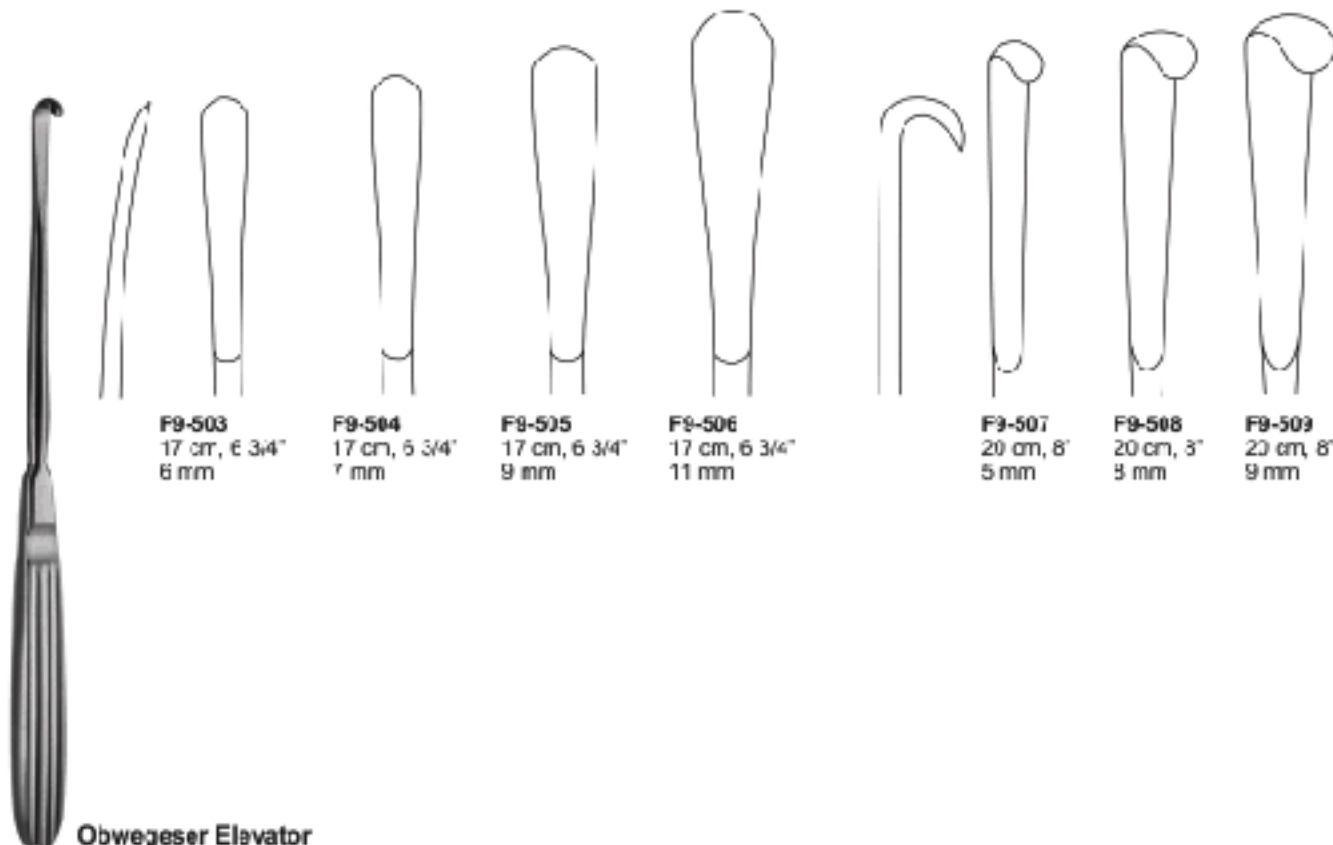

Fig. 3 R/L  
**F9-501**



Fig. 4 R/L  
**F9-502**



**F9-503**  
 17 cm, 6 3/4"  
 6 mm

**F9-504**  
 17 cm, 6 3/4"  
 7 mm

**F9-505**  
 17 cm, 6 3/4"  
 9 mm

**F9-506**  
 17 cm, 6 3/4"  
 11 mm

**F9-507**  
 20 cm, 8"  
 5 mm

**F9-508**  
 20 cm, 8"  
 3 mm

**F9-509**  
 20 cm, 8"  
 9 mm

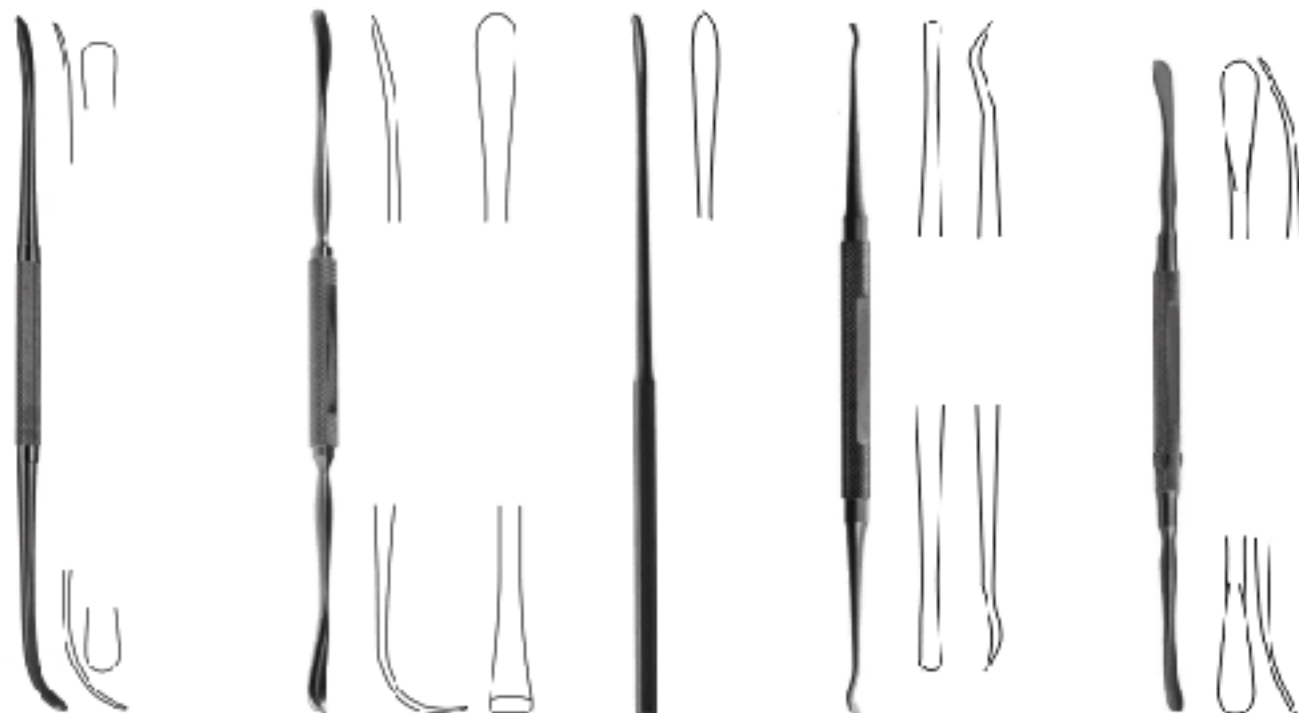
**Obwegeser Elevator**

**Obwegeser-Freer  
 elevator**  
**F9-510**  
 21 cm, 8 1/4"

**Obwegeser-Freer  
 elevator**  
**F9-511**  
 21 cm, 8 1/4"

**Sachs Nerve  
 elevator**  
**F9-512**  
 18.5 cm, 7 3/8"  
 3 mm blunt

**Kleinert Kurz  
 Elevator and Dissector**  
**F9-513**  
 19.5 cm, 7 3/8"  
 2 mm x 3 mm Sharp ends

**Freer Elevator**  
**F9-514**  
 18.5 cm, 7 3/8"  
 double ended  
 5 mm sharp end  
 5 mm blunt end

*Raspatorien*  
*Periostótomos*
*Pugines-raspatories*  
*Periostotomi*

**Obwegeser Needle**  
**F9-515**  
 17.5 cm, 7"



**Obwegeser Needle**  
**F9-516**  
 25 cm, 9"



**Obwegeser Needle**  
**F9-517**  
 18 cm, 7"



**Obwegeser Needle**  
**F9-518**  
 14 cm, 5 1/2"



**Doyen Rib Raspatory**  
 17 cm, 7"



**F9-519**  
 Right Curved  
 For Adults

**F9-520**  
 Right Curved  
 For Children



**Doyen Rib Raspatory**  
 17 cm, 7"



**F9-521**  
 Left Curved  
 For Adults

**F9-522**  
 Left Curved  
 For Children



**Sedillot Elevator**  
**F9-523** 18.5cm, 7 1/4"  
**F9-524** 21.0cm, 8 1/4"

*Raspatoires*  
*Periostótomos*
*Rignes-raspatoires*  
*Periostotomi*

**Grego Periosteal Elevator**  
**F9-525**  
 15.5cm, 6"



**Williger Elevator**  
**F9-526** 13cm, 5"  
 5mm



**Williger Elevator**  
**F9-527** 4mm  
**F9-528** 6mm  
 16cm, 6 1/4"



**Williger Elevator**  
**F9-529**  
 16cm, 6 1/4"  
 5mm



**Williger Elevator**  
**F9-530**  
 16cm, 6 1/4"  
 6.5mm



**Farabeuf-Collin Elevator**  
**F9-531**  
 16cm, 6 1/4"  
 11mm  
 Straight



**Farabeuf-Collin Elevator**  
**F9-532**  
 16cm, 6 1/4"  
 11mm  
 Curved



**Farabeuf Elevator**  
**F9-533**  
 15cm, 6"  
 Straight



**Farabeuf Elevator**  
**F9-534**  
 15cm, 6"  
 Curved



**Lambotte Elevator**  
**F9-535** 5mm  
**F9-536** 10mm  
**F9-537** 15mm  
**F9-538** 20mm  
**F9-539** 25mm  
 21cm, 8 1/4" Straight

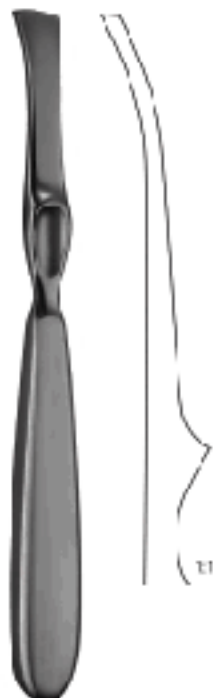

**Lambotte Elevator**  
**F9-540** 5mm  
**F9-541** 10mm  
**F9-542** 15mm  
**F9-543** 20mm  
**F9-544** 25mm  
 21cm, 8 1/4" Curved



**Hohmann  
Bone Elevator  
F9-545 43mm  
24.5 cm, 9 1/2"**

**Hohmann  
Bone Elevator  
F9-545 22mm  
26cm, 10 1/4"**

**Hohmann  
Bone Elevator  
F9-547 33mm  
29cm, 11"**

**Hohmann  
Bone Elevator  
F9-548 24mm  
26.5cm, 10 1/2"**

**Hohmann  
Bone Elevator  
F9-549 22mm  
26cm, 10 1/4"**

*Knochenhebel*  
*Leviers c os*
*Elevadores para huesos*  
*Elevatori per ossa*

**Capsule Retractor**  
**F9-550** 25.5cm 10"  
 3 sharp-pronged,  
 22mm width blade



**Bristow-Bankart  
 Humeral Retractor**  
**F9-551** 19.0cm 7 1/2"  
 Double-pronged,  
 25mm width x 102mm  
 depth blade



**Bristow-Bankart Soft  
 Tissue Retractor**  
**F9-552** 20.0cm 7 7/8"  
 3-pronged  
 21mm width blade,



**Humeral Head Retractor**  
**F9-553** 22.0cm 8 3/4"  
 18mm width blade



**Hohmann Bone Elevator**  
**F9-554** 22cm, 8 3/4"  
 05mm width blade  
**F9-555** 23.0cm 9"  
 10mm width blade

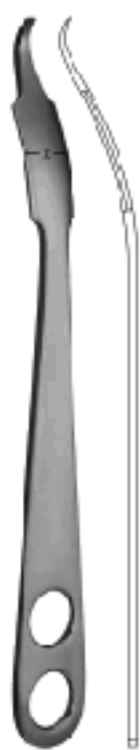

**Hohmann Bone Elevator**  
**F9-556** 24cm, 9 1/2"  
 18mm



**Hohmann Bone Elevator**  
**F9-557** 24cm, 9 1/2" 70mm  
**F9-558** 28.5cm 11 1/4" 35mm width blade  
**F9-559** 33.0cm 13" 40mm width blade



**Hohmann Long Shank  
 Retractor**  
**F9-560** 23.0cm 9"  
 43mm width blade

**Mini-Hohmann  
Bone Elevator**

**F9-561**  
 16cm, 6 1/4"  
 6mm width blade

**F9-562**  
 16cm, 6 1/4"  
 3mm width blade

**Hohmann  
Bone Lever  
F9-563**  
 15 cm, 6"

**Hohmann  
Bone Lever  
F9-564**  
 5.4 cm, 6"  
 Short tip

**Hohmann Retractor  
F9-565**  
 15.0cm 6"  
 15mm width blade

**Hayes Hand Retractor  
F9-566** 16.0cm 6 1/4"  
 3mm width blade

**Hayes Hand Retractor  
F9-567** 15.0cm 6"  
 3mm width blade

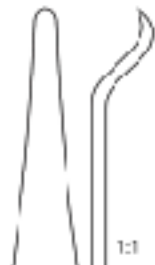
**Bone Lever**

**F9-568** 14cm, 5 1/2"  
 2.8mm

**F9-569** 14cm, 5 1/2"  
 4.5mm

**F9-570** 14cm, 5 1/2"  
 6mm

**Bristow Bone Lever  
F9-571** 23cm, 9"

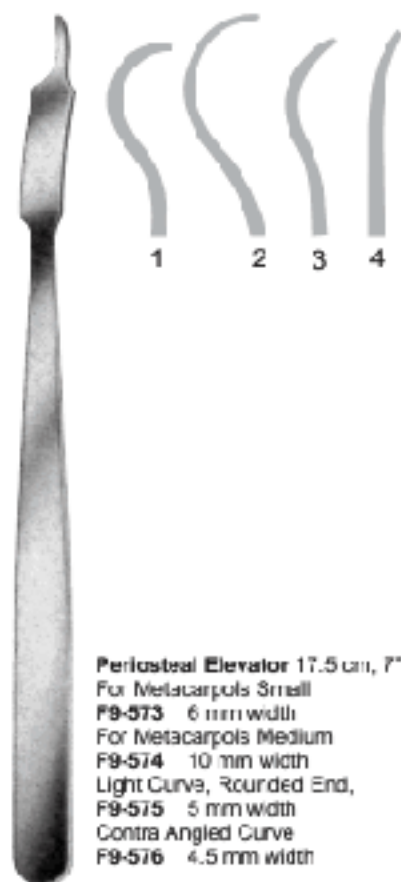
**Lane Bone Lever  
F9-572**  
 21cm, 8 1/4"

*Knochenhebel*  
*Leviers c os*
*Flexiones para huesos*  
*Elevatori per ossa*

**Periosteal Elevator** 17.5 cm, 7"  
 For Metacarpals Small  
**F9-573** 6 mm width  
 For Metacarpals Medium  
**F9-574** 10 mm width  
 Light Curve, Rounded End,  
**F9-575** 5 mm width  
 Contra Angled Curve  
**F9-576** 4.5 mm width



**Hohmann Retractor**  
**F9-577** 13 cm, 7"  
 Small, width 6 mm  
 short, narrow tip

**Hohmann Retractor**  
**F9-578** 10 cm, 7"  
 Small, width 8 mm  
 short, narrow tip



**Hohmann Retractor**  
**F9-579** 12.5 cm, 5"  
 Finger Ring handle,  
 16mm width blade



**Hohmann-Wiliger**  
**Retractor**  
**F9-580** 18 cm 6 1/4"

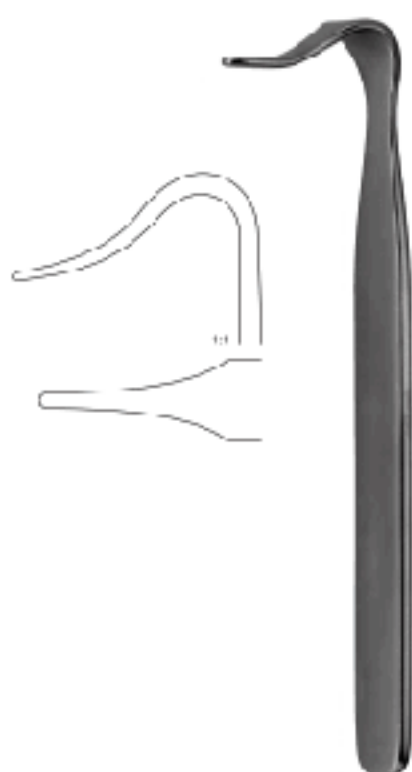

**Blount Retractor**  
**F9-581**  
 17.5 cm, 7"



**Taylor Retractor**  
 16.5 cm, 6 1/2"  
**F9-582** a=75mm - h=30mm  
**F9-583** a=100mm - h=30mm

*Knochenhebel*  
*Leviers e os*
*Fleurdoras para huesos*  
*Clevatori per ossa*

**Cushing Vein Retractor**  
**F9-584** 22.5 cm, 9"  
 with fenestrated handle  
 Blade 12 mm width x 10 mm



**Cushing Decompression Retractor**  
**F9-585** 21.5 cm, 8 1/2"  
 with fenestrated blade and handle  
 Blade 13 mm width x 22 mm



**Scoville Nerve Retractor**  
**F9-586**  
 24 cm, 9 1/2", 7 mm  
 straight



**Scoville Nerve Retractor**  
**F9-587**  
 24 cm 9 1/2", 7 mm  
 angled

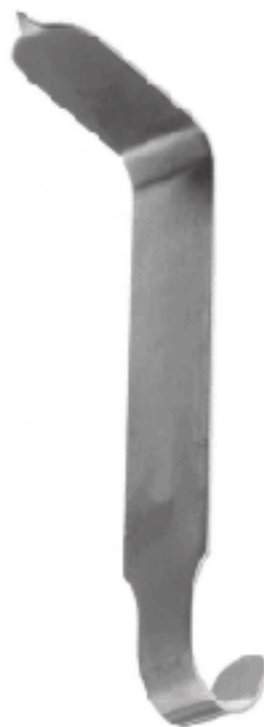

**Taylor Retractor**  
 17 cm, 6 3/4"  
**F9-588** 30 x 75 mm  
**F9-589** 30 x 100 mm



**Hibbs Retractor**  
**F9-590** 25 x 76 mm, 23 cm, 9"  
**F9-591** 25 x 100 mm, 24 cm, 9 1/2"



**Meyering Retractor**  
**F9-592** 16 x 63 mm, 20 cm, 8"  
**F9-593** 26 x 75 mm, 23 cm, 9"  
**F9-594** 60 x 103 mm, 24 cm, 9 1/2"



*Meniskotome*
*Bisturies peric. meniscus*
*Bisturries a menisques*
*Bisturi per menisco*

**Bircher Meniscotomy Knife**  
**F9-595**  
 19cm 7 1/2"



**Maison Meniscotomy Knife**  
**F9-596**  
 22 cm, 9"



**Downing Cartilage Knife**  
**F9-597** 25.5cm 10"  
 Curved tip, Straight shaft



**Smillie Meniscotomy Knife**  
**F9-598**  
 16cm 6 1/4" Straight shaft,  
 Blade tip width is 7.8mm  
 Straight tip



**Smillie Meniscotomy Knife**  
**F9-599**  
 16cm 6 1/4" curved shaft,  
 Blade tip width is 7.8mm  
 Curved left tip



**Smillie Meniscotomy Knife**  
**F9-600**  
 15cm 6 1/4" Curved shaft,  
 Blade tip width is 7.8mm  
 Curved left tip



**Nail Extracting Forceps**  
**F9-601**  
 14 cm, 5 1/2"



**Nail Extracting Forceps**  
**F9-602**  
 14.5 cm, 5 3/4"



**Finger Nail Drill**  
 with 3 drill points  
**F9-603**

Frill points only

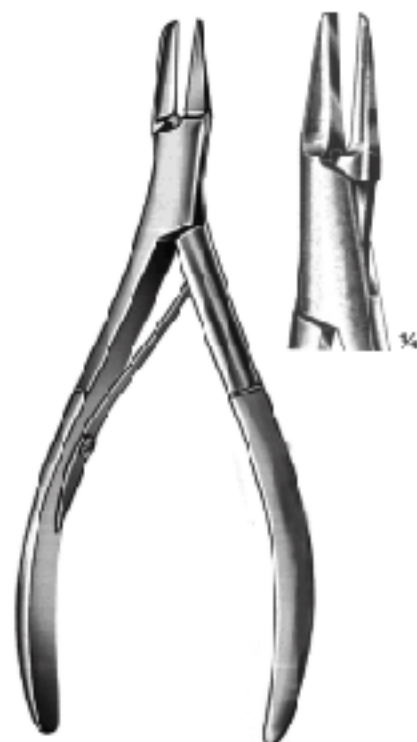

**Nail Splitting Forceps**  
**F9-607**  
 13.5 cm, 5 1/4"



**Ring Cutter**  
**F9-608**  
 17 cm, 6 3/4"



**Ring Cutter**  
**F9-610**  
 17 cm, 6 3/4"



**Tendon Tunelling Forceps**  
**F9-612**  
 13cm 5"



**F9-613**  
 15cm 6"

**Tendon Tunelling Forceps**

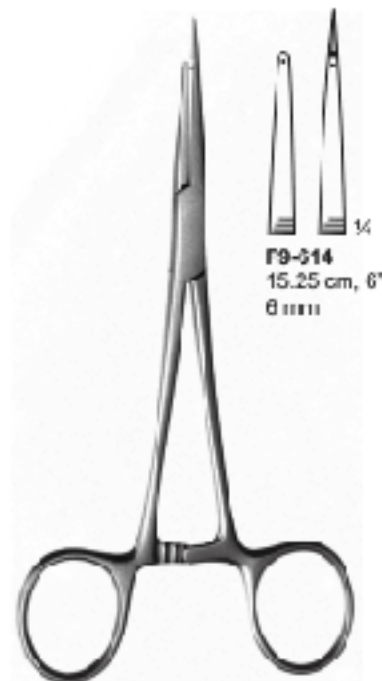

**F9-614**  
 15.25 cm, 6"  
 8 111111

**Tendon Tunelling Forceps**



**Brand Tendon Forceps**  
**F9-615** 15 cm, 6"  
**F9-616** 19 cm, 7 1/2"  
**F9-617** 24 cm, 9 1/2"



**Carroll Tendon Forceps**  
**F9-618** 13 cm, 5"  
 Curved Shaft  
 2 mm x 6 mm

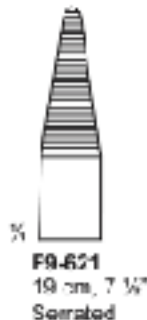

**Lead Hand**  
**F9-619**  
 Adult Size

**Needle Nose Pliers**

**Needle Nose Pliers**

**Flat Nose Plier**  
**F9-622**  
 18 cm, 7"

**Flat Nose Pliers**  
**F9-623**  
 13.5cm 5 3/8"  
 Broad, 4mm tip,

**Flat Nose Pliers**  
**F9-624**  
 13.5cm 6 1/2"  
 Combination plier and  
 cutter

**Needle Nose Pliers**  
**F9-625**  
 13.5cm 5 3/8"

**Flat Nose Pliers**  
**F9-626**  
 15cm 6" Delicate. 1.5mm tip

**K-Wire Extraction Pliers**  
**W/Screw Lock**  
**F9-627**  
 13cm 5' 3mm tip



**Flat Nose K-Wire Pliers**  
**F9-628** 14.0cm 5 1/2"  
**F9-629** 17.0cm 6 3/4"



**Nose Pliers**  
**F9-533**  
 17cm 6 3/4"



**Pin Puller W/ Groove TC**  
**F9-631**  
 14.0cm 5 1/2"



**Utility Technical Forceps Pliers**  
**F9-632** 19cm 7 1/2" adjustable



**Vital Heavy Duty Pliers TC**  
**F9-633** 22cm 8 3/4"  
 Grip Forceps, Combined with cutter



**Vital Wire Extraction Pliers T.C**  
**F9-634** 5mm  
**F9-635** 7mm  
 18cm 7"



**Wire Bending Forceps**  
**F9-636** 18.5.0cm 7 1/4"



**Flat Nose Plier**  
**F9-637** 18.5.0cm 7 1/4"  
 parallel grip, incorporated  
 cutter, for hard wires up to  
 1.6mm



**Locking Plier**  
**F9-643** 22cm 8 3/4"  
**F9-644** 26cm 10 1/4"  
**F9-645** 30cm 12"  
 Locking plier only  
**F9-646** 30cm 12"  
 with holding pins  
**F9-647** 40cm 16"  
 with extraction device



**Locking Plier**  
**F9-638** 18cm 7"  
**F9-639** 20cm 8"  
**F9-640** 24cm 9 1/2"



**Plate Bending Plier**  
**F9-641** 20cm 8"  
 for plates up to 2.7mm  
**F9-642** 24cm 9 1/2"  
 for plates up to 4mm



**Needle-Nose Locking Pliers**  
**F9-648**



**Needle-Nose Locking Pliers**  
**F9-649**



**Needle-Nose Locking Pliers**  
**F9-650**



**Flat Nosed Plier**  
**F9-651** 13 cm, 7"  
 parallel, with lateral  
 wire outtor



**Cast Spreader**  
**Model Usa**  
**F9-652** 23 cm, 9"  
 3 Prong



**Nail Extractor**  
**F9-663** 16 cm 6 1/2"  
 with Longitudinal Grove  
 (for Intramedullary Gliding Nail)

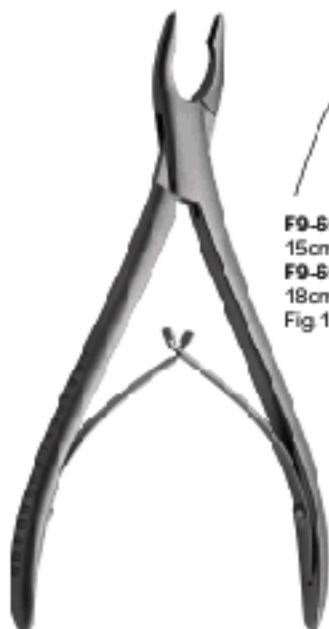

**Luer Bone Rongeur**  
Single action  
Curved, 8 x 12mm



**F9-654** 15cm 6"  
**F9-655** 18cm 7 1/8"  
Fig. 1

**F9-656** 15cm 6"  
**F9-657** 18cm 7 1/8"  
Fig. 2



**Luer Bone Rongeur**  
Single action,  
Straight, 8 x 12mm

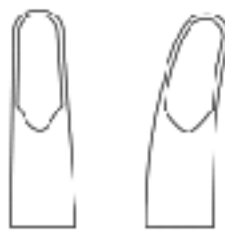

**F9-658** 17cm 6 3/4"  
Fig. 1

**F9-659** 17cm 6 3/4"  
Fig. 2



**Friedmann Bone Rongeur**  
**F9-660** 14.5cm 5 3/4"  
Single action, Curved,  
4 x 1 mm,



**Blumenthal Bone Rongeur**

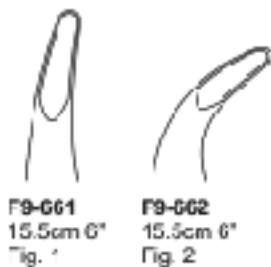

**F9-661** 15.5cm 6"  
Fig. 1

**F9-662** 15.5cm 6"  
Fig. 2



**F9-663** 15.5cm 6"  
Fig. 3



**Jasen Bone Rongeur**

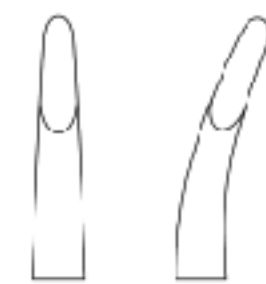

**F9-654** 18cm 7"  
Fig. 1

**F9-665** 18cm 7"  
Fig. 2



**Jansen Bone Rongeur**  
**F9-656** 19cm 7 1/2"



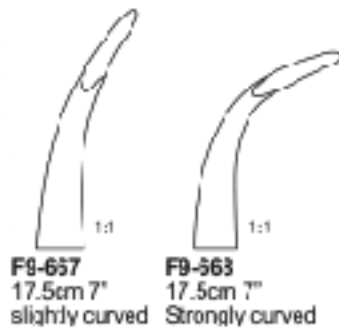

**F8-657**  
 17.5cm 7"  
 slightly curved

**F9-663**  
 17.5cm 7"  
 Strongly curved

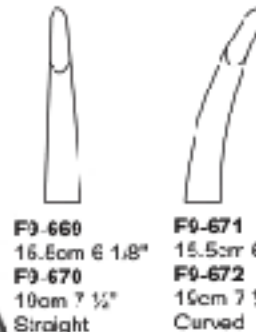
**Stellbrink Bone Rongeur**

**F9-660**  
 16.5cm 6 1/8"  
**F9-670**  
 10cm 7 1/2"  
 Straight

**F9-671**  
 15.5cm 6 1/8"  
**F9-672**  
 15cm 7 1/4"  
 Curved

**Lempert Bone Rongeur**

**Rongeur #4**  
**F9-673** 14cm 5 1/2"  
**Rongeur #4A**  
**F9-674** 16.5cm 6 1/2"  
 Single action,  
 Curved, 4 x 9mm

**Chichirelli (Blumenthal) Rongeur**  
**F9-675**  
 15cm 6"  
 Single action, Curved 45°  
 4 x 13mm

**Dean (Blumenthal) Rongeur**  
**F9-676**  
 15cm 6"  
 Single action,  
 Curved 90°, 4 x 11mm

**Dean Rongeur**  
**F9-677** 14.5cm 5 3/4"  
 Single action  
 Curved, 3mm

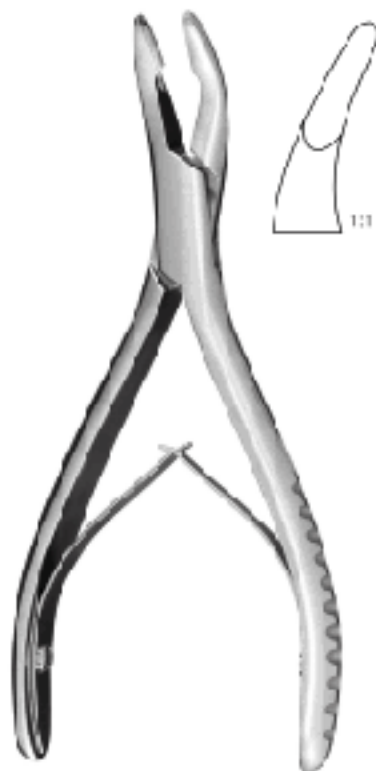

**Hartmann Bone Rongeur**  
**F9-678** 18.5cm 7 1/4"  
 Single action  
 Curved, 4 x 14mm

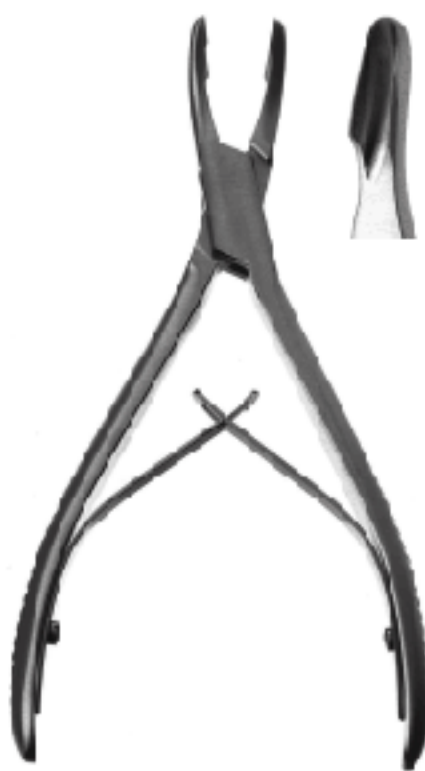

**Mead Bone Rongeur**  
**F9-679** 16.5cm 5 1/2"  
 Single action  
 Curved, 5 x 13mm



**Cleveland Bone Rongeur**  
**F9-680**  
 14cm 5 1/2"



**Cleveland Bone Rongeur**  
**F9-631**  
 17cm 6 3/4"

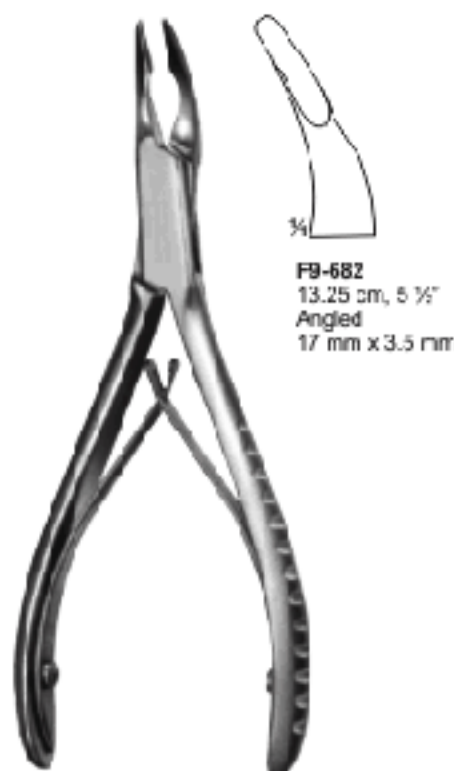

**F9-682**  
 13.25 cm, 5 1/8"  
 Angled  
 17 mm x 3.5 mm

**Universal Bone Rongeur**



**F9-683**  
 13 cm, 7"  
 Single action  
 Curved,  
 3 x 16mm

**Bone Bone Rongeur**

**F9-684**  
 15cm 6"  
 Straight

**F9-685**  
 15cm 6"  
 Curved

**Eohler Bone Rongeur**

**Zaufal-Jansen Bone Rongeur**  
**F9-686** 18cm 7"  
 Double action  
 Curved. 5x15mm

**Marquardt Bone Rongeur**  
**F9-687**  
 18cm 7"

**Beyer Bone Rongeur**  
 7" 18cm  
**F9-688** 3 x 14mm  
**F9-689** 4 x 15mm  
 Double action, Curved

**Smith-Peterson Lamincotomy Rongeur**  
**F9-690** 24cm 9 1/2"  
 Double action,  
 Straight: 3 x 16mm

**Smith-Peterson Lamincotomy Rongeur**  
**F9-691** 24cm 9 1/2"  
 Double action  
 Curved 3 x 16mm



**Ruskin Rongeur**  
**F9-662** 16cm 7 1/8" 4 x 16mm  
**F9-663** 16.5cm 7 1/4" 5 x 10mm  
 Double action, Curved on side



**Ruskin Rongeur**  
**F9-694** 18.5cm 7 1/4"  
 Double action, 6 x 16mm,  
 Straight, Curved



**Ruskin Rongeur**  
**F9-695** 15.5cm 6" Straight, 3.2mm  
**F9-696** 15cm 6" Curved, 2 x 15mm  
**F9-697** 15cm 6" Curved, 3 x 15mm  
 Double action.



**Riskin Bone Rongeur**



**F9-690** 15.5cm 6"  
**F9-699** 10cm 7"  
 Double action  
 Straight, 2 x 14mm



**F9-700** 15.5cm 6"  
**F9-701** 18cm 7"  
 Double action  
 Curved 2 x 14mm



**Mayfield Bone Rongeur**  
**F9-702** 18cm 7"



**Stille-Ruskin Bone Rongeur**



**F9-703**  
 23cm 9"  
 Curved

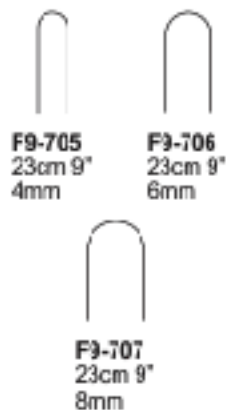

**F9-704**  
 23cm 9"  
 Straight

**Stille Bone Rongeur**

**F9-705**  
23cm 9"  
4mm

**F9-706**  
23cm 9"  
6mm

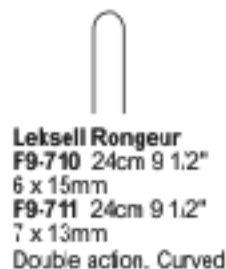
**F9-707**  
23cm 9"  
8mm

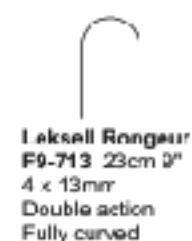
**Leksell Bone Rongeur**
**F9-708** 24.5cm 9 5/8" 5 x 13mm  
**F9-709** 24cm 9 1/2" 8 x 14.5mm  
 Double action. Curved 50°

**Leksell Rongeur**  
**F9-710** 24cm 9 1/2"  
 6 x 15mm  
**F9-711** 24cm 9 1/2"  
 7 x 13mm  
 Double action. Curved

**Leksell Rongeur**  
**F9-712** 24cm 9 1/2"  
 3 x 18mm  
 Double action. Curved

**Leksell Rongeur**  
**F9-713** 23cm 9"  
 4 x 13mm  
 Double action  
 Fully curved

**Stille Luer Rongeur Forceps**

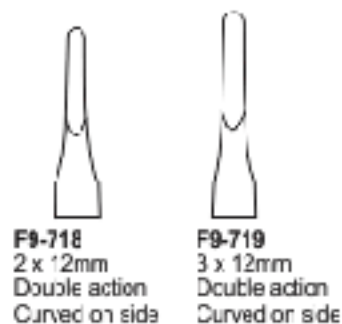
**F9-714**  
23 cm, 9"  
**F9-715**  
27 cm, 10 1/2"  
 straight

**F9-716**  
25 cm, 9"  
**F9-717**  
27 cm, 10 1/2"  
 curved

**Eohlin Cuckbill Bone Rongeur**  
23cm 9"

**F9-718**  
2 x 12mm  
 Double action  
 Curved on side

**F9-719**  
3 x 12mm  
 Double action  
 Curved on side

**F9-720**  
4.5 x 11mm  
 Double action  
 Curved on side



**Stille-Leur Rongeur**  
**F9-721** 21.5cm 8 1/2"  
 Curved, Straight  
 Double action, 10 x 18mm



**Stille-Leur Rongeur**  
**F9-722** 26.5cm 10 1/2"  
 Straight, Curved  
 Double action, 10 x 18mm



**Stille-Luer Echlin Duckbill Rongeur**  
 23cm 9"  
**F9-723** 6 x 13mm  
**F9-724** 6 x 15mm  
 Double action Curved on side

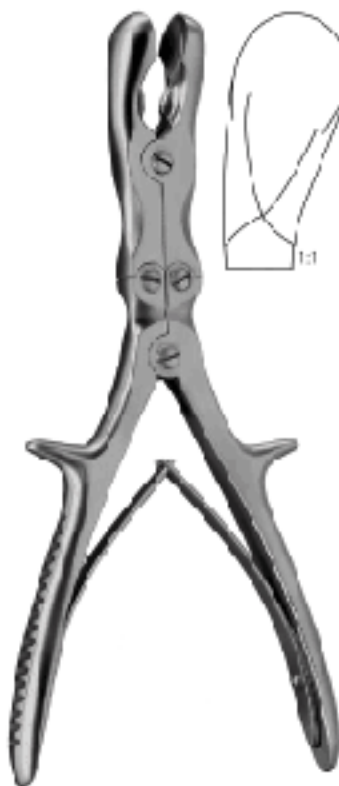

**Stille-Leur Rongeur**  
**F9-725** 21.5cm 8 1/2"  
 Double action  
 Curved 10 x 16mm

**Rettgen-Ruskin Bone Rongeur**  
**F9-726 23cm 9"**

**Samb Bone Rongeur**  
**F9-727 24cm 9 1/2"**

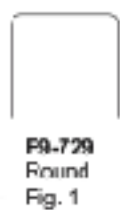
**Frykholm Bone Rongeur**  
**F9-728 24cm 9 1/2"**

**Sauerbruch Bone Rongeur**  
**30 cm, 12"**

**F9-729**  
**Round**  
**Fig. 1**

**F9-733**  
**Straight**  
**Fig. 2**

**Luer-Stille Bone Rongeur**  
**27 cm, 10 3/4"**

**F9-731**  
**Fig. 1**

**F9-732**  
**Fig. 2**

**F9-733**  
 24 cm, 9 1/2"

**F9-734**  
 24 cm, 9 1/2"

**F9-735** 23 cm, 8 3/4"  
 Duckbill  
 17 mm x 8 mm

**F9-736** 25cm 9 3/4" 3 x 16mm  
**F9-737** 23cm 9" 6 x 16mm  
**F9-738** 25cm 9 3/4" 4.5 x 16mm  
**F9-739** 25cm 9 3/4" 6 x 16mm  
**F9-740** 25cm 9 3/4" 7 x 16mm  
**F9-741** 25cm 9 3/4" 8 x 16mm  
 Double action, Curved 15"

**Leksell-Stille Bone Rongeur**
**Stille Bone Rongeur**
**Leksell Bone rongeur**

**Hakansson Bone Rongeur**  
**F9-742** 20cm, 8"

**F9-743** 15.25 cm, 6"  
 2 x 13 mm

**Kleinart-Kutz Bone Rongeur**

**F9-744** 15.25 cm, 6"  
 Curved 18 x 5 mm

**Ruskin-Mini Bone Rongeur**

**Syvert Rongeur**  
**F9-745** 35.5cm 14" 4 x 16mm  
**F9-746** 35.5cm 14" 8 x 16mm  
**F9-747** 35.5cm 14" 12 x 16mm  
**F9-748** 37cm 14 1/2" 5 x 16mm  
 Double action, Angled





**Cottle-Kazanjan Bone Cutting Rongeur Forceps**  
F9-749 19 cm, 7 1/2"



**Littauer / Liston Bone Cutting Rongeur Forceps**

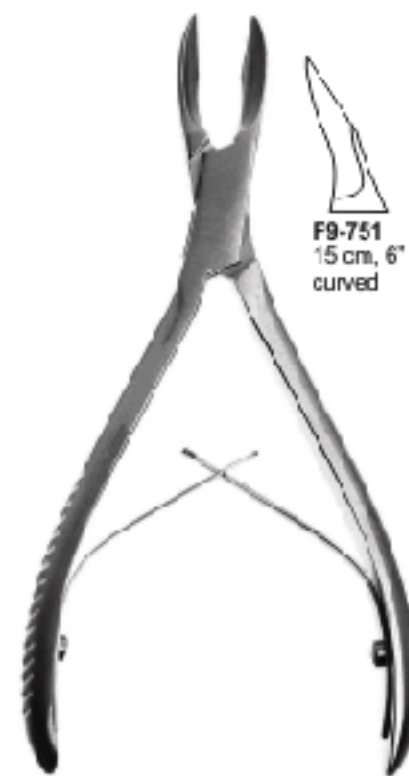

**Cleveland Bone Cutting Rongeur Forceps**



**F9-750**  
15 cm, 6"  
Straight



**F9-751**  
15 cm, 6"  
curved



**F9-752**  
17 cm 6 3/4"  
curved



**Liston Bone Cutting Rongeur Forceps**



**Liston Bone Cutting Rongeur Forceps**



**F9-753** 14 cm, 5 1/2"  
**F9-754** 17 cm, 6 3/4"  
**F9-755** 19 cm, 7 1/2"  
**F9-756** 20 cm 7 7/8"  
**F9-757** 22 cm, 8 5/8"  
Straight



**F9-758**  
14 cm, 5 1/2"  
Angled



**F9-759**  
17 cm, 5 3/4"  
Angled



**F9-760**  
18 cm, 7 1/2"  
Angled



**F9-761**  
22 cm, 8 3/4"  
Angled



**Stille-Liston Bone Cutting Rongeur Forceps**



**F9-762**  
27 cm, 10 3/4"  
Straight



**F9-763**  
27 cm, 10 3/4"  
Angled 45°



**F9-764**  
27 cm, 10 3/4"  
Angled 90°



**Semb Bone Cutting Rongeur Forceps**  
F9-765 24 cm, 9 1/2"



**Liston Key Hensley Bone Cutting Rongeur Forceps**  
F9-766 27 cm, 10 3/4"



**Hensley Bone Cutting Rongeur Forceps**  
F9-767 25 cm, 10"



**Ruskin Bone Cutting Rongeur Forceps**  
F9-768 20 cm, 8"  
Double-Action

**F9-769**  
 16 cm, 6 1/4"

**Cleveland-Gardner Bone Cutting Rongeur Forceps**

**F9-770**  
 20 cm, 8"

**Markwaller Bone Cutting Rongeur Forceps**

**Bone Cutting Rongeur Forceps**  
**F9-771** 15 cm, 5 7/8"

**F9-772**  
 15 cm, 6"  
 Straight

**Bohler Bone Cutting Rongeur Forceps**

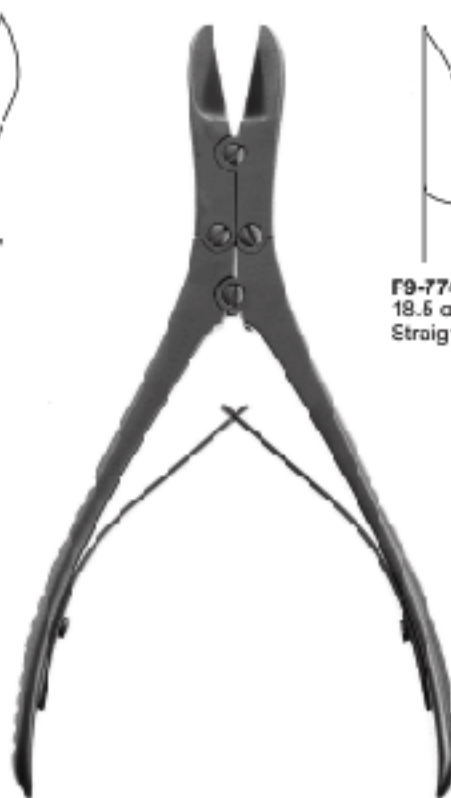
**F9-773**  
 15 cm, 6"  
 Angled

**F9-774**  
 18.5 cm, 7 1/4"  
 Straight

**Ruskin-Liston Bone Cutting Rongeur Forceps**

**F9-775**  
 18.5 cm, 7 1/4"  
 Angled

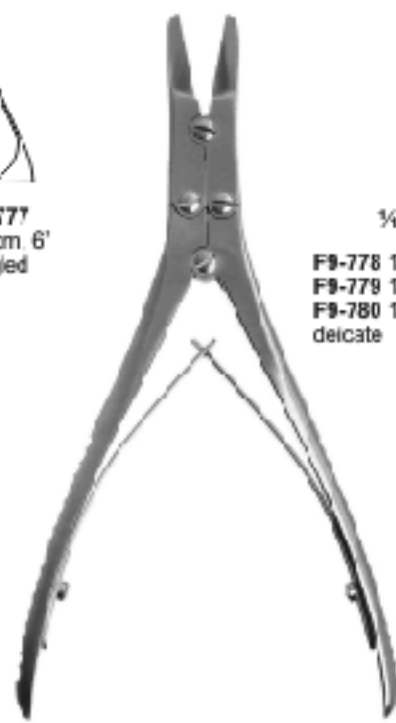
**F9-776**  
 15 cm, 6"  
 Straight

**F9-777**  
 15 cm, 6"  
 Angled

**F9-778** 19 cm 7 1/2" Straight  
**F9-779** 19 cm 7 1/2" Curved  
**F9-780** 19 cm 7 1/2" Angled delicate

**F9-781**  
 17.5 cm, 7"  
 Straight

**F9-782**  
 17.5 cm, 7"  
 Curved

**Walton-Liston Bone Cutting Rongeur Forceps**
**Ruskin Liston Bone Cutting Rongeur Forceps**
**Mc Indoe Bone Cutting Rongeur Forceps**

**Mc Indoe Bone Cutting Forceps**  
**F9-783** 18 cm 7"  
 Angled, delicate,

**Kleinert-Kutz Bone Cutting Forceps**  
**F9-784** 15 cm 5 3/8"  
 Straight, delicate,

**Kleinert-Kutz Synovectomy Rongeur**  
**F9-785** 15cm 5" 2 x 10mm  
 Double cutting,  
 Curved on side, delicate.



**F9-786**  
27 cm, 10 1/2"  
Straight

**Stille-Liston Bone Cutting Rongeur Forceps**



**Stille-Horsley Bone Cutting Forceps**  
F9-707 24 cm 9 3/8"



**F9-788**  
23 cm 9"  
Angled

**Liston Bone Cutting Rongeur Forceps**



**F9-780**  
27 cm, 10 1/2"  
Angled

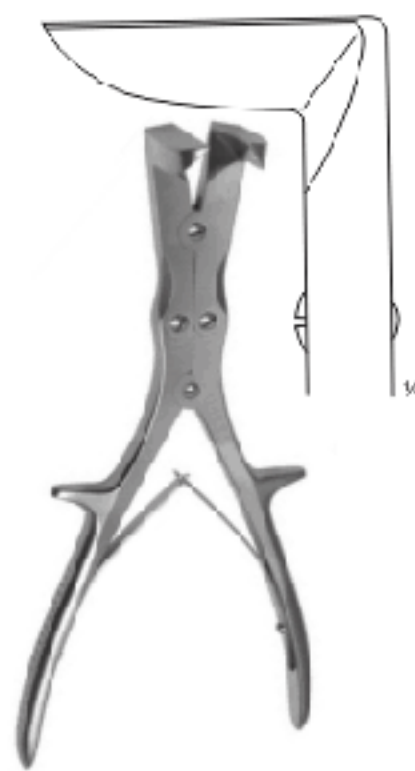

**Liston-Stille Bone Cutting Rongeur Forceps**  
F9-750 26 cm, 10 1/4"

*Drahtschneidezangen*  
Pincas coupantes

*Alicates para cortar alambre*  
Pinze taglia filo

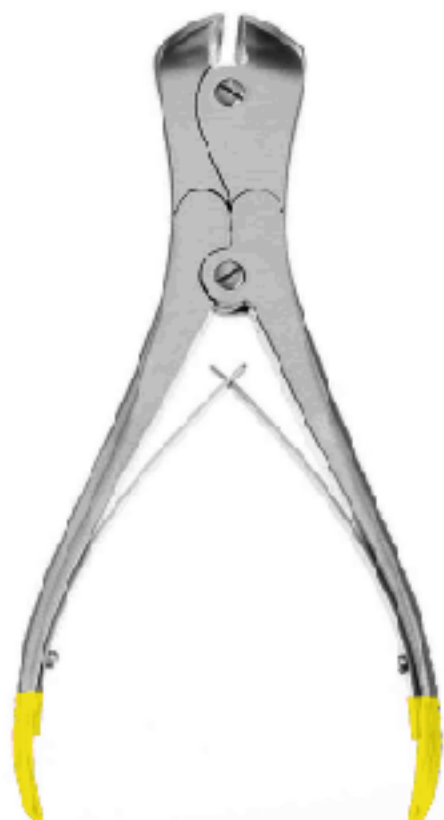

**Vital Wire Cutter**  
F9-791 22cm 8 3/4"  
for hard wires up to 2.2mm,  
for soft wires up to 3mm



**Vital Wire Cutter**  
F9-792 22cm 8 3/4"  
for hard wires up to 2.2mm,  
for soft wires up to 2.8mm



**Vital Wire Cutter**  
F9-793 23cm 9"  
for hard wires up to 2.2mm  
for soft wires up to 3mm



**Vital Wire Cutter**  
F9-794 18cm 7"  
for hard wires up to 1.5mm,  
for soft wires up to 2mm



**Vital Wire Cutter**  
F9-795 18cm 7"  
for hard wires up to 1.7mm,  
for soft wires up to 2mm



**Vital Wire Cutter**  
F9-796 15cm 6"  
for hard wires up to 1mm,  
for soft wires up to 1.5mm



**Vital Wire Cutter**  
F9-797 14.5cm 5 3/4"  
for hard wires up to 1mm,  
for soft wires up to 1mm



**Side Cutter**  
**F9-708** 18.5cm 7 1/4"  
 Welded carbide jaws  
 max capacity: 1.6mm 062"



**Delicate Wire Cutter**  
**F9-700** 12.5cm 4 7/8"  
 Side cutting w/ carbide inserts  
 max capacity: 0.7mm 028"



**Front & Side Wire Cutter**  
**F9-800** 17cm 6 3/4"  
 Front and side cutting w/ carbide inserts,  
 double action. Max capacity: 1.6mm 062"



**Double Action Wire Cutter**  
 Angled, Side cutting w/ carbide inserts  
**F9-301** 17cm 6 5/8"  
 max cap 1.3mm 062"  
**F9-302** 21.5cm 8 1/2"  
 max cap. 2.4mm 3/32"



**Flush Wire Cutter**  
**F9-803** 17cm 6 3/4"  
 Front and side cutting w/ carbide inserts,  
 double action. Max capacity: 1.5mm 050"



**Wire Forceps**  
**F9-804** 17 cm 6 1/2"  
 Straight serrated 5.4 mm tip

*Drahtschneidezanger*  
Pincas coupantes

*Alicates para cortar alambre*  
*Pincas taglia filo*



**Stille Plaster Shear**  
F9-805  
37cm 14 1/2" 5" to 15"



**Schumacher Sternum Shears**  
F9-806 21cm 8 1/4"



**Kirschner Wires & Steirmann Pins Cutter**  
F9-807 57cm 22 1/4"  
up to 6mm



**Cannulated Wire / Pin Cutter**  
F9-808 19 cm 7 1/2"  
Cuts wire upto 1.6 mm



**Hard Wire Cutter Cuts**  
F9-809 26.0cm 10 1/4"  
for hard wires up to 3mm



**Side Pin Cutter**  
F9-810 57.5cm 22 5/8"  
Side cutting w/ carbide inserts  
max. cap: 5/32"



*Drahtschneidezangen*
*Alicates para cortar alambre*
*Pinces coupantes*
*Pinze taglia filo*

**Pin Cutter Small**  
**F9-811** 26cm 10 1/4"  
 Max cap: 3.2mm



**Pin Cutter Medium**  
**F9-812** 36.5cm 14 3/8"  
 Max cap: 4.7mm



**Large Pin Cutter**  
**F9-813** 57.5cm 22 5/8"  
 Large, Straight. Max.  
 capacity 6.3mm 1/4"

*Knochenhalteklammern - Knochenhaltezangen | Pinzas porta huesos - Pinzas para huesos*  
*Daviers à os - Daviers porte-os* | *Tenaglie per ossa*



**Gerster-Lowman Bone Clamp**  
**F9-314** 17 cm, 4 7/8"  
**F9-315** 14.5cm 5 5/8"  
**F9-316** 18cm, 7", 23mm  
**F9-317** 20cm, 8", 35mm  
**F9-318** 22cm, 8 3/4", 40mm  
 1x2 Jaws

**Lambert-Lowman Bone Clamp**  
**F9-816** 17.5 cm, 7"  
**F9-820** 20.3 cm, 8"  
 2x2 Jaws

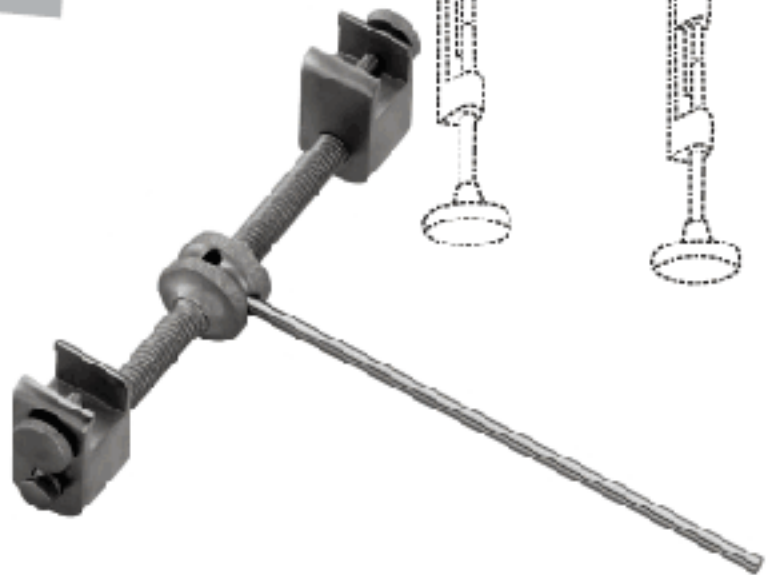

**Gerster Bone Holding Clamp**  
**F9-821** 15cm, 6"



**Gerster Bone Holding Clamp**  
**F9-822**

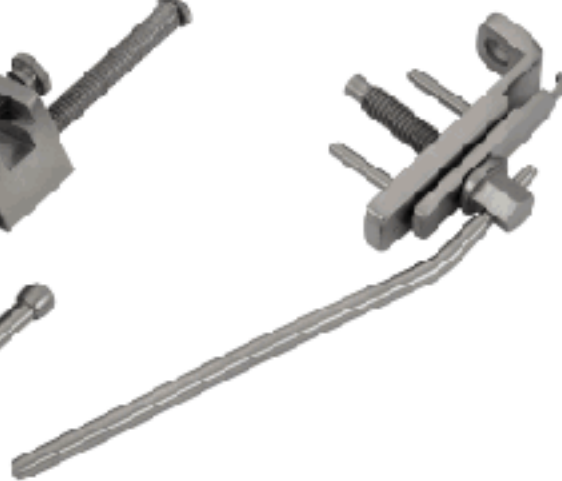

**Gerster Bone Holding Clamp**  
**F9-823**

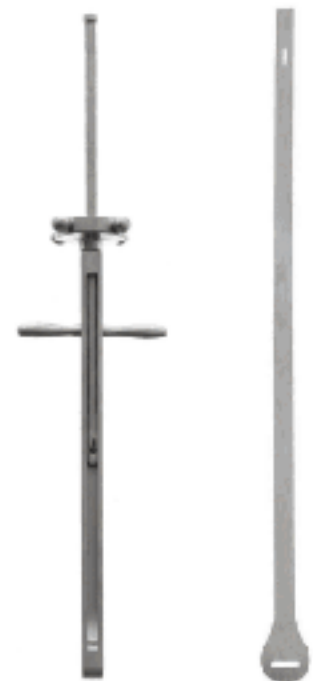

**Parham-Martin Bone Clamp**  
**F9-824** 21cm 8 1/4"  
 Straight  
**Parham Martin Bands**  
**F9-825** 19.0cm 7 1/2"

*Knochenhalte- zangen - Repositionszanger*  
*Daviers porte- os - pinces de reposition*

*Pinzas para huesos - pinzas para reposicion*  
*Tenaglie per ossa - Pinze per riposizioni*



**Done Reduction Forceps**  
**F9-026** 13.5cm, 5 1/4"



**Locke Phalangeal Forceps**  
**F9-027** 14cm, 5 1/2"



**Levin Perforating Bone Holding Forceps**  
**F9-828** 17.5cm, 7" corrated



**Staghaette Bone Reduction Forceps**  
**F9-829**  
 Pointed tips, 13cm 4.78"



**Bone Reduction Orthopedic Forceps**



**F9-830**  
 13.5 cm, 5 1/2"  
 Angled Serrated



**Shoulder Percussion Awl**  
 Pointed, 21.6cm 8 1/2"  
**F9-831** Small  
**F9-832** Medium  
**F9-833** Large  
**F9-834** Pointed, 23.5cm 9 1/4"

*Knochenhaltezaugen*  
*Deviers porte-os*

*Pinzas para huesos*  
*Tenaglia per ossa*



**Meniscus Clamp**  
**F9-835** 13.5cm 5 3/8"  
Serrated

**Meniscus Clamp**  
**F9-836** 13.5cm 5 3/8"  
Angled 20°, serrated

**Preston Ligamentum  
Flavum Forceps**  
**F9-837** 10cm 7 1/4"  
Curved, 1 x 2 teeth



**Meniscus Clamp**  
**F9-333** 18cm 7 1/8"  
Straight, Curved shaft

**Dingman Bone Clamp**  
**F9-339** 19cm 7 1/2"  
Straight, Serrated,  
1 1/2" tip length  
Curved shaft

*Knochenhalte-  
zangen*  
*Devisers porte-os*
*Pinzas para huesos*  
*Tenaglie per ossa*



**Ferguson Bone Holding  
Forceps**  
F9-840 21.0 cm, 8 1/4"  
2 x 2 teeth



**Van Buren Sequestrum  
Forceps**  
F8-841 23.0 cm, 9"  
Curved on side, serrated

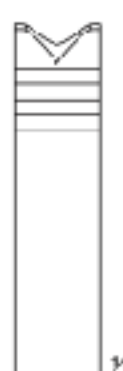

**Langenbeck Bone Holding  
Forceps**  
F9-842 21 cm, 8 1/4"



**Semb Bone Holding Forceps**  
F9-843 19 cm, 7 1/2" without ratchet  
curved sideways deep teeth



**Semb Bone Holding Forceps**  
F9-844 20.3 cm, 8", with ratchet  
curved sideways deep teeth



**Sequestrum (Nirrosis)  
Bone Holding Forceps**



**F9-845**  
17.8 cm, 7"  
**F9-846**  
20 cm, 8"  
**F9-847**  
22.9 cm, 9"  
straight

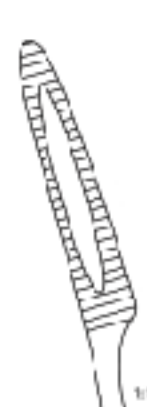

**F8-848**  
17.8 cm, 7"  
**F8-849**  
20 cm, 8"  
**F8-850**  
22.9 cm, 9"  
angled or flat

*Knochenhalte-zangen*  
*Deviers porte-os*
*Pinzas para huesos*  
*Tenaglie per ossa*

**Farabeuf Bone Holding Forceps**  
**F0-861** 23 cm, 9"  
**F0-862** 26 cm, 10 1/4"  
 with adjustable jaw

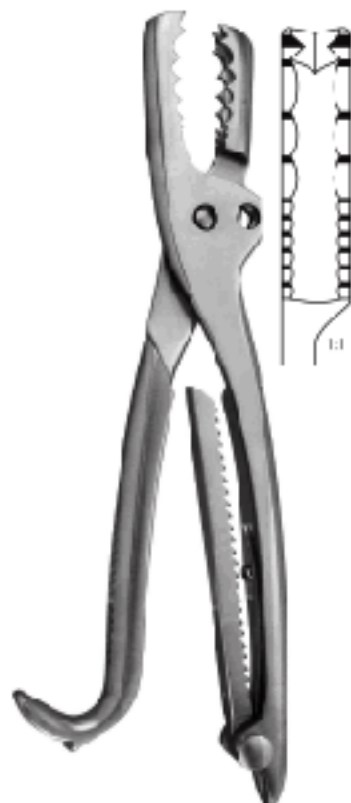

**Farabeuf-Lambotte Bone Holding Forceps**  
**F0-863** 25 cm, 10 1/4"  
 with adjustable jaw

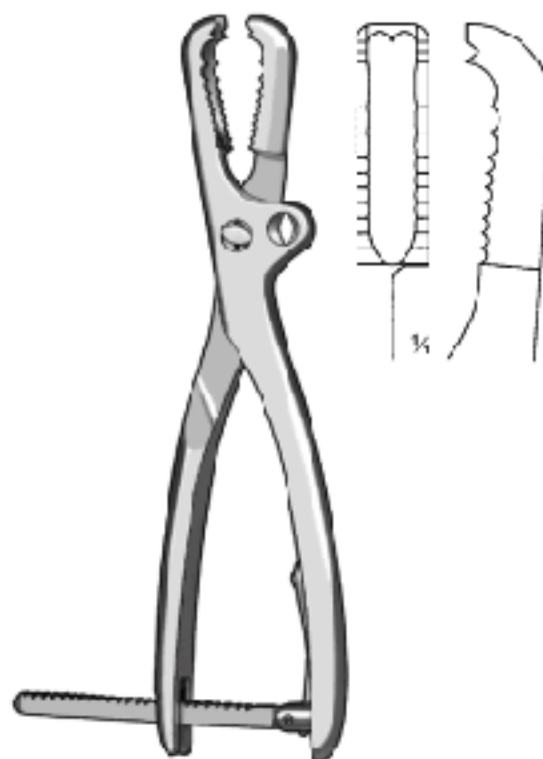

**Farabeuf-Lambotte Bone Holding Forceps**  
**F0-864** 26 cm, 10 1/4"  
 with adjustable jaw



**Bishop Bone Clamp**  
**F0-353** 22.5 cm, 8 7/8"  
 Straight



**Kern Bone Holding Forceps**  
**F0-856** 17 cm, 6 3/4"  
**F0-857** 24 cm, 9 1/2"  
 without ratchet



**Kern Bone Holding Forceps**  
**F0-355** 17 cm, 6 3/4"  
**F0-359** 24 cm, 9 1/2"  
 with ratchet

*Knochenhalte-zangen*  
*Devisers porte-os*
*Pinzas para huesos*  
*Tenaglie per ossa*

**Hey Groves Bone Holding Forceps**

- F9-860** 21 cm, 8 1/4"
- F9-861** 27 cm, 10 3/4"
- F9-862** 30 cm, 12"

**Lane Bone Holding Forceps Light Model**

- F9-863** 33 cm 13" 11 mm tip w/ Ratchet
- F9-864** 33 cm 13" 13 mm tip w/ Ratchet
- F9-865** 43 cm 17" 13.5 mm tip w/ Ratchet
- F9-866** 13 cm 13" 10 mm tip w/ Ratchet

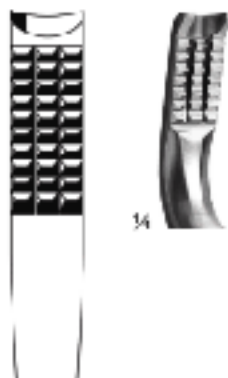

34

**Lane Bone Holding Forceps**

- F9-867** 33 cm 13" 13 mm tip
- F9-868** 43 cm 14" 12 mm tip without ratchet

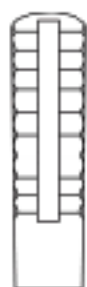
**Ulrich Bone Holding Self Retaining Forceps**

- F9-869** 18 cm, 7" mini
  - F9-870** 22 cm, 8 1/2"
  - F9-871** 26 cm, 10"
  - F9-872** 28 cm, 11"
- Straight, with speed lock

**Ulrich Bone Holding Forceps**

- F9-873** 18 cm, 7"
  - F9-874** 22 cm, 8 1/2"
  - F9-875** 26 cm, 10"
  - F9-876** 28 cm, 11"
- Angular, with speed lock



**Ulrich Bone Holding Forceps**  
**F9-877** 28 cm 11"  
 Angular With Speed Lock & swivel jaw



**Lambotte Bone Holding Forceps**  
**F9-878** 22 cm, 8 3/4"  
**F9-879** 27 cm, 10 3/4"  
**F9-880** 30 cm, 12"  
 One Jaw Nobile  
 adjustable jaw

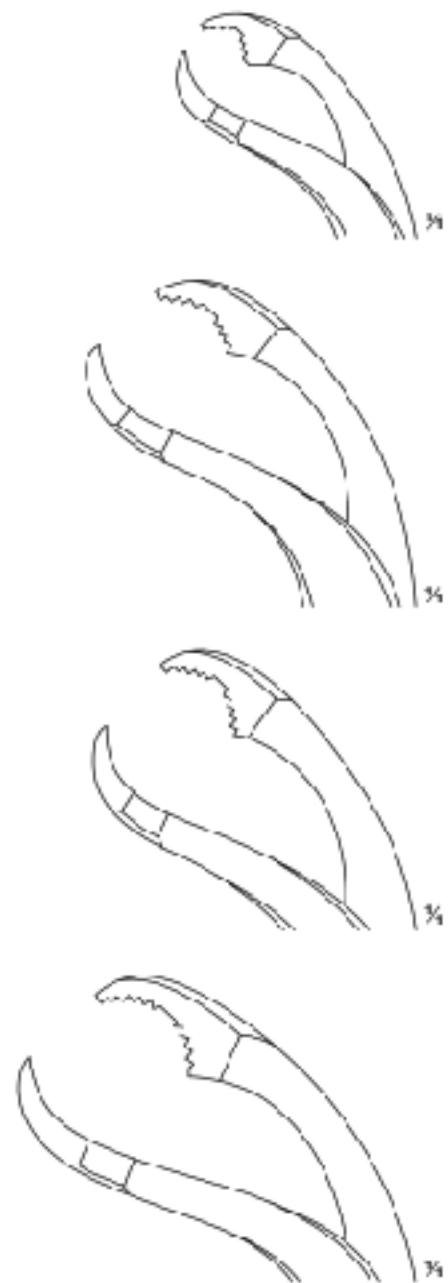

**Lambotte Bone Holding Forceps**  
**F9-881** 15 cm, 6", 2.5mm  
**F9-882** 19 cm, 7 1/2", 6.5mm  
**F9-883** 24 cm, 9 1/2", 9.5mm  
**F9-884** 26 cm, 10 1/4", 10mm  
**F9-885** 28 cm, 11", 11"  
 Self-Centering, with speed lock





*Knochenhalte-zangen*  
*Devisers porte-os*
*Pinzas para huesos*  
*Tenaglie per ossa*

**Subacromion Spreader**  
**F9-005** 26.75cm 10.5" Right  
**F9-007** 26.75cm 10.5" Left



**Bone Reduction Forceps**  
**F9-000** 14 cm 5 1/2" Curved  
**F9-009** 15 cm 6" Serrated



**Bone Reduction Forceps,  
 Pointed Tips**  
**F9-050** 14 cm 5 1/2" Serrated  
**F9-051** 14 cm 5 1/4" Curved  
**F9-052** 17 cm 6 3/4" Curved



**Lane Bone Holding  
 Forceps**  
**F9-893** 31.5 cm  
**F9-894** 39 cm



**Bone Reduction Forceps**  
**F9-895** 14 cm 5 1/4"  
 Serrated with pointed tips



**Semb Bone Holding Forceps**  
 Curved on side  
**F9-896** 19 cm 7 1/2" 4 x 5 teeth  
**F9-897** 21 cm 8 1/5" 5 x 5 teeth

*Knochenhalte-zangen*  
*Devisers porte-os*

*Pinzas para huesos*  
*Tenaglie per ossa*



**Martin Cartilage Bone Holding Clamp Forceps**  
F9-898 19 cm, 7 1/2" Sz.

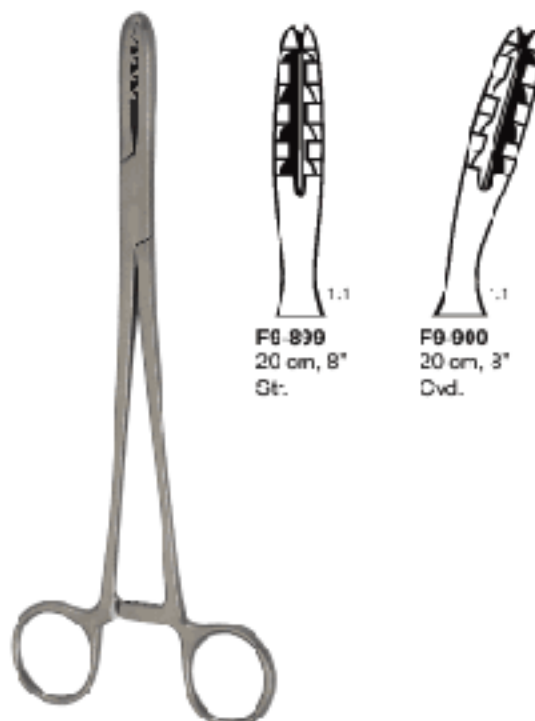

**F9-899**  
20 cm, 8"  
Gt.

**F9-900**  
20 cm, 8"  
Ovd.

**Dircher-Ganske Bone Holding Forceps**



**Verbrugge Bone Holding Forceps**



**F9-901**  
17.5 cm, 7"  
5.0mm



**F9-902**  
25 cm, 10"  
8.5mm

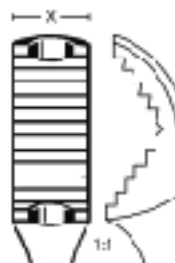

**F9-903**  
29 cm, 10 1/4"  
12.5mm

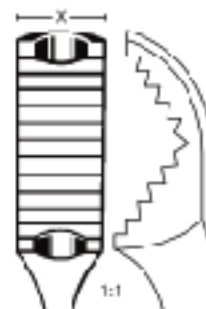

**F9-904**  
27 cm, 10 3/4"  
12.0mm

**Verbrugge Bone Holding Forceps**

- F9-905** 18 cm 7"
- F9-906** 26 cm 10"
- F9-907** 27 cm 10 1/2"
- F9-908** 28 cm 11"
- W/ Long Ratchet

**Verbrugge Self-Centering Bone Holding Forceps**

- F9-909** 15 cm 5 3/4"
- F9-910** 19 cm 7 1/4"
- F9-911** 24 cm 9 1/4"
- F9-912** 26 cm 10"
- F9-913** 29 cm 11 1/4"
- with long ratchet

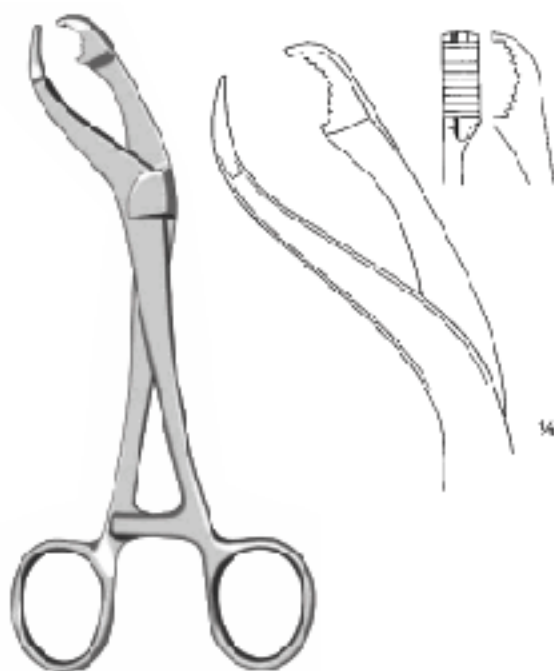
**Verbrugge Bone Holding Forceps**

- F9-914** 17.2cm, 6.75"
- with short ratchet

**Lane Bone Plate Holding Forceps**

- F9-915** 22cm 8 3/4"



**Verbrugge Bone Holding Forceps**  
**F9-916** 18 cm, 7"



**Verbrugge Bone Holding Forceps**  
**F9-917** 18 cm, 7"



**Verbrugge Bone Holding Forceps**  
**F9-918** 25 cm, 10"  
**F9-919** 26 cm, 10 1/4"  
**F9-920** 27 cm, 10 1/2"



**Verbrugge Bone Holding Forceps**  
**F9-921** 25 cm, 10"  
**F9-922** 26 cm, 10 1/4"  
**F9-923** 27 cm, 10 1/2"



**Verbrugge Bone Holding Forceps**  
**F9-924** 18 cm, 7"



**Verbrugge Bone Holding Forceps**  
**F9-925** 25 cm, 10"  
**F9-926** 26 cm, 10 1/4"  
**F9-927** 27 cm, 10 1/2"

*Knochenhalte-zangen*  
*Docters porte-os*

*Pinzas para huesos*  
*Tenaglie per ossa*



**Bone Reduction Forceps**  
F9-928 13.5 cm, 5 1/4"



**Reill Bone Reduction Forceps**  
F9-929 17 cm 6 3/4"  
Curved, pointed tips



**Bone Reduction Forceps**  
F9-930 20.4 cm, 8"  
Pointed tips



**Bone Reduction Forceps**  
F9-931 13.5 cm, 5"  
for maxillary reposition



**Haase**  
F9-932  
16.5 cm, 6 1/2"  
for mandibular  
fracture



**F9-933**  
9.5 cm, 3 3/4"

**F9-934**  
9.5 cm, 3 3/4"

**Bone Holding forceps**

*Knochenhaltezaugen*  
*Deviers porte-os*

*Pinzas para huesos*  
*Tenaglie per ossa*



**Fibula Bone Holding Forceps**  
F9-935  
22 cm 8 1/2"



**Glenoid Perforating Forceps**  
F9-936 17 cm 6 1/2"  
Lightly curved, pointed tips  
Strongly curved, pointed tips



**Reil Bone Holding Forceps**  
F9-937 17 cm, 7"



**Bone Reduction Forceps**  
F6-938 20 cm, 3"  
with Points



**Malleolar Bone Holding Forceps**  
F9-939 21 cm 8 1/4"  
Straight, 1 x 1 teeth

*Knochenhalte-  
zangen*  
*Deviers porte-os*
*Pinzas para huesos*  
*Tenaglie per ossa*

**Patella Malleolar Forceps**  
**F9-940** 21.0 cm, 8 1/4"

**Reduction Forceps**  
**F9-941** 16 cm, 6 1/2"  
**F9-942** 24 cm, 9 1/2"  
 with Thread Lock

**Reposition Forceps**  
**F9-943** 23 cm, 9"

**Pelvic Reposition Forceps**  
**F9-944** 19 cm, 7 1/2"

**Pelvic Reposition Forceps**  
**F9-945** 23 cm, 9"

**Pelvic Reposition Forceps**  
**F9-946** 25.0 cm, 10"

*Knochenhalte-zangen*  
*Devisers porte-so*

*Pinzas para huesos*  
*Tenaglie per ossa*



**Pelvic Reposition Forceps**  
**F9-947** 25 cm, 10"  
3 Balls Spikes



**Pelvic Reposition Forceps**  
**F9-948** 40 cm, 15 3/4"



**Pelvic Reposition Forceps**  
**F9-949** 40 cm, 15 3/4"



**Pelvic Reduction Forceps Asymmetric**  
**F9-950** 25 cm, 10"  
with 3 ball Spikes



**Pelvic Reduction Forceps Asymmetric**  
**F9-951** 25 cm, 10"



**Pelvic Reduction Forceps Asymmetric**  
**F9-952** 40 cm, 15 3/4"





**Moore Drill And Bit Set Complete**  
**F9-953**



**Stille Pattern Drill Set**  
**F9-954**  
 Complete set of stainless  
 drill bits and burs



**Fig. 1**  
**F9-955**  
 2.5mm



**Fig. 2**  
**F9-956**  
 3.0mm



**Fig. 3**  
**F9-957**  
 3.5mm



**Fig. 4**  
**F9-953**  
 4.0mm



**Fig. 5**  
**F9-959**  
 5.0mm



**Fig. 6**  
**F9-960**  
 8.0mm



**Fig. 7**  
**F9-961**  
 12.0mm



**Fig. 8**  
**F9-962**  
 16.0mm



**Fig. 09**  
**F9-963**



**Fig. 10**  
**F9-964**  
 1.0mm



**Fig. 11**  
**F9-965**  
 1.5mm



**Fig. 12**  
**F9-963**  
 2.0mm



**F9-967**  
Hudson Brace 10 1/2" (26.7cm),  
with standard thumb screw chuck

**F9-968**  
Hudson Brace 11" (27.9cm),  
with Improved Snap-Lock chuck

- C F9-969 Hudson Bur, 9mm Diameter
- D F9-970 Hudson Bur, 14mm Diameter
- E F9-971 Hudson Bur, 16mm Diameter
- F F9-972 Hudson Bur, 22mm Diameter
- G F9-973 Cushing Perforator, for Hudson Brace
- H F9-974 Hudson Cerebellar Extension, 4" for Hudson Brace
- I F9-975 McKenzie Perforator for Hudson Brace



**Jacobs**  
**F9-976** 28cm 11"  
 opening up to 6.35mm



**Hand Drill**  
**F9-977**  
 opening up to 6.35mm



**T-Handle**  
**F9-978**  
 AD Coupling



**Jacob's Chuck**  
**F9-979** T-Handle and key  
**F9-980** only  
**F9-981** Key



**Key Handle**  
**F9-982**



**T-Handle**  
**F9-983**  
 for AD Coupling



**Memoral Head Extractor**  
**F9-984**

**HEXAGONAL HEAD**

	Size of screws	Head Size	Fiber-handle	AO Coupling	Dental Coupling
A	1.5mm	1.5mm	<b>F9-985</b>	<b>F9-988</b>	<b>F9-991</b>
B	2.0mm				
C	2.7mm				
D	3.5mm	2.5mm	<b>F9-986</b>	<b>F9-989</b>	
E	4.0mm				
F	4.5mm	3.5mm	<b>F9-987</b>	<b>F9-990</b>	
G	6.5mm				



## TWIST DRILLS - REAMERS - FORCEPS

Spiralbohrer - Pfieme - zangen  
Meches - Alenes - Daviers

Taladros espirales - Escariadores - Pinzas  
Punte a spirale - Perforatori a mano - Tenaglie



Parallel Target Device  
F9-992  
for guide wires 2mm



Mortising Chisel  
F9-993



Wire Guide  
F9-994  
45mm



Wire Guide  
F9-995  
70mm



Countersink  
F9-996



Countersink  
F9-997



Countersink  
F9-998



Pertles  
F9-999 18cm 7"  
F9-1000 21cm 8 1/4"



F9-1001  
14cm 5 1/2"



F9-1002  
14cm 5 1/2"



**Mini Drill Sleeve**  
**F9-1003**  
 1.1 mm and 1.5 mm drill bits  
**F9-1004**  
 1.5 mm and 2.0 mm drill bits



**Drill Guide**  
**F9-1005**  
 drill sleeve for 2.0 mm  
 drill bit



**F9-1006** Tap Sleeve, 2.0 mm  $\phi$   
**F9-1007** Drill Sleeve, 2.7 mm  $\phi$   
**F9-1008** Tap Sleeve, 2.5 mm  $\phi$   
**F9-1009** Drill Sleeve, 3.5 mm  $\phi$



**Neutral & Load Drill Guide**  
**F9-1010** 1.5 mm for 2.0 mm Screws  
**F9-1011** 2.0 mm for 2.7 mm Screws  
**F9-1012** 2.5 mm for 3.5 mm Screws  
**F9-1013** 3.2 mm for 4.5 mm Screws



**Tap Sleeve**  
**F9-1014**  
 3.5 mm



**Tap Sleeve**  
**F9-1015**  
 3.5 mm also for used  
 as 3.2 mm drill Guide



**Tap Sleeve**  
**F9-1016**  
 4.5 mm



**Drill Sleeve**  
**F9-1017**  
 3.2 mm for Round  
 Hole Plates

**Insert Drill Sleeve**

**F9-1018** 2.7 / 2.0 mm Drill Bit 2.0 mm  
**F9-1019** 3.5 / 2.5 mm Drill Bit 2.5 mm  
**F9-1020** 4.5 / 3.2 mm Drill Bit 3.2 mm

**Drill Small Pointed**

**F9-1021**  
 Drill Bit 3.5 mm

**Drill Pointed Guide**

**F9-1022**  
 6.5 mm

**Drill Pointed Guide**

**F9-1023**  
 6.5 mm

**Drill Guide**  
**F9-1024**

4.5 mm Screws  
 Drill Bit 4.5 mm &  
 3.2 mm

**Drill Guide**  
**F9-1025**

6.5 mm Screws  
 Drill Bit 3.2 mm

**Drill Guide**  
**F9-1026**

3.5 mm for neutral  
 and compression Positioning  
 Drill Bit 2.5 mm

**C - Clamp**  
**F9-1027**

Drill Guide with thread  
 for Drill Bit 4.5 mm



**Bending Device  
F9-1028**  
21.5cm 8 1/4"  
to bend straight  
and angled plates



**Rod Bender  
F9-1029**  
to bend straight  
and angled



**Universal Rod Bender  
F9-1030**  
28.5cm 11 1/4"  
to bend straight  
and angled



**Rod Bender  
F9-1031**  
to bend straight  
and angled



**Slotted Hammer  
F9-1032 14mm**





Plate Bender  
F9-1033



Plate Bender  
F9-1034



Plate Bender  
F9-1035



Plate Bender  
F9-1036



Plate Bender  
F9-1037



Plate Bender  
F9-1038



Plate Bender  
F9-1039



**F9-1040** 18cm, 7"  
 Wire strainer for  
 kirschner wires



**Kirschner Extension Bows**  
**F9-1041** x=95mm y=70mm  
**F9-1042** x=100mm y=100mm  
**F9-1043** x=120mm y=120mm  
**F9-1044** x=155mm y=155mm  
**F9-1045** x=200mm y=155mm  
 with 3 traction hooks



**Kirschner Extension Bows**  
**F9-1046** x=130mm  
**F9-1047** x=185mm  
**F9-1048** x=220mm  
 with 3 traction hooks



**Wrench**  
**Kirschner**  
**Extension Bows**  
**F9-1049**  
 14mm/17mm

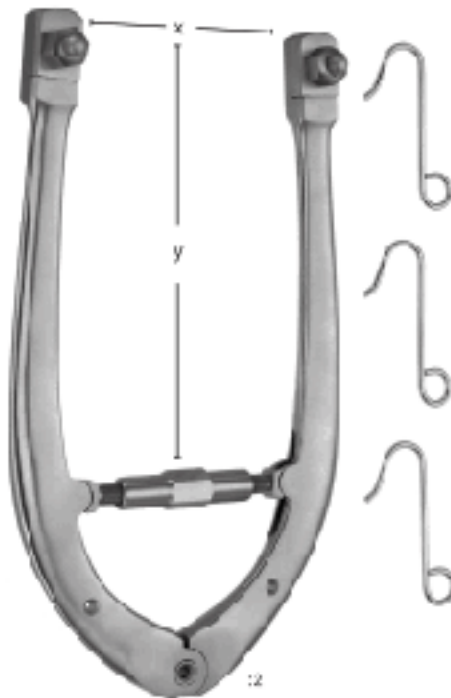

**Kirschner Extension Bows**  
**F9-1050** x=180mm y=100mm  
**F9-1051** x=270mm y=160mm  
 with 3 traction hooks

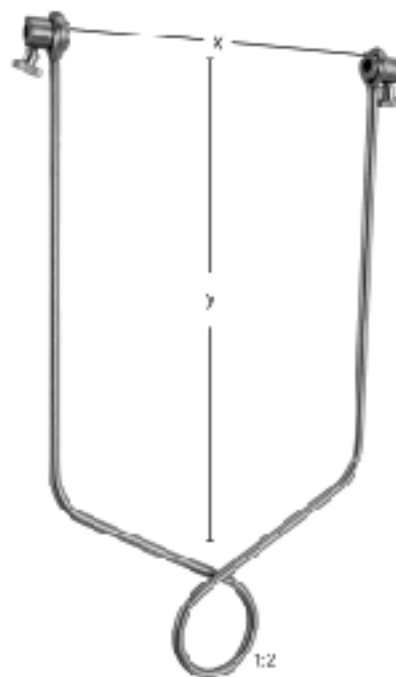

**Bohler Kirschner Extension Bows**  
**F9-1052** x=75mm y=90mm  
**F9-1053** x=90mm y=160mm  
**F9-1054** x=110mm y=210mm  
**F9-1055** x=150mm y=210mm  
 with 3 traction hooks



**Charnley-mueller**  
**F9-1056**  
 Compression Clamp

**Screw Depth Gauges**

- F9-1057 Mini Gauge, 4 3/4" Long measures up to 30mm
- F9-1058 Small Gauge, 6 1/2" Long measures up to 50mm
- F9-1059 Large Gauge, 8 3/4" Long measures up to 100mm
- F9-1060 X Large Gauge, 11" Long measures up to 120mm

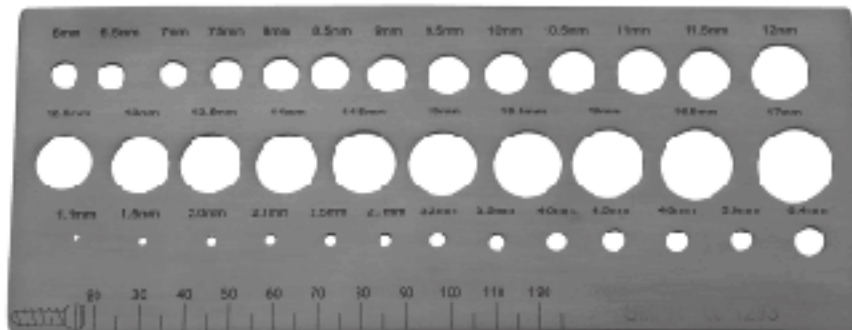
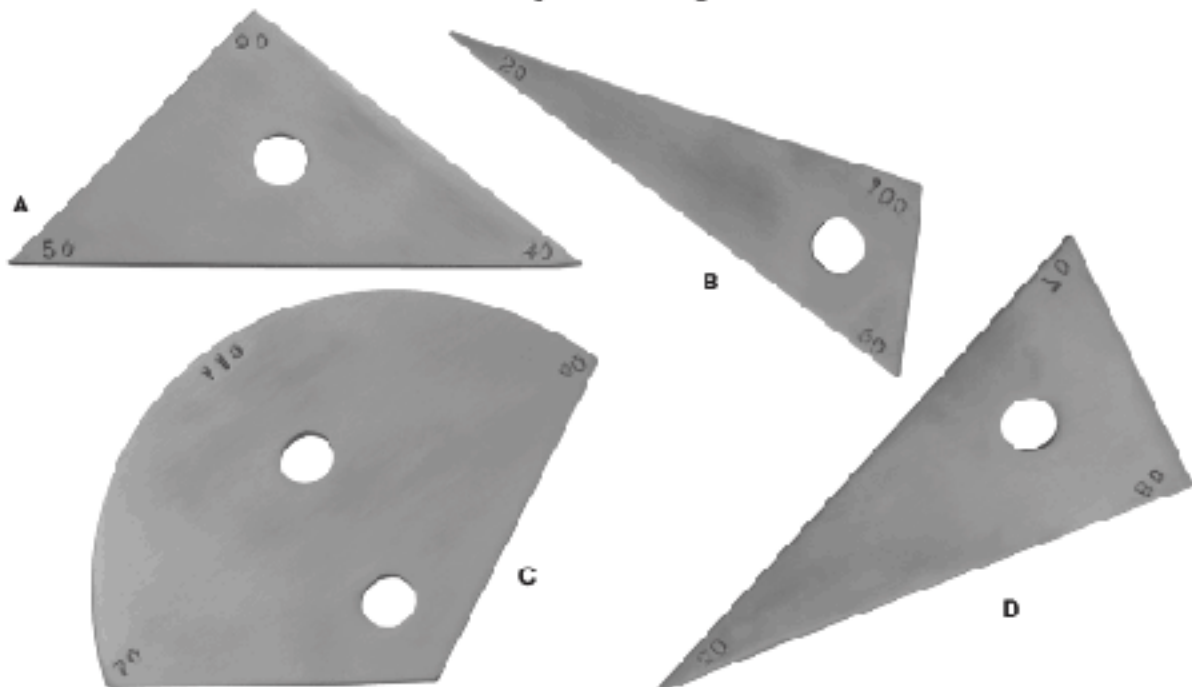

**Screw Depth Gauges**

- F9-1061 Mini Gauge, 4 3/4" Long measures up to 30mm
- F9-1062 Small Gauge, 6 1/2" Long measures up to 50mm
- F9-1063 Large Gauge, 8 3/4" Long measures up to 100mm
- F9-1064 X-Large Gauge, 11" Long measures up to 120mm

**Measuring Gauge  
F9-1065  
for rail**
**F9-1066 Tri Angular Positioning Plate**

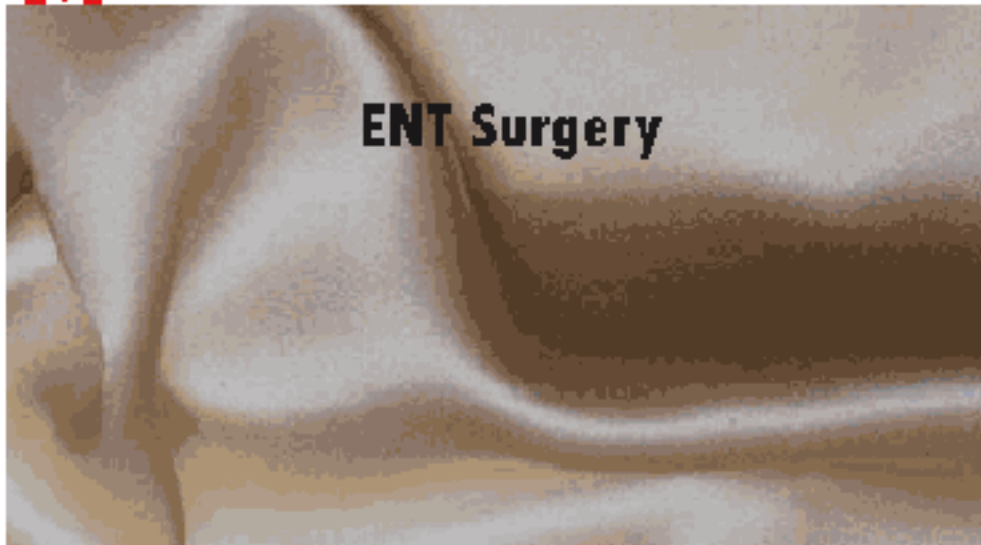

# ENT Surgery



**F10-001**  
4.5 mm Ø

**F10-002**  
5.5 mm Ø

**F10-003**  
6.5 mm Ø

**F10-004**  
7.5 mm Ø

**F10-007**  
2 mm Ø

**F10-008**  
3 mm Ø

**F10-009**  
4 mm Ø

**F10-010**  
5 mm Ø

**Toybee Ear Speculum**  
3.6 cm 1 1/4"  
Set for adults

**F10-005**  
Set of 3  
5.5 mm  
6.5 mm  
7.5 mm

**F10-006**  
Set of 4  
4.5 mm  
5.5 mm  
6.5 mm  
7.5 mm

**Politzer Ear Speculum**  
Set for adults

**F10-011**  
Set of 3  
2 mm  
3 mm  
4 mm

**F10-012**  
Set of 4  
2 mm  
3 mm  
4 mm  
5 mm

**Gruber Ear Speculum**  
Set for adults

**F10-013**  
a - 4.5 mm Ø

**F10-014**  
a - 5.5 mm Ø

**F10-015**  
a - 6.5 mm Ø

**F10-016**  
a - 7.5 mm Ø

**Gruber Ear Speculum**  
Set for adults

**F10-017**  
a - 4.5 mm Ø

**F10-018**  
a - 5.5 mm Ø

**F10-019**  
a - 6.5 mm Ø

**F10-020**  
a - 7.5 mm Ø

**F10-021**  
4.5 mm Ø

**F10-022**  
5.5 mm Ø

**F10-023**  
6.5 mm Ø

**F10-024**  
7.5 mm Ø

**F10-025**  
3 mm Ø

**F10-026**  
4.5 mm Ø

**F10-027**  
5.5 mm Ø

**Boucheron Ear Speculum**  
Set for adults

**Boucheron Ear Speculum**  
Set for children



Hartmann  
Tuning Fork  
F10-028  
C 64



Hartmann  
Tuning Fork  
F10-029  
c 128



Hartmann  
Tuning Fork  
F10-030  
c1 256



Hartmann tuning  
fork with or without  
plastic base s1 440  
F10-031  
s1 440



Tuning Forks neurol  
with hammer  
F10-032



Barany Noise Drum  
F10-033

**NOISE DRUM**

*Lärmtrommel* | *Aparato*  
*Assourdisseur* | *Assordatore*



Lucae  
Tuning Fork  
F10-034  
c 128  
Variable up to h (ahn, h)



Rydal-Seiffert  
Tuning Fork  
F10-035  
C 64 i.e. 128  
With damps C 64,  
Without damps c 128



French  
Tuning Fork  
F10-036  
C2 16



French  
Tuning Fork  
F10-037  
C1 32



## TUNING FORKS

<i>Stimmgabeln</i>	<i>Diapasones</i>
<i>Diapasons</i>	<i>Diapasoni</i>

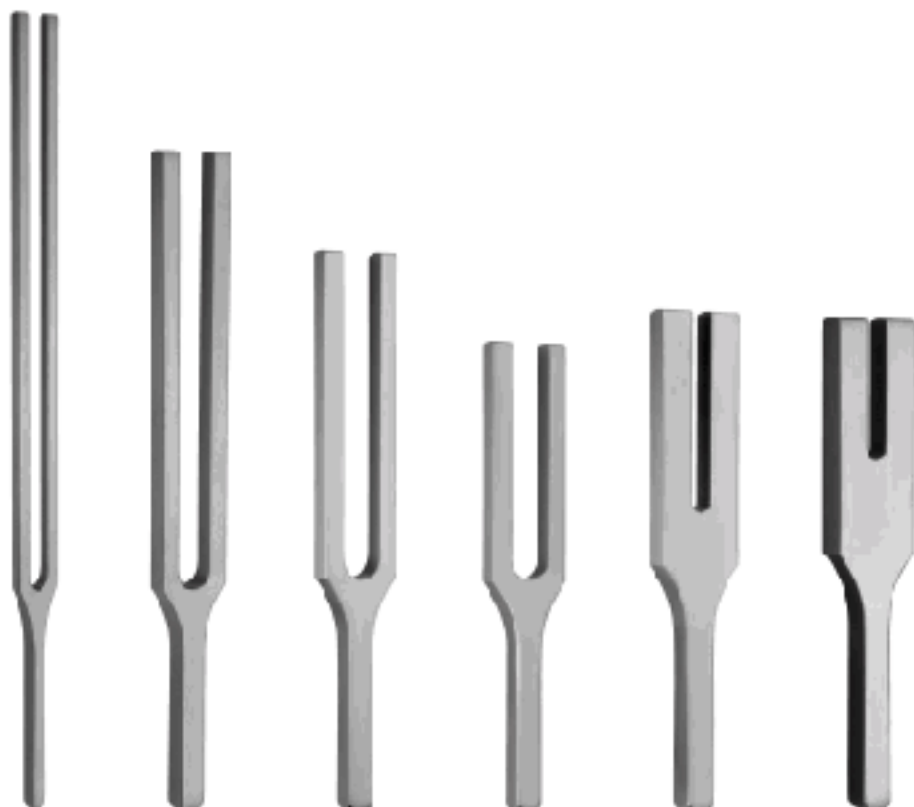

F10-038  
c 128

F10-039  
a1 266

F10-040  
a2 512

F10-041  
a3 1024

F10-042  
a4 2048

F10-043  
c5 4096

Hartmann Tuning Fork



F10-044  
Hartmann tuning Forks Set case/5



F10-046  
a 128

F10-046  
a1 266

F10-047  
c2 512

F10-048  
a3 1024

F10-048  
a4 2048



F10-050  
TUNING FORKS Set in case of 5



# EAR CURETTES

<i>Ohrküretten</i>	<i>Curetas auriculares</i>
<i>Curette auriculaires</i>	<i>Curette auricolari</i>

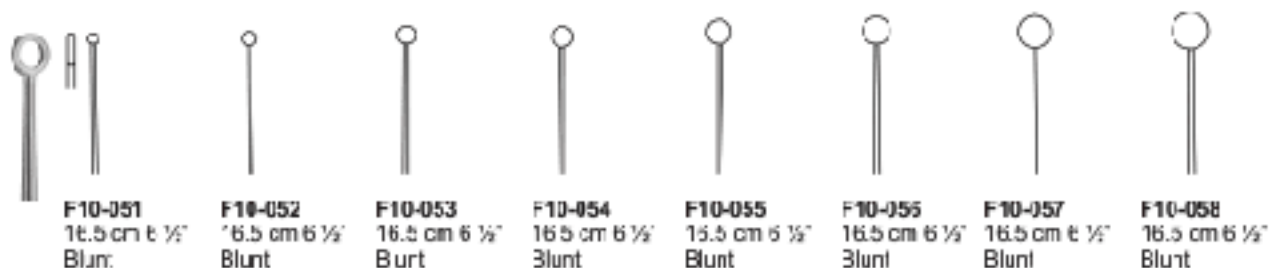

**F10-051**  
16.5 cm 6 1/2"  
Blunt

**F10-052**  
16.5 cm 6 1/2"  
Blunt

**F10-053**  
16.5 cm 6 1/2"  
Burt

**F10-054**  
16.5 cm 6 1/2"  
Blunt

**F10-055**  
15.5 cm 6 1/2"  
Blunt

**F10-056**  
16.5 cm 6 1/2"  
Blunt

**F10-057**  
16.5 cm 6 1/2"  
Blunt

**F10-058**  
16.5 cm 6 1/2"  
Blunt

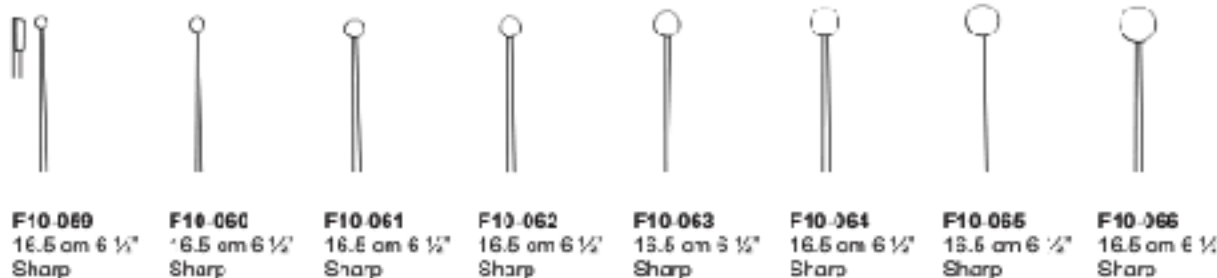

**F10-060**  
16.5 cm 6 1/2"  
Sharp

**F10-061**  
16.5 cm 6 1/2"  
Sharp

**F10-062**  
16.5 cm 6 1/2"  
Sharp

**F10-063**  
15.5 cm 6 1/2"  
Sharp

**F10-064**  
16.5 cm 6 1/2"  
Sharp

**F10-065**  
16.5 cm 6 1/2"  
Sharp

**F10-066**  
16.5 cm 6 1/2"  
Sharp

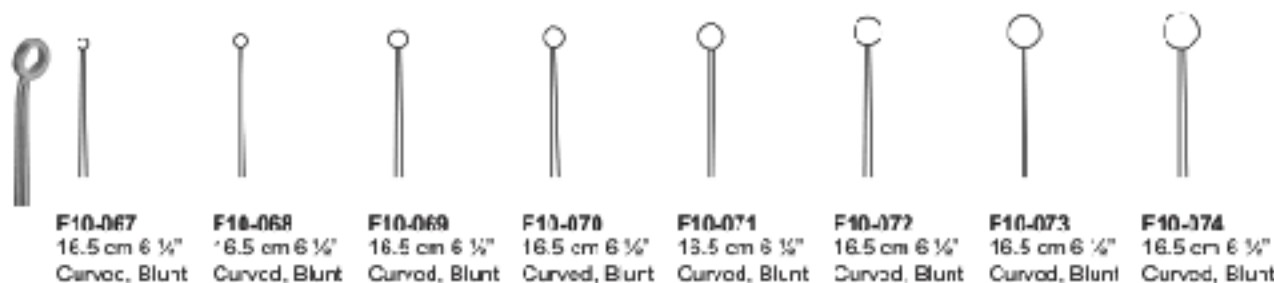

**F10-067**  
16.5 cm 6 1/2"  
Curved, Blunt

**F10-068**  
16.5 cm 6 1/2"  
Curved, Blunt

**F10-069**  
16.5 cm 6 1/2"  
Curved, Blunt

**F10-070**  
16.5 cm 6 1/2"  
Curved, Blunt

**F10-071**  
15.5 cm 6 1/2"  
Curved, Blunt

**F10-072**  
16.5 cm 6 1/2"  
Curved, Blunt

**F10-073**  
16.5 cm 6 1/2"  
Curved, Blunt

**F10-074**  
16.5 cm 6 1/2"  
Curved, Blunt

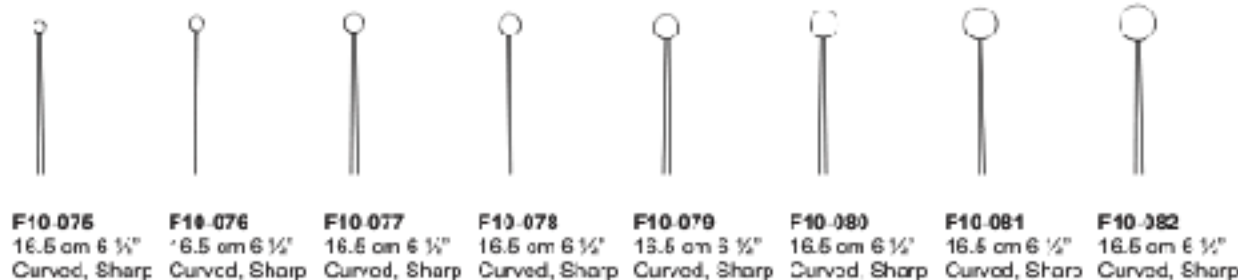

**F10-075**  
16.5 cm 6 1/2"  
Curved, Sharp

**F10-076**  
16.5 cm 6 1/2"  
Curved, Sharp

**F10-077**  
16.5 cm 6 1/2"  
Curved, Sharp

**F10-078**  
16.5 cm 6 1/2"  
Curved, Sharp

**F10-079**  
15.5 cm 6 1/2"  
Curved, Sharp

**F10-080**  
16.5 cm 6 1/2"  
Curved, Sharp

**F10-081**  
16.5 cm 6 1/2"  
Curved, Sharp

**F10-082**  
16.5 cm 6 1/2"  
Curved, Sharp

**Ruck, Ear  
Curette**



! Pictures show the outer diameter





**Billeau  
Ear Loop**

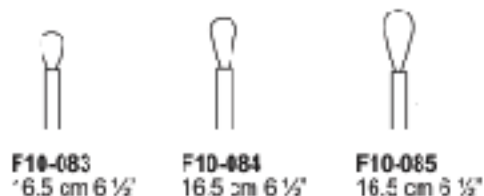

**F10-083**  
16.5 cm 6 1/2"

**F10-084**  
16.5 cm 6 1/2"

**F10-085**  
16.5 cm 6 1/2"



**Lucas  
Hooklet**



**F10-086**  
14 cm 5 1/2"

**F10-087**  
14 cm 5 1/2"

**F10-088**  
14 cm 5 1/2"



**Wagener  
Hooklet Buttoned**



**F10-089**  
14 cm 5 1/2"



**F10-090**  
14 cm 5 1/2"



**F10-091**  
14 cm 5 1/2"



**F10-092**  
14 cm 5 1/2"



**F10-093**  
14 cm 5 1/2"



**F10-094**  
14 cm 5 1/2"



**F10-095**  
14 cm 5 1/2"



**Farrell Applicator**  
**F10-096**  
16.5 cm 6 1/2"  
cross-serrated tip



**Nasal Polypus Snare**  
**F10-097**  
 0.3 mm Ø X 100 mm  
 In bundles of 12 pieces



**Krause Nasal Polypous Snare**  
**F10-098**  
 25.4 cm 10"



**Kraus -Vesco Nasal Polypous Snare**  
**F10-099**  
 25.4 cm 10"  
 With 2 inserts



**Kraus -Wilde Nasal Polypous Snare**  
**F10-100**  
 24 cm 9 1/2"



**F10-101**  
 50CC Complete  
**F10-102**  
 75CC Complete



**Reiner Ear Syringe Tip Only**  
**F10-103**  
 Tip Only



**Reiner Ear Syringe Tip Only**  
**F10-104**  
 Tip Only



**Reiner Ear Syringe Shield**  
**F10-107**

**F10-103**  
 100CC Complete  
**F10-104**  
 150CC Complete  
**Reiner Ear syringe**  
 With Tip & Shield



**Littauer Ear  
Polypus Forceps  
F10-108  
12 cm 4 3/4"**



**Hartmann Ear  
Polypus Forceps  
F10-109  
12 cm 4 3/4"  
Delicate jaw**



**Hartmann Ear  
Polypus Forceps  
F10-110  
14 cm 5 1/2"  
Norma jaw**



**Quire Ear  
Polypus Forceps  
F10-111  
10.5 cm 4 1/4"  
Foreign body lever**



**Buck Ear  
Polypus Forceps  
F10-112  
11.5 cm 4 1/2"  
Foreign body forceps**

<i>Ohrzangchen</i>	<i>Pinzas auriculares</i>
<i>Pinces auriculares</i>	<i>Pinze auricolari</i>



**Hartman  
Ear Forceps  
F10-113**



**Hartmann  
Ear Forceps  
F10-114**  
X = 8.5 cm, 3 1/4"  
**F10-115**  
X = 14 cm, 5 1/2"



**Hartmann  
Ear Forceps  
F10-116**  
X = 8.5 cm, 3 1/4"  
**F10-117**  
X = 14 cm, 5 1/2"  
**F10-118**  
X = 16 cm, 6 1/4"



**Hartmann  
Ear Forceps  
F10-119** 2 mm  $\varnothing$   
X = 8.5 cm, 3 1/4"  
**F10-120** 2.5 mm  $\varnothing$   
X = 8.5 cm, 3 1/4"  
**F10-121** 3 mm  $\varnothing$   
X = 8.5 cm, 3 1/4"



**Hartmann  
Ear Forceps  
F10-122**



**Hartmann-Wullstein  
Ear Forceps  
F10-123**  
X = 8.5 cm, 3 1/4"



**Hartmann-Wullstein  
Ear Forceps  
F10-124**  
1 mm  $\varnothing$   
X = 8.5 cm, 3 1/4"



**Hartmann-Weingartner  
Ear Forceps  
F10-125**  
X = 8.5 cm, 3 1/4"



**Duckbill  
Ear Forceps  
F10-126**



**Weingartner  
Ear Forceps  
F10-127**



**Strumpel  
Ear Forceps  
F10-128**



**Hartmann-Hoffmann  
Ear Forceps  
F10-129**



**Hartmann-Noyes  
Ear Forceps  
F10-130**  
X = 9 cm, 3 1/2"



**Struempel  
Ear Forceps  
F10-131** 0°  
X = 0.5 cm, 3 1/4"



**Struempel  
Ear Forceps  
F10-132** 45°  
X = 0.5 cm, 3 1/4"



**Struempel  
Ear Forceps  
F10-133** 90°  
X = 0.5 cm, 3 1/4"



**MICRO CUP FORCEPS  
F10-134**  
X = 75 mm 3"  
a = 4.0 mm  
b = 1.0 mm  
c = 0.9 mm  
Straight, Oval

**MICRO CUP FORCEPS  
F10-135**  
X = 75 mm 3"  
a = 4.0 mm  
b = 1.0 mm  
c = 0.9 mm  
Curved upwards, Oval

**MICRO CLIP FORCEPS  
F10-136**  
X = 75 mm 3"  
a = 4.0 mm  
b = 1.0 mm  
c = 0.9 mm  
Curved to left, Oval

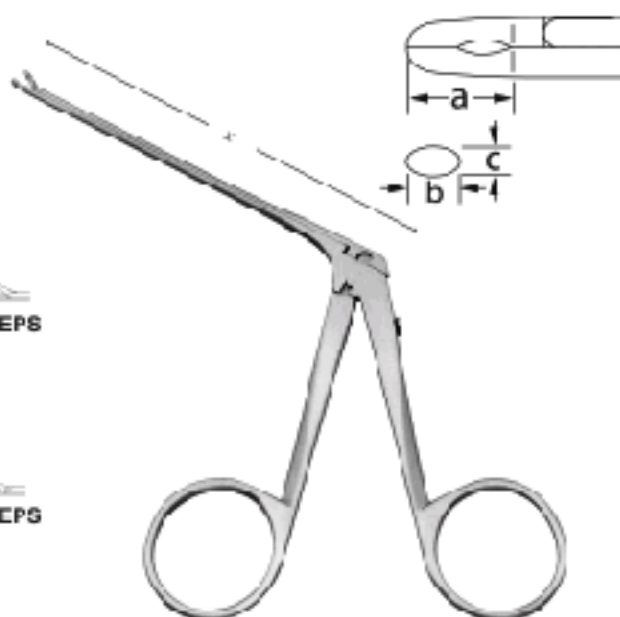

**MICRO CUP FORCEPS**

**MICRO CLIP FORCEPS  
F10-137**  
X = 75 mm 3"  
a = 4.0 mm  
b = 1.0 mm  
c = 0.9 mm  
Curved to right, Oval

**MICRO CLIP FORCEPS  
F10-138**  
X = 75 mm 3"  
a = 4.0 mm  
b = 1.0 mm  
c = 0.9 mm  
Curved downwards, Oval

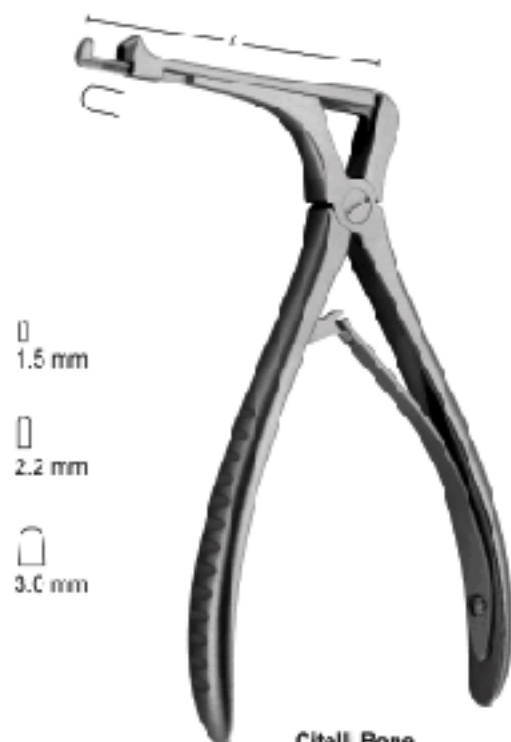

**Citelli Bone  
Ear Rongeurs**  
F10-139  
17 cm 6.34"  
X = 60 mm



**Kerrison Bone  
Ear Rongeurs**  
F10-140  
20 cm 8"  
X = 30 mm

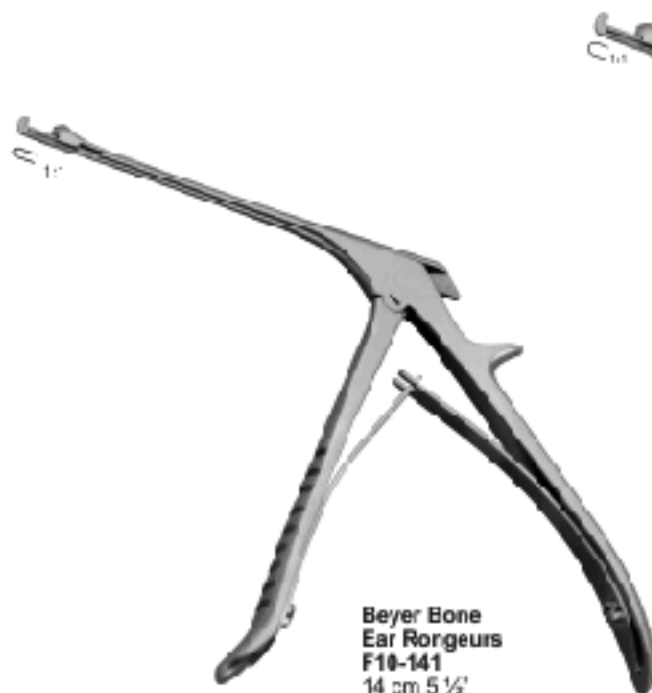

**Beyer Bone  
Ear Rongeurs**  
F10-141  
14 cm 5 1/2"  
1 mm



**Beyer Bone  
Ear Rongeurs**  
F10-142  
19 cm 7 1/2"  
2 mm



**Thudichum  
(Goldsmith)  
Nasal Speculum**



**F10-143**  
6.5 cm 2 1/2"  
21 mm X 9.5 mm



**F10-144**  
6.5 cm 2 1/2"  
21 mm X 10.5 mm



**F10-145**  
6.5 cm 2 1/2"  
21 mm X 11.5 mm



**Hartmann  
Nasal Speculum**



**F10-146**  
16 cm 6 1/4"



**F10-147**  
16 cm 6 1/4"



**F10-148**  
16 cm 6 1/4"



**Hartmann-Halle  
Nasal Speculum**



**F10-149**  
15 cm 6"



**F10-150**  
15 cm 6"



**F10-151**  
15 cm 6"



**Tieck-Halle  
Nasal Speculum**



**F10-152**  
13.5 cm 5 1/4"  
For babies



**Schwarz Nasal Speculum**



**F10-153**  
14 cm 5 1/2"



**Vienna Speculum**  
**F10-154**  
14.6cm 5 3/4"  
medium standard pattern



**Killian Nasal Speculum**



**F10-155**  
13 cm 5"  
X = 35 mm



**F10-156**  
13 cm 5"  
X = 50 mm



**F10-157**  
13 cm 5"  
X = 75 mm

**F10-158**  
13 cm 5"  
X = 90 mm



**Killian Septum Speculum  
F10-159**  
15.2 cm 6"  
2.51 cm blades  
with set screw



**Killian Septum Speculum  
F10-160**  
15.2 cm 6"  
6.9cm 3 1/2 blades  
set screw



**Killian Septum Speculum  
F10-161**  
Fiber Optic 5 1/2" 14.0mm  
length 2.51mm deep



**Beckmann  
Nasal Speculum**



**F10-162**  
15 cm 6"



**F10-163**  
15 cm 6"



**F10-164**  
15 cm 6"



**Mod. Wien  
Nasal Speculum**



**F10-165**  
14.5 cm 5 3/4"



**F10-166**  
14.5 cm 5 3/4"



**F10-167**  
14.5 cm 5 3/4"



**Cottle Nasal Speculum**

**F10-168**  
 15 cm 6"  
 X = 35 mm

**F10-169**  
 15 cm 6"  
 X = 50 mm

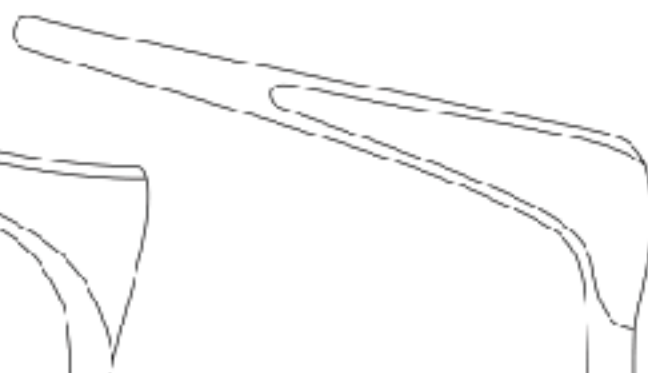
**F10-170**  
 15 cm 6"  
 X = 75 mm

**F10-171**  
 15 cm 6"  
 X = 90 mm

**Cottle Nasal Speculum**

**F10-172**  
 14 cm 5 1/2"  
 X = 45 mm

**F10-173**  
 14 cm 5 1/2"  
 X = 75 mm



**Westmacott Nasal Polypus and Septum Forceps**  
F10-174 20 cm 8"



**Lubet-Jarboon Nasal Polypus and Septum Forceps**  
F10-175 20 cm 8"



**Hartmann Nasal Polypus and Septum Forceps**  
F10-176 16 cm 6 1/4"  
F10-177 20 cm 8"



**Tilley Nasal Polypus and Septum Forceps**  
F10-170 14 cm 5 1/2"



**Heymann-Knight Nasal Polypus and Septum Forceps**  
F10-179 18 cm 7"



**Craig Nasal Polypus and Septum Forceps**  
F10-180 18 cm 7"



**Kright Nasal Polypus and Septum Forceps**  
F10-181 13 cm 7"



**Littauer Nasal Polypus and Septum Forceps**  
F10-182 13 cm 7"



# Nasal Polypus & Nasal Dressing Forceps

Nasenpolypenzangen, Nasentamponzange

Pinças para pólipos nasales, Pinza nasale para tamponamento

Pinces à polypes nasales, Pince à pansement pour le nez

Pinze per polipi nasalì, Pinza per tamponamento nasale



Haymann Nasal Dressing Forceps

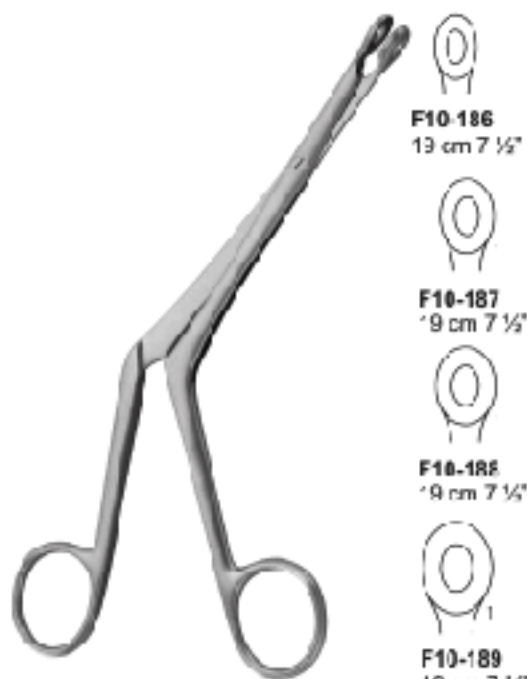

Brønning's Nasal Cutting Forceps

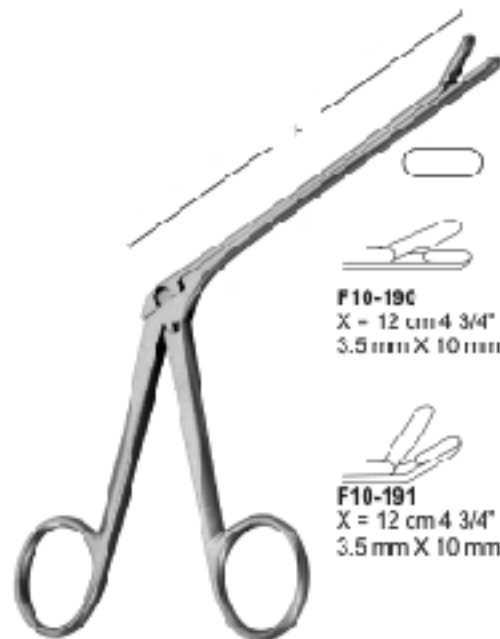

Takahashi Nasal Cutting Forceps



Noyes Nasal Dressing Forceps  
F10-182  
X = 11 cm 3 1/2"  
1 X 2

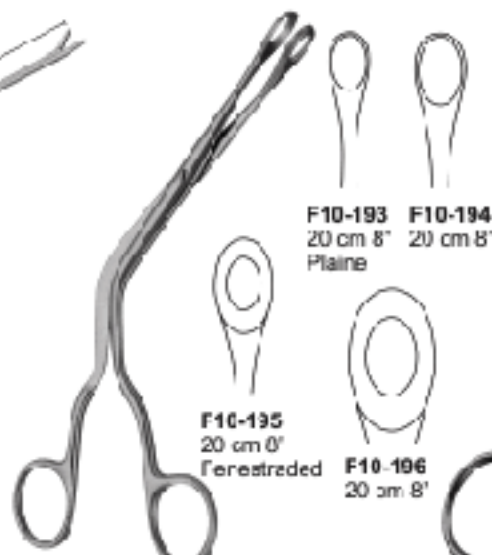

Luc Nasal Cutting Forceps



Well Nasal Cutting Forceps  
F10-197  
X = 12 cm 4 3/4"

Watson-Williams Nasal Cutting Forceps  
F10-198  
X = 12 cm 4 3/4"

F10-199  
X = 12 cm 4 3/4"



**Freer  
Tonsil Knife  
F10-200**  
21 cm 8 1/4"



**Freer  
Tonsil Knife  
F10-201**  
21 cm 8 1/4"



**Tonsil Knife  
F10-202**  
20 cm 8"  
Sharp



**Tonsil Knife  
F10-203**  
20 cm 8"  
Gickle knife



**Bruenings  
Tonsil Knife  
F10-204**  
23 cm 9"



**Abraham  
Tonsil Knife  
F10-205**  
22 cm 8 3/4"



**Fischer Tonsil  
Knife and Dissector  
F10-206**  
21.6 cm 8 1/2"  
semi sharp tip, with teeth



**EVE Tonsil Snare**  
27.9 cm 11"  
**F10-207** without ratchet  
**F10-208** with ratchet

*Septumelevatoren - Raspatorien*
*Elevadores - legras para el tabique nasal*
*Elevateurs - rugines pour la cloison nasale*
*Elevatori - pericostotomi per setto*

**Lempert  
Septum  
Elevators  
Raspatory  
F10-209**  
20.5 cm 8"  
X = 6 mm



**Lempert  
Septum  
Elevators  
Raspatory  
F10-210**  
18 cm 7"  
X = 5 mm



**Cottle  
Septum  
Elevators  
Raspatory  
F10-211**  
19 cm 7 1/2"  
X = 3 mm  
Sharp



**Joseph  
Septum  
Elevators  
Raspatory  
F10-212**  
16 cm 6 1/4"  
X = 5 mm  
Periosteal elevators



**Joseph-Masing  
Septum Elevators  
Raspatory  
F10-213**  
21.5 cm 8 1/2"  
Sharp



**Pennington  
Septum  
Elevators  
Raspatory  
F10-214**  
21.5 cm 8 1/2"  
Blunt



**Freer  
Septum  
Elevators  
Raspatory  
F10-215**  
19 cm 7 1/2"  
Blunt



**Freer  
Septum  
Elevators  
Raspatory  
F10-216**  
18 cm 7"  
Sharp/Blunt



**Freer  
Septum  
Elevators  
Raspatory  
F10-217**  
20.5 cm 8"  
Sharp/Blunt



**Cottle  
Septum  
Elevators  
Raspatory  
F10-218**  
23.5 cm 9 1/4"  
X = 5 mm  
Sharp

*Periostelevatorien, Septum-elevatorien*
*L'agras para periostio, Elevadores para el tabique nasal*
*Elevateurs pour la périoste, Elevateurs pour la cloison nasale*
*Elevatori per il periostio, Elevatori per setto*

**Masing Periosteal  
Septum Elevators**  
F10-219  
20 cm 8"



**Ballenger-Hajek  
Periosteal Septum Elevators**  
F10-220  
19 cm 7 1/4"  
F10-221  
22 cm 8 3/4"



**Cottle Periosteal  
Septum Elevators**  
F10-222  
22 cm 8 3/4"



**Cottle Periosteal  
Septum Elevators**  
F10-223  
21 cm 8 1/4"

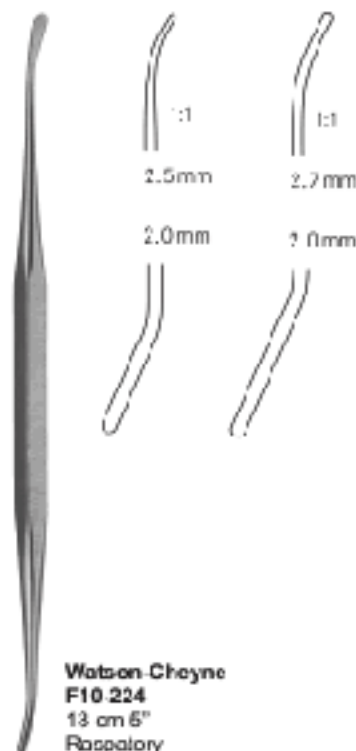

**Watson-Cheyne**  
F10-224  
13 cm 5"  
Raspatory



**Boies**  
F10-225  
19 cm 7 1/2"  
Nasal fracture elevator,  
Blunt



**Goldman**  
F10-226  
17 cm 6 3/4"  
Septum displacer

*Nasensågen*  
*Scies nasales*

*Sirerras nasales*  
*Seghe nasali*



**Joseph Nasal Saw**  
**F10-227**  
19 cm 7 1/2"



**Joseph Nasal Saw**  
**F10-228**  
19 cm 7 1/2"



**Joseph Nasal Saw**  
**F10-229**  
19 cm 7 1/2"



**Maltz Rasp**  
**F10-230**  
21 cm 8-1/4"  
improved double end  
pattern, forward and  
backward cutting



**Joseph Rasp**  
**F10-231**  
15.9 cm 6-1/4"  
fine cross serrations



**Joseph Nasal Saw**  
**F10-232**  
17 cm 6 3/4"

**Joseph Nasal Saw**  
**F10-233**  
17 cm 6 3/4"

*Raspeln mit Hartmetall*
*Rapes avec inserts de carbure de tungstene*
*limas con carburo de tungsteno*
*raspe con tungsteno*

**Fomon  
Rasp with  
Tungsten  
Carbide**



**F10-234**  
20 cm 8"  
Teeth 17



**F10-235**  
20 cm 8"  
Teeth 16



**F10-236**  
20 cm 8"  
Teeth 24



**F10-237**  
20 cm 8"  
Teeth 36



**F10-238**  
20 cm 8"  
Teeth 52



**Fomon Rasp  
with Tungsten  
Carbide TC**



**F10-239**  
20 cm 8"  
Teeth 14



**F10-240**  
20 cm 8"  
Teeth 20



**F10-241**  
20 cm 8"  
Teeth 30



**F10-242**  
20 cm 8"  
Teeth 44



**F10-243**  
20 cm 8"  
Teeth 32



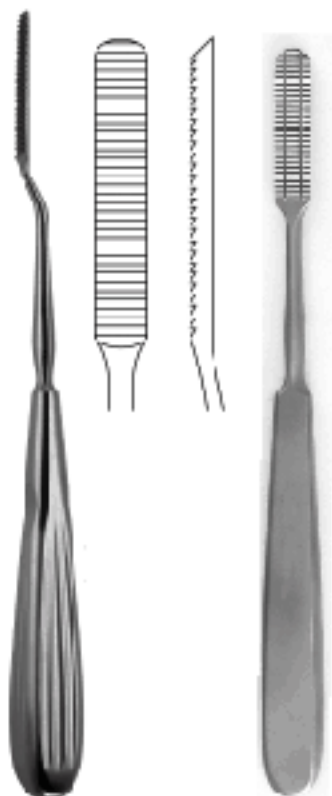

**Cottle Nasal Saw**  
F10-244  
21 cm 8 1/4"

**Maltz Nasal Saw**

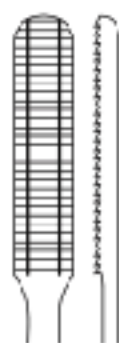

**F10-245**  
17 cm 6 3/4"  
34 mm x 7 mm  
Pushing out



**F10-246**  
17 cm 6 3/4"  
34 mm x 7 mm  
Drawing out



**Auricht Nasal Saw**  
Glabella Rasp,  
backward cutting



**F10-247**  
21 cm 8 1/4"  
Pushing out



**F10-248**  
21 cm 8 1/4"  
Drawing out



**Maltz Nasal Saw**



**F10-249**  
17.5 cm 7"  
40 mm X 9 mm



**Wiener Nasal Saw**

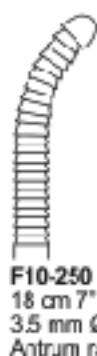

**F10-250**  
18 cm 7"  
3.5 mm Ø  
Antrum rasps



**F10-251**  
18 cm 7"  
3.5 mm Ø  
Antrum rasps



**Gallahor Nasal Saw**



**F10-252**  
16 cm 6 1/4"



**F10-253**  
16 cm 6 1/4"



**F10-254**  
16 cm 6 1/4"



**Fomon  
Nasal Saw**  
F10-255  
21 cm 8 1/4"





**Bruenings-Brunk**  
**F10-256**  
 19 cm 7 1/2"  
 Antrum Retractor  
 Serrated



**Ritter-Halle**  
**F10-257** 16 cm 6 1/4"  
 2.5 mm Ø  
**F10-258** 16 cm 6 1/4"  
 3.0 mm Ø  
**F10-259** 16 cm 6 1/4"  
 4.0 mm Ø  
 Frontal sinus hook

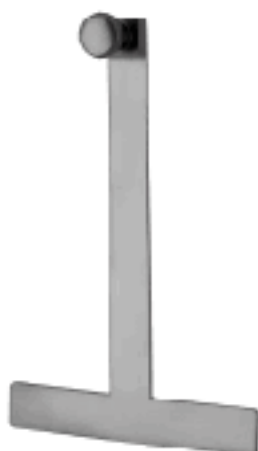

**Cottle**  
**F10-260**  
 1.2 cm 4 3/4"  
 Handle



**Cottle**  
**F10-261**  
 7 mm  
 Guide support  
 for osteotomes

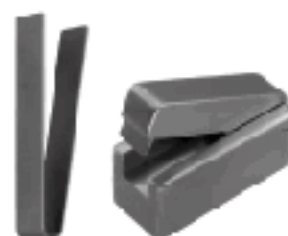

**Cottle**  
**F10-262**  
 65 mm X 30 mm X 30 mm  
 Cartilage crusher



**Cottle-Walsham**  
**Septum Forceps**



**F10-263**  
 23 cm 9"  
 Straight



**F10-264**  
 23 cm 9"  
 Left



**F10-265**  
 23 cm 9"  
 Right



**Ash Septum**  
**Forceps**  
**F10-266**  
 23 cm 9"



*Septumzangen*
*Pinces pour le cloison nasale*
*Pinzas para el tabique nasal*
*Pinze per il setto nasale*

**Middleton-Jansen  
Septum Forceps  
F10-267  
19 cm 7 1/2"**



**Middleton-Jansen  
Septum Forceps  
F10-268  
19 cm 7 1/2"**

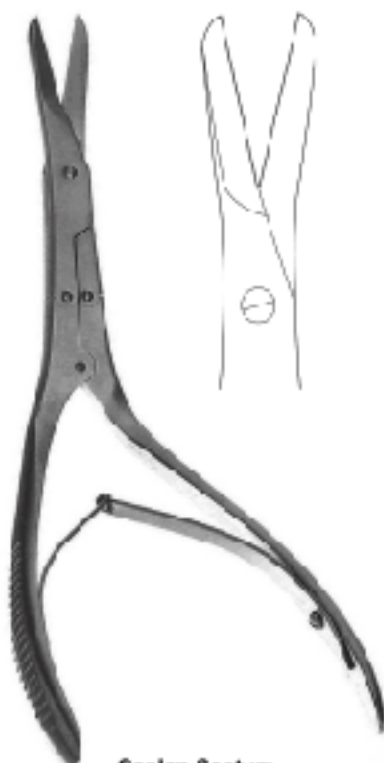

**Caplan Septum  
Forceps  
F10-259  
20 cm 8"  
Toothed**



**Rubin Septum  
Forceps  
F10-270  
21 cm 8 1/4"  
Protection cap**

**F10-271**  
21 cm 8 1/4"

**F10-272**  
21 cm 8 1/4"

**F10-275**  
22 cm 8 3/4"

**F10-276**  
22 cm 8 3/4"

**F10-273**  
21 cm 8 1/4"

**F10-274**  
21 cm 8 1/4"

**F10-277**  
22 cm 8 3/4"

**F10-278**  
22 cm 8 3/4"

**Barnhill**  
Adenoid Curette

**St. Clair-Thomson**  
Adenoid Curette

**Beckmann**  
Adenoid Curette

**F10-279**  
22 cm 8 3/4"  
Straight

**F10-280**  
22 cm 8 3/4"  
Straight

**F10-281**  
22 cm 8 3/4"  
Straight

**F10-282**  
22 cm 8 3/4"  
Straight

**F10-283**  
22 cm 8 3/4"  
Straight

**F10-284**  
22 cm 8 3/4"  
Straight

**Beckman**  
Adenoid Curette

**F10-285**  
22 cm 8 3/4"  
Curved

**F10-286**  
22 cm 8 3/4"  
Curved

**F10-287**  
22 cm 8 3/4"  
Curved

**F10-288**  
22 cm 8 3/4"  
Curved

**F10-289**  
22 cm 8 3/4"  
Curved

**F10-290**  
22 cm 8 3/4"  
Curved

**La Force**

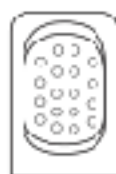

La Force  
adenotome  
unperforated  
Fig 1  
**F10-291**  
21.6 cm 8 1/2"  
25 x 15.0mm  
Infant



La Force  
adenotome  
perforated  
Fig 1  
**F10-292**  
21.6 cm 8 1/2"  
25 x 16.3mm  
Infant

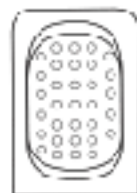

La Force  
adenotome  
unperforated  
Fig 2  
**F10-293**  
24.1 cm 9 1/2"  
26 x 19.3mm  
Medium



La Force  
adenotome  
perforated  
Fig 2  
**F10-294**  
24.1 cm 9 1/2"  
26 x 19.3mm  
Medium

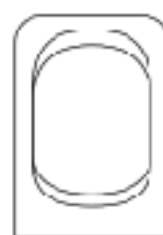

La Force  
adenotome  
unperforated  
Fig 3  
**F10-295**  
25 cm 10"  
30 x 22.2mm  
Large

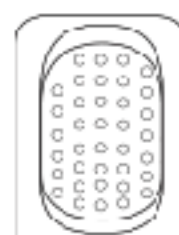

La Force  
adenotome  
perforated  
Fig 3  
**F10-296**  
25 cm 10"  
30 x 22.2mm  
Large



**F10-297**  
20 cm 8"  
X = 3 mm  
Straight  
**F10-298**  
20 cm 8"  
Straight  
X = 4 mm  
**F10-299**  
20 cm 8"  
Straight  
X = 5 mm

**Bailenger Knifs**

**F10-300**  
20 cm 8"  
X = 3 mm  
Bayonet  
**F10-301**  
20 cm 8"  
Bayonet  
X = 4 mm  
**F10-302**  
20 cm 8"  
Bayonet  
X = 5 mm

**Bailenger Knifs**

**Wicder Tongue Depressor**  
**F10-303** large blade 38mm  
wide corrated

**Wicder Tongue Depressor**  
**F10-304** 43.5mm width blade

**Whitehead  
Mouth Gag**

F10-305 11 cm 4 1/4"  
F10-306 13 cm 5"  
F10-307 15 cm 6"

**Jeanings  
Mouth Gag**

F10-308 9 cm 3 1/4"  
F10-309 11 cm 4 1/4"  
F10-310 13 cm 5"  
F10-311 16 cm 6"



**Heister  
Mouth Gag**  
F10-312  
12 cm 5"



**Moulder  
Mouth Gag**  
F10-313  
10 cm 4"  
4 mm Ø  
Wood



**Molt Mouth Gag**  
F10-314  
11 cm 4 1/4"  
For children



**Molt Mouth Gag**  
F10-315  
14 cm 5 1/2"  
For adults



**Denhart  
Mouth Gag**  
F10-316  
12 cm 4 3/4"



**Fergusson-Ackland  
Mouth Gag**  
F10-317  
14.5 cm 5 3/4"



**Roser-Konig  
Mouth Gag**  
F10-318  
13 cm 6 1/4"  
F10-319  
19 cm 7 1/2"



**Jackson**  
F10-320  
22 cm 8 3/4"  
Laryngeal forceps



**Marschik**  
F10-321  
22 cm 8 3/4"  
Tonsil seizing forceps



**Blohmke**  
Tonsil  
Forceps  
F10-322  
20 cm 8"



**Colver Tonsil**  
Forceps  
F10-323  
19 cm 7 1/2"  
Straight  
F10-324  
19 cm 7 1/2"  
Curved



**White Tonsil**  
Seizing Forceps  
F10-325  
19.1 cm 7 1/2"  
F10-326  
23 cm 9"



**Museux**  
Tonsil Holding Forceps  
F10-327 20 cm 8"



**Wilde Nasal  
Dressing Forceps**  
F10-328  
16.5cm 3 1/2"  
angular



**Troeltsch  
Dressing Forceps**  
F10-329  
11cm, 4 1/2"



**Troeltsch  
Dressing Forceps**  
F10-330  
13 cm, 5"



**Lucas Dressing  
Forceps**  
F10-331  
14 cm, 5 1/2"



**Jansen Dressing  
Forceps**  
F10-332  
16 cm, 6 1/2"



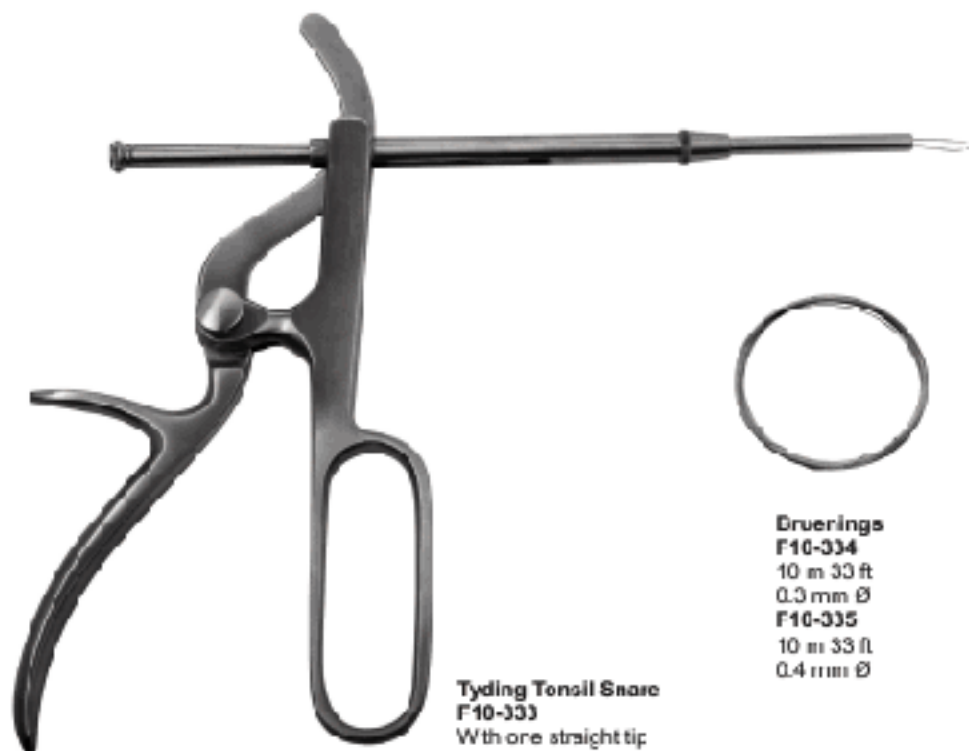

**Tying Tonsil Snare**  
**F10-333**  
 With one straight tip



**Bruenings**  
**F10-334**  
 10 m 33 ft  
 0.3 mm Ø  
**F10-335**  
 10 m 33 ft  
 0.4 mm Ø



**Bruenings**  
**F10-336**  
 40 mm  
 Package of 100 pieces  
**F10-337**  
 50 mm  
 Package of 100 pieces

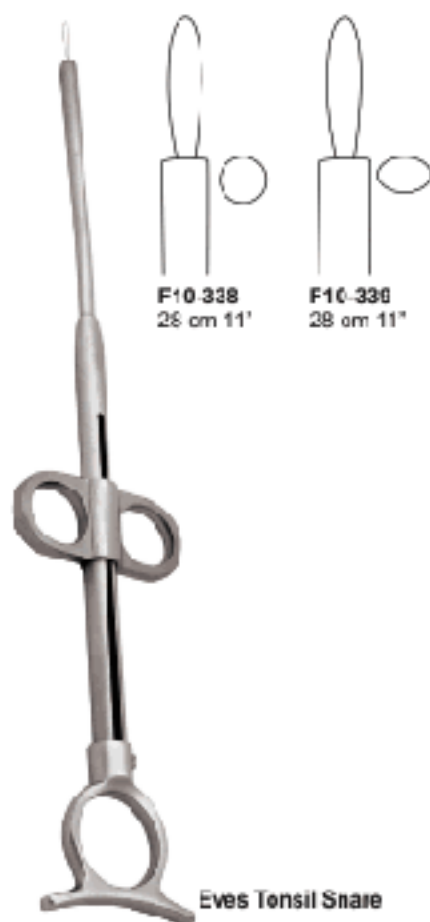

**F10-338**  
 28 cm 11"

**F10-336**  
 28 cm 11"

**Eves Tonsil Snare**



**F10-340**  
 28 cm 11"

**Eves Tonsil Snare**



**F10-341**  
 28 cm 11"

**Bruenings**  
**Tonsil Snare**



- F10-342 6 mm Ø
- F10-343 10 mm Ø
- F10-344 12 mm Ø
- F10-345 14 mm Ø
- F10-346 16 mm Ø
- F10-347 18 mm Ø
- F10-348 20 mm Ø
- F10-349 22 mm Ø
- F10-350 24 mm Ø
- F10-351 26 mm Ø
- F10-352 28 mm Ø
- F10-353 30 mm Ø

Laryngeal mirrors



Laryngeal Mirrors  
Handle  
F10-354  
10 cm 4"



- F10-355 8 mm Ø
- F10-356 10 mm Ø
- F10-357 12 mm Ø
- F10-358 14 mm Ø
- F10-359 15 mm Ø
- F10-360 18 mm Ø
- F10-361 20 mm Ø
- F10-362 22 mm Ø
- F10-363 24 mm Ø
- F10-364 25 mm Ø
- F10-365 28 mm Ø
- F10-366 30 mm Ø

Laryngeal Mirrors  
with Handle



- F10-357 10 mm Ø
- F10-358 12 mm Ø
- F10-359 14 mm Ø
- F10-370 16 mm Ø
- F10-371 18 mm Ø

Michel Movable  
Mirror

*Trachealdilatatoren, Trachealkanülen*
*Dilatadores para la traqueotomía, Canúlas para la traquea*
*Dilateurs pour la trachéotomie, Canules pour la trachéotomie*
*Dilatatori tracheali, Canbyke tracheali*

**Laborde Trachea Dilator 3 Prong**  
F10-372  
14 cm 5 1/2"

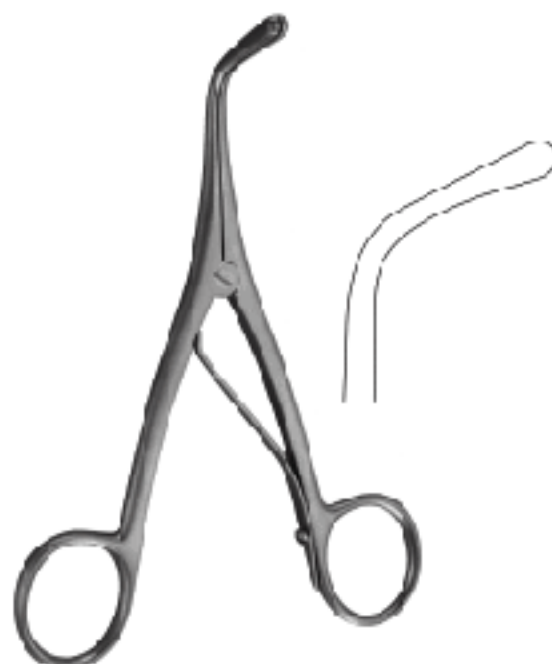

**Trousseau Trachea Dilator 2 Prong**  
F10-373  
14 cm 5 1/2"



**Uckermann Trachea Tubes**  
F10-374  
13 cm 5"  
10 mm Ø



**Luer-Standard Trachea Tubes**  
German silver

F10-375 4 mm Ø  
F10-376 5 mm Ø  
F10-377 5 mm Ø  
F10-378 7 mm Ø  
F10-379 8 mm Ø  
F10-380 9 mm Ø  
F10-381 10 mm Ø  
F10-382 11 mm Ø  
F10-383 12 mm Ø  
F10-384 13 mm Ø



**Chevalier-Jackson Trachea Tubes**  
German silver

F10-385 4 mm Ø  
F10-386 5 mm Ø  
F10-387 6 mm Ø  
F10-388 7 mm Ø  
F10-389 8 mm Ø  
F10-390 9 mm Ø  
F10-391 10 mm Ø  
F10-392 11 mm Ø  
F10-393 12 mm Ø  
F10-394 13 mm Ø



**Jako-Cherry Micro Laryngoscope**  
**F10-385**  
 Type II, Newborn  
 Small, Overall length 114mm  
 min. I.D. 7.8mm



**Carlens Medialastroscope, Short**  
**F10-386**  
 Overall length 116mm, min. I.D. 10.8mm,  
 nominal proximal dims 16.0mm, max O.D. 18.8mm



**Carlens Medialastroscope, Long**  
**F10-387**  
 Overall length 162mm, min. I.D. 11.0mm,  
 nominal proximal dims 19.0mm, max O.D. 22.3mm



**Carlens Medialastroscope, Extra-long**  
**F10-388**  
 Overall length 191mm, min. I.D. 11.9mm,  
 nominal proximal dims 19.0mm, max O.D. 22.3mm



**Tucker Mid-Lighted Side Slide Laryngoscope**  
**F10-399**  
 Overall length 91mm, min. I.D. 6.9mm

**Tucker Mid-Lighted Side Slide Laryngoscope, Acolascent**  
**F10-400**  
 Overall length 106mm, min. I.D. 9.3mm



**Tucker Mid-Lighted Side Slide Laryngoscope**  
**F10-401 Adult**  
 Overall length 121mm, min. I.D. 10.7mm

**Tucker Mid-Lighted Side Slide Laryngoscope**  
**F10-402 Adult Long**  
 Overall length 150mm, min. I.D. 11.8mm

(Note) Required size available on Demand

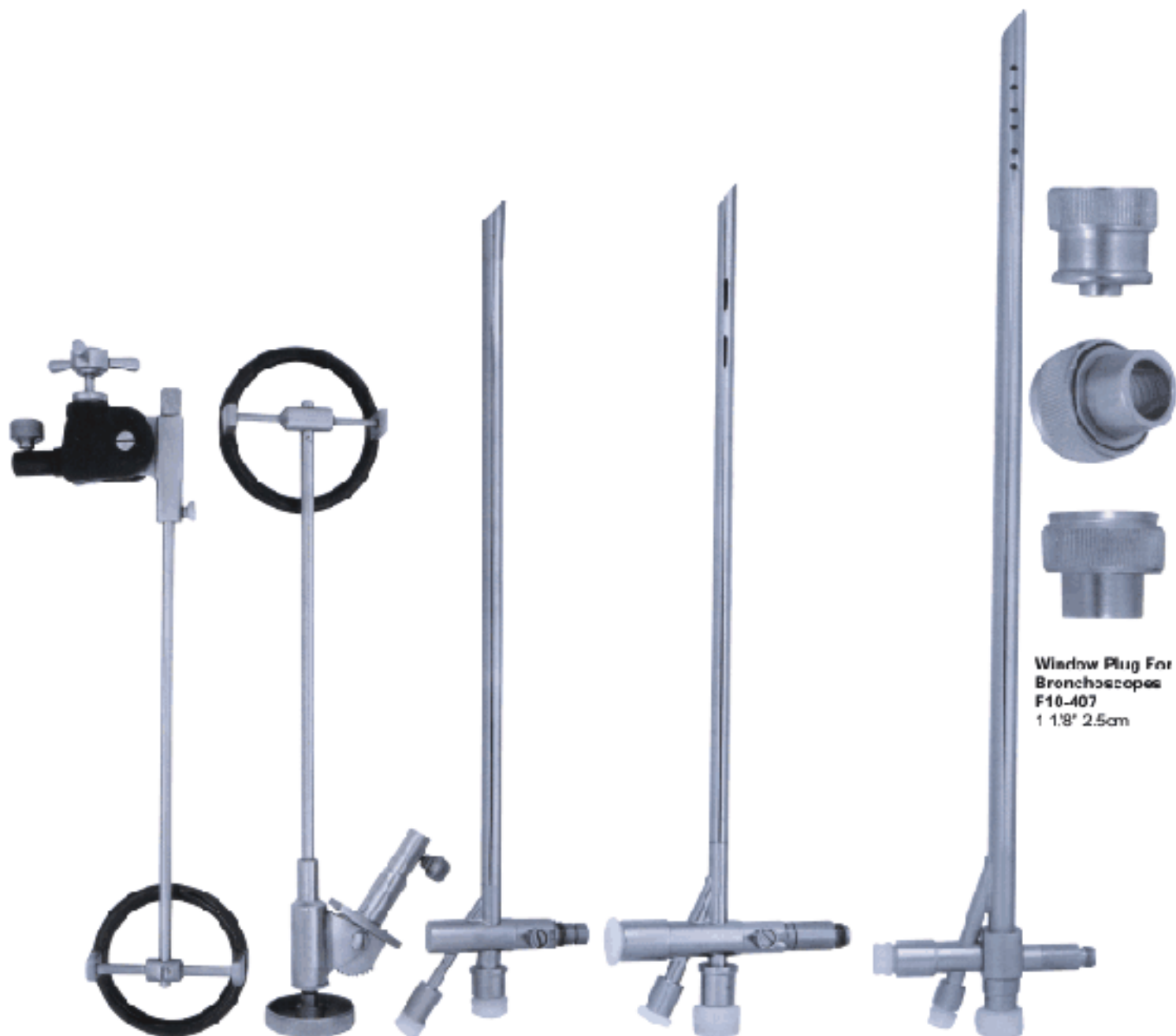

**Laryngoscope Holder  
F10-403**  
Chest Support  
complete, for adults and children

**Holinger Bronchoscope  
F10-404 3X20**  
Infant, Scope size 3 x 20,  
overall length 203mm,  
min. I.D. 2.9mm

**Holinger Bronchoscope  
F10-405 3.5X20**  
Infant, Scope size 3.5 x 20,  
overall length 203mm, min.  
I.D. 3.5mm

**Holinger Bronchoscope  
F10-406 9X40**  
Scope size 9 x 40  
overall length 400mm,  
min. I.D. 8.5mm

**Window Plug For  
Bronchoscopes  
F10-407**  
1 1/8" 2.5cm



## LARYNGEAL POLYPUD FORCEPS

*Kehkryjpolypenzangen*

*Pinzas para polipos laríngens*

*Pinces a polypes laríngens*

*Pinze per polipi laríngei*

**Jesburg Esophagoscope**  
F10-408 6 x 8 x 32, Overall  
length 317mm,  
mir. I.D. 5.1mm

**Jesburg Esophagoscope**  
F10-409 6.5 x 10 x 35, Overall  
length 349mm,  
mir. I.D. 5.5mm

**Jesburg Esophagoscope**  
F10-410 7 x 10 x 42, Overall  
length 421mm,  
mir. I.D. 5.0mm

**Suction Tube**  
F10-411  
with fix head

**Fenestrated Cupped  
Grasping Forceps**  
F10-412

**Frazier Suction Tube**  
F10-413  
11 French tip, Working  
length 19cm (7 1/2")



# NEUROSURGERY

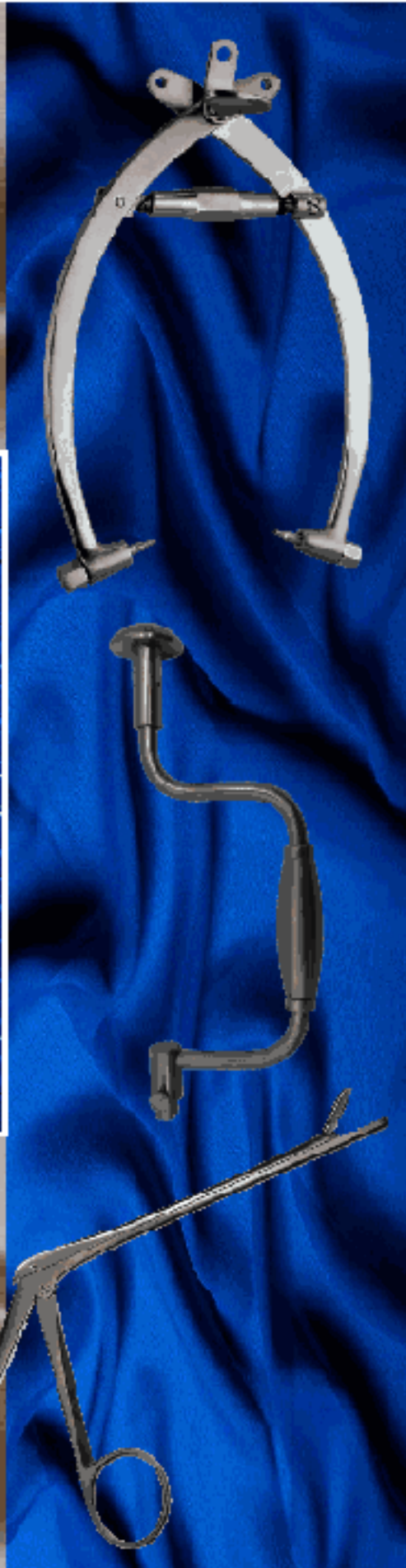
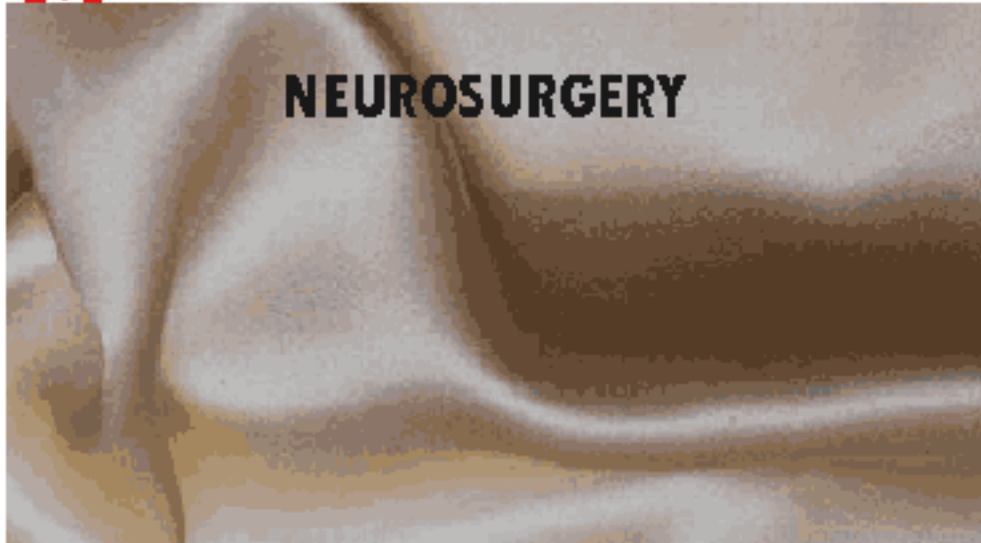



**Crutchfield  
Traction tongs  
F11-001 13cm  
small**



**Crutchfield drill bit  
F11-002 3.5mm**



**Crutchfield drill bit  
F11-003 5.0mm**

Set of 2 Pieces for  
F11-001 and F11-004



**Crutchfield  
Traction tongs  
F11-004 18.5cm**



**Crutchfield Skull  
F11-005**  
large type, cervical traction  
tongs-pins adjustable no drilling  
to be done 11cm



**F11-005**  
Wrench double  
ended for F11-005



**De Martel  
Saw Conductor  
F11-007  
33cm 13"**



**Adson  
Drill guide  
F11-000  
15cm 6"**



**De Vibiss  
Skull Forceps  
F11-009  
20cm 8 1/4"**



**Olivecrona  
Wire Saw  
F11-010 30cm 12"  
F11-011 40cm 16"  
F11-012 50cm 20"  
F11-013 60cm 23 1/2"  
F11-014 70cm 27 1/2"**



**Gigle, Wire Saw  
F11-015 30cm 12"  
F11-016 40cm 16"  
F11-017 50cm 20"  
6 wires twisted**



**Gigle-Strully  
Handle for  
wire saw  
F11-013**





**Supra Cut Distraction Screw**  
 F11-019 12mm Non Sterile  
 F11-020 14mm Non Sterile  
 F11-021 16mm Non Sterile  
 F11-022 18mm Non Sterile  
 F11-023 12mm Sterile  
 F11-024 14mm Sterile  
 F11-025 16mm Sterile  
 F11-026 18mm Sterile



**Supra Cut Distraction Screw Driver**  
 F11-027



**Cushing, brain spatula**  
 F11-028 7mm x 9mm  
 F11-029 11mm x 13mm  
 F11-030 15mm x 18mm  
 F11-031 18mm x 22mm  
 18cm 7"



**Oliverson**  
 F11-032  
 brain spatula  
 16cm 7"



**Brain Spatula**  
 F11-033 7mm x 9mm  
 F11-034 11mm x 13mm  
 F11-035 15mm x 18mm  
 F11-036 18mm x 22mm  
 18cm 7", Convex



**Brain Spatula**  
 F11-037 7mm x 9mm  
 F11-038 11mm x 13mm  
 F11-039 15mm x 18mm  
 F11-040 18mm x 22mm  
 18cm 7", Concave



**Heifetz, brain spatula**  
 F11-041 8mm  
 F11-042 11mm  
 F11-043 14mm  
 F11-044 17mm  
 F11-045 20mm  
 20cm 8", Malleable



**F11-046**  
16cm 6"  
**F11-047**  
16cm 7 1/2"  
Straight



**F11-048**  
16cm 6"  
**F11-049**  
16cm 7 1/2"  
Curved



**McKenzie**  
**F11-050** 148mm x 40mm x 6mm  
5 3/4" x 1 5/8" x 1/4", Brain clip rack for 20 clips



**McKenzie Clip Applying**  
**Forceps**  
**F11-051**  
Straight Handle, Curved  
Jaws, 6"



**McKenzie Clip Applying**  
**Forceps**  
**F11-052**  
Curved Handle, Curved  
Jaws, 6"



**Smithwick Clip Applying**  
**Forceps**  
**F11-053**  
9", Curved Jaws  
Straight Handle



**Smithwick Clip Applying**  
**Forceps**  
**F11-054**  
10 1/2", Curved Jaws  
Straight Handle



**Smithwick Clip Applying**  
**Forceps**  
**F11-055**  
10 1/2", Straight Jaws  
Straight Handle



**Schwartz Clip Applying Forceps**  
**F11-056** 20.3cm 8"  
**Schwartz Vessel Clip**



**F11-057** 1" (2.5cm), Straight Jaws 1.7x 6mm  
**F11-058** 1" (2.5cm), Slightly Angled Jaws 1.7x 8mm  
**F11-059** 1" (2.5cm), Strong Angled Jaws 1.7x 8mm

*Nemenhaken - Durahaken*
*Ganchos para nervios - Ganchos para duramadre*
*Crochets a nerfs - Crochets pour duremers*
*Uncini per nervi - Uncini per duramadre*

**F11-060**  
15cm 6"

**F11-061**  
19cm 7 1/2"

**Teemis Nerve  
Dura Hook**

**Haller Nerve  
Dura Hook**  
**F11-062**  
23cm 8"

**Smithwick Nerve  
Dura Hook**  
**F11-063** 17cm 6 3/4"  
**F11-064** 21cm 8 1/4"

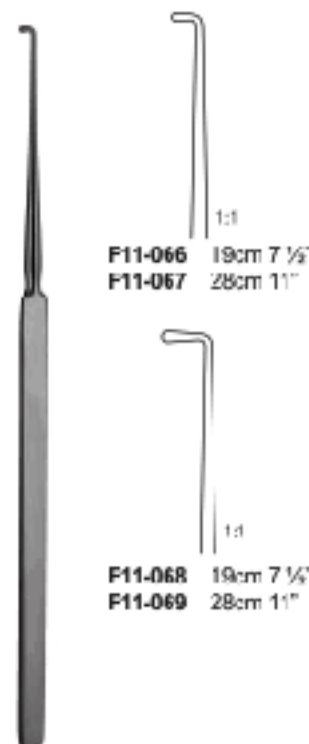
**Hoen Nerve  
Dura Hook**  
**F11-065**  
22cm 8 3/4"

**F11-066** 19cm 7 1/2"  
**F11-067** 28cm 11"

**F11-068** 19cm 7 1/2"  
**F11-069** 28cm 11"

**Cushing Nerve  
Dura Hook**
**DURA DISSECTORS**

**Penfield Dura  
Dissector**  
**F11-070**  
17.5cm 7"

**Penfield Dura  
Dissector**  
**F11-071**  
19.5cm 7 3/4"

**Penfield Dura  
Dissector**  
**F11-072**  
19.5cm 7 3/4"

**Penfield Dura  
Dissector**  
**F11-073**  
19.5cm 7 3/4"

**Penfield Dura  
Dissector**  
**F11-074**  
19.5cm 7 3/4"

Nemmenhaken - Durahaken

Ganchos para nervios - Ganchos para duramadre

Crochets a nerfs - Crochets pour duremers

Uncini per nerri - Uncini per duramadre



**Love Nerve Dura  
Hook Retractor**  
F11-075  
19cm 7 1/2"  
Straight



**Love Nerve Dura  
Hook Retractor**  
F11-076  
19cm 7 1/2"  
45° Angled



**Love Nerve Dura  
Hook Retractor**  
F11-077  
19cm 7 1/2"  
90° Angled



**Cushing Nerve Dura  
Hook Retractor**  
F11-078  
14cm 5 1/2"



**Frazier Nerve Dura  
Hook Retractor**



**F11-079**  
13cm 5"  
**F11-080**  
18cm 7"  
Sharp



**F11-081**  
13cm 5"  
**F11-082**  
18cm 7"  
Blunt



**Lahey Nerve Dura  
Hook Retractor**  
F11-083  
13cm 5"



**Yasargil Nerve Dura  
Hook Retractor**  
F11-084 21cm 12 1/4"  
F11-085 41cm 16 1/4"  
Galea retractor



**Toennis Dura  
Dissector**  
F11-086  
25cm 9 3/4"



**Davis Dura  
Dissector**  
F11-087  
24.5cm 9 3/4"



**Dura Dissector**  
F11-008  
22cm 8 3/4"



**Sachs Dura  
Dissector**  
F11-089  
21cm 8 1/4"



**Sachs Dura  
Dissector**  
F11-090  
21cm 8 1/4"



**Sachs Dura  
Dissector**  
F11-091  
21cm 8 1/4"

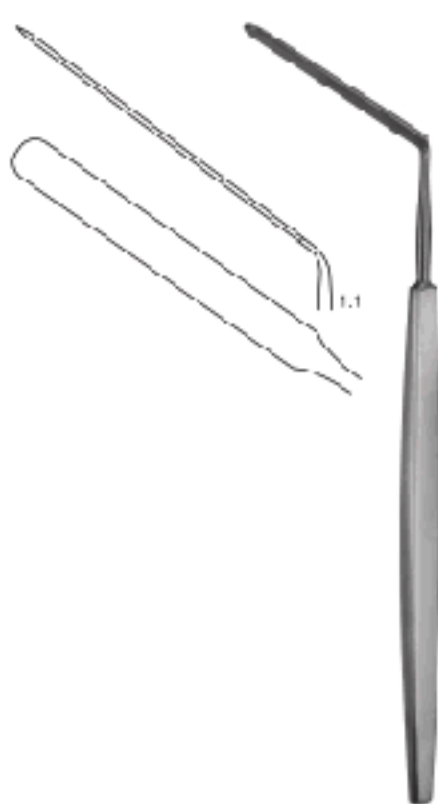

**Horsley Dura  
Dissector**  
F11-092  
20cm 8"

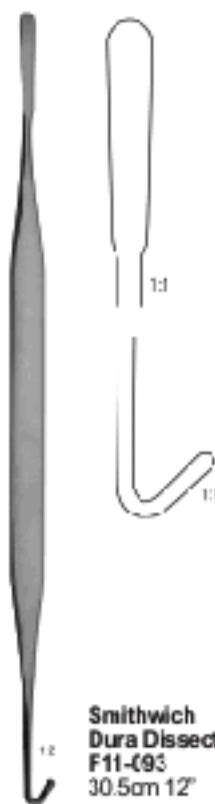

**Smithwich  
Dura Dissector**  
F11-093  
30.5cm 12"

**Cushing Intervertebral Disc Rongeurs**

2 X 10mm, 6"	2 X 10mm, 9"
F11-094 straight	F11-106 straight
F11-095 UP	F11-107 UP
F11-096 Down	F11-108 Down

1.5 X 10mm, 7"	2 X 10mm, 10"
F11-097 straight	F11-109 straight
F11-098 Up	F11-110 UP
F11-099 Down	F11-111 Down

2 X 10mm, 7"	2 X 10mm, 11"
F11-100 straight	F11-112 straight
F11-101 UP	F11-113 UP
F11-102 Down	F11-114 Down

1.5 X 10mm, 9"	2 X 10mm, 12"
F11-103 straight	F11-115 straight
F11-104 Up	F11-116 UP
F11-105 Down	F11-117 Down

**Love-Greenwald Intervertebral Disc Rongeurs**

3 X 10mm, 5"	3 X 10mm, 10"
F11-118 straight	F11-127 straight
F11-119 Up	F11-128 Lp
F11-120 Down	F11-129 Down

3 X 10mm, 7"	3 X 10mm, 11"
F11-121 straight	F11-130 straight
F11-122 Up	F11-131 Lp
F11-123 Down	F11-132 Down

3 X 10mm, 9"	3 X 10mm, 12"
F11-124 straight	F11-133 straight
F11-125 Up	F11-134 Lp
F11-126 Down	F11-135 Down

**Spurling Intervertebral Disc Rongeurs**

4 X 10mm, 6"	4 X 10mm, 10"
F11-136 straight	F11-145 straight
F11-137 Up	F11-146 Up
F11-138 Down	F11-147 Down

4 X 10mm, 7"	4 X 10mm, 11"
F11-139 straight	F11-148 straight
F11-140 Up	F11-149 Up
F11-141 Down	F11-150 Down

4 X 10mm, 9"	4 X 10mm, 12"
F11-142 straight	F11-151 straight
F11-143 Up	F11-152 Up
F11-144 Down	F11-153 Down

**Micro Cup Forceps**

5.5", 0.5mm  
 F11-154 Straight  
 F11-155 Right  
 F11-156 Left

**Micro Cup Forceps**

5.5", 1mm  
 F11-157 Straight  
 F11-158 Right  
 F11-159 Left



5.5", 2mm  
 F11-160 Straight

**Micro Cup Forceps**

6", 200mm, 2mm  
 F11-151 Straight  
 F11-152 Up  
 F11-153 Down



**Wilde Intervertebral Disc Rongeurs**

7° Straight

 F11-164 2.5mm  
 F11-165 3mm  
 F11-166 4mm  
 F11-167 5mm

7° Angled Up

 F11-168 2.5mm  
 F11-169 3mm  
 F11-170 4mm  
 F11-171 5mm

9° Straight

 F11-172 3mm  
 F11-173 4mm  
 F11-174 5mm

**Caspar Type Intervertebral Disc Rongeurs**

6.25° Straight

 F11-175 2 x 12mm  
 F11-176 3 x 12mm  
 F11-177 4 x 14mm  
 F11-178 5 x 14mm  
 F11-179 6 x 16mm

6.25° Up

 F11-180 3 x 12mm  
 F11-181 4 x 14mm  
 F11-182 5 x 14mm

6.25° Down

 F11-183 3 x 12mm  
 F11-184 4 x 14mm

**Caspar Type Intervertebral Disc Rongeurs**

7.25° Straight

 F11-185 2 x 12mm  
 F11-186 3 x 12mm  
 F11-187 4 x 14mm  
 F11-188 5 x 14mm  
 F11-189 6 x 16mm

7.25° Up

 F11-190 2 x 12mm  
 F11-191 3 x 12mm  
 F11-192 4 x 14mm  
 F11-193 5 x 14mm

7.25° Down

 F11-194 2 x 12mm  
 F11-195 3 x 12mm  
 F11-196 4 x 14mm

**Cushing Intervertebral Disc Rongeurs**

7° Straight

 F11-197 Straight  
 F11-198 Up  
 F11-199 Down

**L-G Intervertebral Disc Rongeurs**

7° Straight

 F11-200 Straight  
 F11-201 Up  
 F11-202 Down

3 x 10mm 10°

F11-203 Straight

	Fig. 1 3.0mm F11-204	Fig. 2 3.5mm F11-205	Fig. 2 4.5mm F11-206	Fig. 4 5.0mm F11-207	Fig. 5 5.5mm F11-208
0° 12cm 4 3/4" Straight	F11-209	F11-210	F11-211	F11-212	F11-213
45° 12cm 4 3/4" 45° up	F11-214	F11-215	F11-216		
90° 12cm 4 3/4" 90° up					
45° 16cm 7" 45° up	Fig. 1 3.0mm F11-217	Fig. 2 3.5mm F11-218	Fig. 2 4.5mm F11-219	Fig. 4 5.0mm F11-220	Fig. 5 5.5mm F11-221
90° 16cm 7" 90° up	F11-222	F11-223	F11-224	F11-225	

**Well Blakesley Laminectomy rongeurs**

**Spurling Intervertebral  
Disc Rongeurs**  
w/teeth 4 x 10mm, 7"  
F11-226 Straight  
F11-227 Up  
F11-228 Down

4 x 10mm, 10"  
F11-229 Straight

5 x 10mm, 10"  
F11-230 Straight



**Schlesinger Intervertebral  
Disc Rongeurs**

F11-231 2 x 10mm 5" Straight  
F11-232 3 x 10mm 5" Straight  
F11-233 4 x 10mm 5" Straight  
F11-234 3 x 10mm 5" Angled Up



**Cloward Intervertebral  
Disc Rongeurs**  
serrated 6 x 10mm, 5"  
F11-235 Straight  
F11-236 Up  
F11-237 Down



**Oldberg Intervertebral  
Disc Rongeurs**  
F11-236 6mm Diameter  
7-1/8"



**Selverstone Intervertebral  
Disc Rongeurs**  
F11-239 2 x 3mm, 6"  
F11-240 2 x 5mm, 6"





**Cushing intervertebral  
Disc Rongeurs**  
2 X 10mm, 5"  
F11-241 Straight  
F11-242 Up  
F11-243 Down



**Fespod Intervertebral  
Disc Rongeurs, 5-1/2"**  
F11-250 Angle up 1.5mm, x-small  
F11-251 Angle up 2mm, small  
F11-252 Angle up 2.5mm, medium  
F11-253 Angle up 3mm, large



**Peapod Intervertebral  
Disc Rongeurs,**  
F11-254 Angle up 2.5mm, 7"  
F11-255 Angle up 3mm, 7"  
F11-256 Angle up 4mm, 7"  
F11-257 Straight 2mm 5-1/2"  
F11-258 Straight 2.5mm, 5-1/2"  
F11-259 Straight 3mm 5-1/2"

**Love-Gruenwald Intervertebral  
Disc Rongeurs**  
3 X 10mm, 5"  
F11-244 Straight  
F11-245 Up  
F11-246 Down

**Spurling Intervertebral  
Disc Rongeurs**  
4 X 10mm, 5"  
F11-247 Straight  
F11-248 Up  
F11-249 Down



**Decker Intervertebral  
Disc Rongeurs**  
2 x 5mm, 6"  
F11-260 Right  
F11-261 Left  
F11-262 Down  
F11-263 Up  
F11-264 Straight

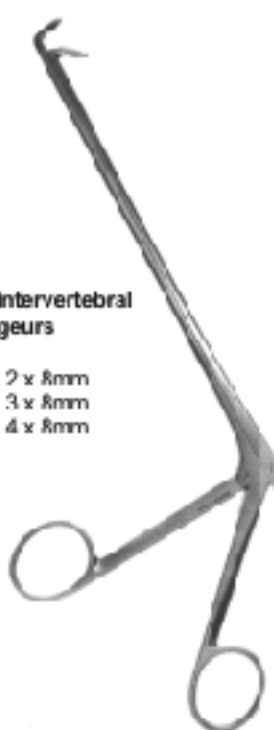

**Jackson Intervertebral  
Disc Rongeurs**  
70° Lp 7"  
F11-265 2 x 8mm  
F11-266 3 x 8mm  
F11-267 4 x 8mm



**Williams Style Micro Disc  
Intervertebral Disc Rongeurs**  
1 x 2 teeth, Straight  
F11-268 5.5"  
F11-269 7"  
F11-270 10"

**Ferris Smith Micro Kerrison  
Laminectomy Rongeurs**

90° UP 9mm bite opening, 7"

- F11-271 1mm
- F11-272 2mm
- F11-273 3mm
- F11-274 4mm
- F11-275 5mm
- F11-276 6mm



90° LIP 9mm bite opening, 8"

- F11-277 1mm
- F11-278 2mm
- F11-279 3mm
- F11-280 4mm
- F11-281 5mm
- F11-282 6mm

**Ferris Smith Micro Kerrison  
Laminectomy Rongeurs**

90° Down 9mm bite opening, 7"

- F11-283 1mm
- F11-284 2mm
- F11-285 3mm
- F11-286 4mm
- F11-287 5mm
- F11-288 6mm



90° Down 9mm bite opening, 8"

- F11-289 1mm
- F11-290 2mm
- F11-291 3mm
- F11-292 4mm
- F11-293 5mm
- F11-294 6mm

**Micro Ejector Kerrison  
Laminectomy Rongeurs**

40° Up 8"

- F11-295 2mm
- F11-296 3mm
- F11-297 4mm
- F11-298 5mm
- F11-299 6mm



**Wide Mouth Ejector Kerrison  
Laminectomy Rongeurs**

40° Up 7"

- F11-300 2mm
- F11-301 3mm
- F11-302 4mm
- F11-303 5mm
- F11-304 6mm

40° Up 8"

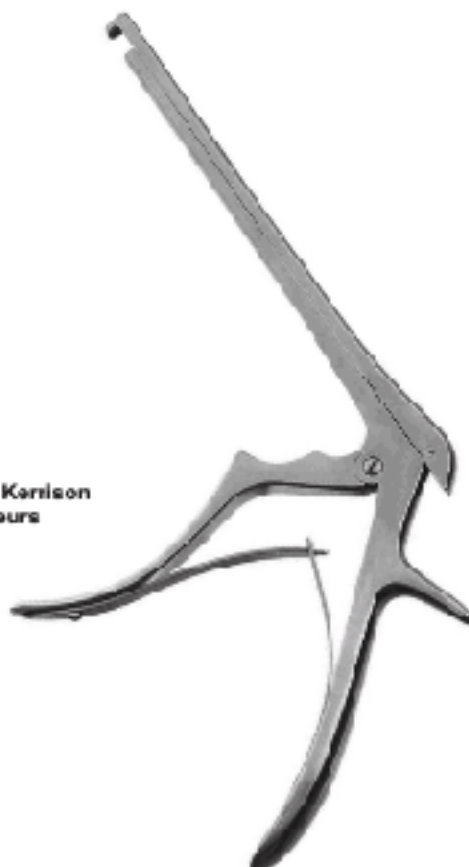
- F11-305 2mm
- F11-306 3mm
- F11-307 4mm
- F11-308 5mm
- F11-309 6mm



**Ferris-Smith Intervertebral  
Disc Rongeurs**

7" sl. shft.

F11-310	2 x 10mm
F11-311	3 x 10mm
F11-312	4 x 8mm
F11-313	4 x 10mm
F11-314	6 x 10mm
F11-315	6 x 12mm

**Ferris-Smith Intervertebral  
Disc Rongeurs**

7" Jp

F11-316	2 x 10mm
F11-317	3 x 10mm
F11-318	4 x 10mm
F11-319	6 x 10mm

7" Down

F11-320	2 x 10mm
F11-321	3 x 10mm
F11-322	4 x 10mm
F11-323	6 x 10mm

**Ferris Smith Micro Kerrison  
Lamirectomy Rongeurs**

130° Down Bite, 11" 130° Down Bite, 12"

F11-324	4mm	F11-327	1mm
F11-325	5mm	F11-328	2mm
F11-326	6mm	F11-329	3mm
		F11-330	4mm
		F11-331	5mm
		F11-332	6mm

**Kerrison Cervical Rongeur  
F11-333**

 17.8 cm 7" shaft, 3 mm  
40 degree forward angle

**Schliesinger Cervical Rongeur  
F11-334**

 twin tips, 6" (15.2 cm) shaft,  
up-bite, 3 mm



**Ferris Smith Micro Kerrison  
Laminectomy Rongeurs  
Upward**



**Ferris Smith Micro Kerrison  
Laminectomy Rongeurs  
Downward**

**40° UP**

9mm bite opening, 7"

**F11-335**
**F11-336** 1mm

**F11-337** 2mm

**F11-338** 3mm

**F11-339** 4mm

**F11-340** 5mm

**F11-341** 6mm

**40° Down**

9mm bite opening, 7"

**F11-342** 2mm

**F11-343** 3mm

**F11-344** 4mm

**F11-345** 5mm

**F11-346** 6mm

**40° UP**

9mm bite opening, 8"

**F11-347** 1mm

**F11-349** 2mm

**F11-350** 3mm

**F11-351** 4mm

**F11-352** 5mm

**F11-353** 6mm

**40° Down**

9mm bite opening, 8"

**F11-354** 1mm

**F11-355** 2mm

**F11-356** 3mm

**F11-357** 4mm

**F11-358** 5mm

**F11-359** 6mm

**40° UP**

9mm bite opening, 9"

**F11-360** 1mm

**F11-361** 2mm

**F11-362** 3mm

**F11-363** 4mm

**F11-364** 5mm

**F11-365** 6mm

**40° UP**

9mm bite opening, 10"

**F11-366** 2mm

**F11-367** 3mm

**F11-368** 4mm

**F11-369** 5mm

**F11-370** 6mm

**40° UP**

9mm bite opening

**F11-371** 2mm

**F11-372** 3mm

**F11-373** 4mm

**F11-374** 5mm

**F11-375** 6mm

**40° UP**

9mm bite opening, 12"

**F11-376** 2mm

**F11-377** 3mm

**F11-378** 4mm

**F11-379** 5mm

**F11-380** 6mm

**130° Down**

9mm bite opening, 7"

**F11-381** 1mm

**F11-382** 2mm

**F11-383** 3mm

**F11-384** 4mm

**F11-385** 5mm

**F11-386** 6mm

**130° Down**

9mm bite opening, 8"

**F11-387** 1mm

**F11-388** 2mm

**F11-389** 3mm

**F11-390** 4mm

**F11-391** 5mm

**F11-392** 6mm

**130° Down**

9mm bite opening, 9"

**F11-393** 1mm

**F11-394** 2mm

**F11-395** 3mm

**F11-396** 4mm

**F11-397** 5mm

**F11-398** 6mm

**130° Down**

9mm bite opening, 10"

**F11-399** 1mm

**F11-400** 2mm

**F11-401** 3mm

**F11-402** 4mm

**F11-403** 5mm

**F11-404** 6mm

**130° Down**

9mm bite opening, 11"

**F11-405** 1mm

**F11-406** 2mm

**F11-407** 3mm

**F11-408** 4mm

**F11-409** 5mm

**F11-410** 6mm

**130° Down**

9mm bite opening, 12"

**F11-411** 1mm

**F11-412** 2mm

**F11-413** 3mm

**F11-414** 4mm

**F11-415** 5mm

**F11-416** 6mm

**Bayonet Micro Kerrison****Laminectomy Rongeurs**

40° Up, 50 mm	90° Up, 150 mm
Working Length 8"	Working Length 8"
F11-417 1mm	F11-423 1mm
F11-418 2mm	F11-424 2mm
F11-419 3mm	F11-425 3mm
F11-420 4mm	F11-426 4mm
F11-421 5mm	F11-427 5mm
F11-422 6mm	F11-428 6mm

**Foramenotomy Kerrison****Laminectomy Rongeurs, Curved**

F11-441	UP, 9mm Bite opening, 8" 2mm
F11-442	UP, 9mm Bite opening, 8" 3mm
F11-443	UP, 9mm Bite opening, 8" 4mm
F11-444	UP, 9mm Bite opening, 8" 5mm
F11-445	UP, 9mm Bite opening, 8" 6mm
F11-446	Left, 9mm Bite opening, 8" 6mm
F11-447	Right, 9mm Bite opening, 8" 6mm

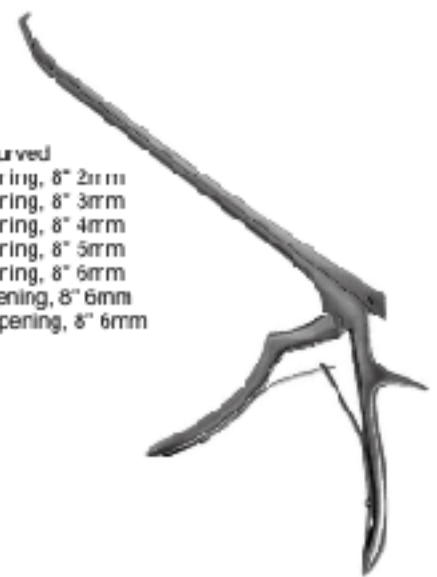
**Bayonet Spurling Kerrison****Laminectomy Rongeurs**

40° Up, 50 mm	90° Up, 150 mm
Working Length 8"	Working Length 8"
F11-429 1mm	F11-435 1mm
F11-430 2mm	F11-436 2mm
F11-431 3mm	F11-437 3mm
F11-432 4mm	F11-438 4mm
F11-433 5mm	F11-439 5mm
F11-434 6mm	F11-440 6mm

40° UP,
15mm Bite Opening, 7"
F11-448 2mm
F11-449 3mm
F11-450 4mm
F11-451 5mm
F11-452 6mm

40° UP,
15mm Bite Opening, 8"
F11-453 2mm
F11-454 3mm
F11-455 4mm
F11-456 5mm
F11-457 6mm

**Spurling Kerrison  
Laminectomy Rongeurs  
Large Handle**

40° UP,
15mm Bite Opening, 9"
F11-458 2mm
F11-459 3mm
F11-460 4mm
F11-461 5mm
F11-462 6mm

40° UP,	90° UP,	90° Down
15mm Bite Opening, 10"	15mm Bite Opening, 7"	15mm Bite Opening, 7"
F11-463 2mm	F11-473 2mm	F11-483 2mm
F11-464 3mm	F11-474 3mm	F11-484 3mm
F11-465 4mm	F11-475 4mm	F11-485 4mm
F11-466 5mm	F11-476 5mm	F11-486 5mm
F11-467 6mm	F11-477 6mm	F11-487 6mm

40° UP,	90° UP,	90° Down
15mm Bite Opening, 11"	15mm Bite Opening, 8"	15mm Bite Opening, 8"
F11-468 2mm	F11-478 2mm	F11-488 2mm
F11-469 3mm	F11-479 3mm	F11-489 3mm
F11-470 4mm	F11-480 4mm	F11-490 4mm
F11-471 5mm	F11-481 5mm	F11-491 5mm
F11-472 6mm	F11-482 6mm	F11-492 6mm

**Spurling Laminectomy  
Rongeurs**

40° UP, 15mm	40° UP, 15mm
Bite Opening, 7"	Bite Opening, 9"
F11-493 2mm	F11-503 2mm
F11-494 3mm	F11-504 3mm
F11-495 4mm	F11-505 4mm
F11-496 5mm	F11-506 5mm
F11-497 6mm	F11-507 6mm

40° UP, 15mm	40° UP, 15mm
Bite Opening, 8"	Bite Opening, 10"
F11-498 2mm	F11-508 2mm
F11-499 3mm	F11-509 3mm
F11-500 4mm	F11-510 4mm
F11-501 5mm	F11-511 5mm
F11-502 6mm	F11-512 6mm

40° UP, 15mm
Bite Opening, 11"
F11-513 2mm
F11-514 3mm
F11-515 4mm
F11-516 5mm
F11-517 6mm

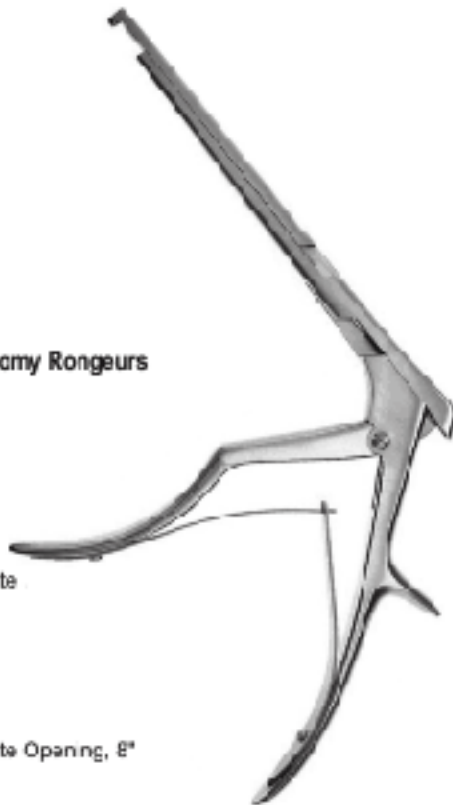
**Spurling Laminectomy Rongeurs**

90° Down, 15mm Bite

- F11-518 2mm
- F11-519 3mm
- F11-520 4mm
- F11-521 5mm
- F11-522 6mm

90° Down, 15mm Bite Opening, 8°

- F11-523 2mm
- F11-524 3mm
- F11-525 4mm
- F11-526 5mm
- F11-527 6mm

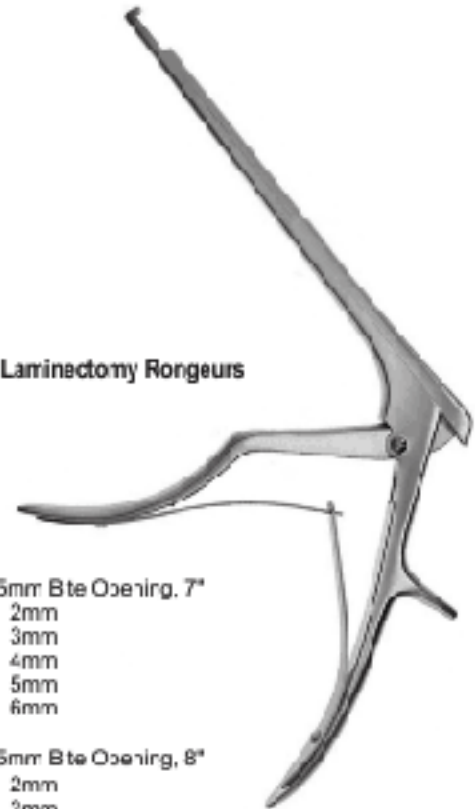
**Spurling Laminectomy Rongeurs**

90° UP, 15mm Bite Opening, 7°

- F11-528 2mm
- F11-529 3mm
- F11-530 4mm
- F11-531 5mm
- F11-532 6mm

90° UP, 15mm Bite Opening, 8°

- F11-533 2mm
- F11-534 3mm
- F11-535 4mm
- F11-536 5mm
- F11-537 6mm

**Micro Ejector Kerrison  
Laminectomy Rongeurs**

40° Up 8°

- F11-538 2mm
- F11-539 3mm
- F11-540 4mm
- F11-541 5mm
- F11-542 6mm

**Wide Mouth Ejector Kerrison  
Laminectomy Rongeurs**

40° Up 7°

- F11-543 2mm
- F11-544 3mm
- F11-545 4mm
- F11-546 5mm
- F11-547 6mm

40° Up 8°

- F11-548 2mm
- F11-549 3mm
- F11-550 4mm
- F11-551 5mm
- F11-552 6mm





**Cloward Retractor**  
F11-553  
15.5 cm, 5"



**Cloward Retractor**  
F11-554  
13.5 cm, 5 1/4"



**Cloward Vertebral Cervical Spreader**  
F11-555



**Spinal Distractor**  
F11-556 24cm 9 1/2"  
45° angle / small style  
1/4" rods



**Inge Retractor**  
F11-557  
17.0 cm, 3 3/4"

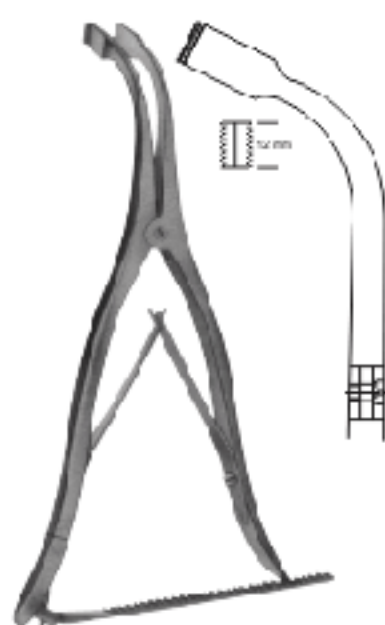

**Inge Retractor**  
F11-558  
27.5 cm, 10 3/4"



**Spinal Distractor**  
F11-558 26.5cm 10"  
small style



**Inge Retractor**  
F11-560 20cm 8"  
toothed w/spindle



# INTESTINAL AND RECTAL INSTRUMENTS







**Allis Tissue Forceps**  
**F12-001**  
 3 x 4 teeth  
 15.5 cm, 6"

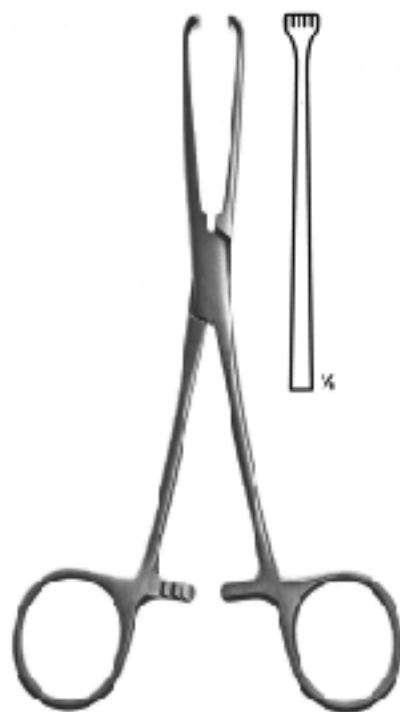

**Allis Tissue Forceps**  
**F12-002**  
 4 x 5 teeth  
 15.5 cm, 6"



**Allis Tissue Forceps**  
**F12-003** 19.0 cm, 7 1/2"  
**F12-004** 25.5 cm, 10"  
 5 x 6 teeth



**Baby Allis Tissue Forceps**  
**F12-005**  
 14 cm 5 1/2" 4 X 5 teeth  
 delicate jaws 4 mm wide



**Judd-Allis Tissue Forceps**  
**F12-006**  
 3 x 4 teeth  
 19.5 cm, 7 3/4"



**Williams Grasp Forceps**  
**F12-007**  
 16 cm, 6 1/2"



**Chaput Tissue Forceps**  
**F12-003**  
 2 x 3 teeth, sharp  
 12.6 cm, 5"

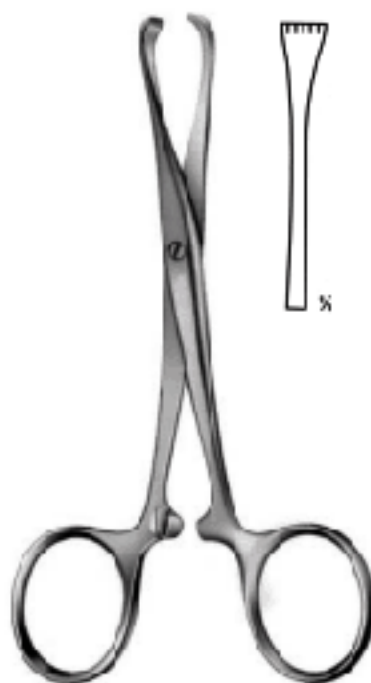

**Tuffier Tissue Forceps**  
**F12-009**  
 5 x 6 teeth, sharp  
 12.6 cm, 5"



**Roy's-Alia Tissue Forceps**  
**F12-010**  
 5 x 6 teeth, sharp  
 15.5 cm, 6"

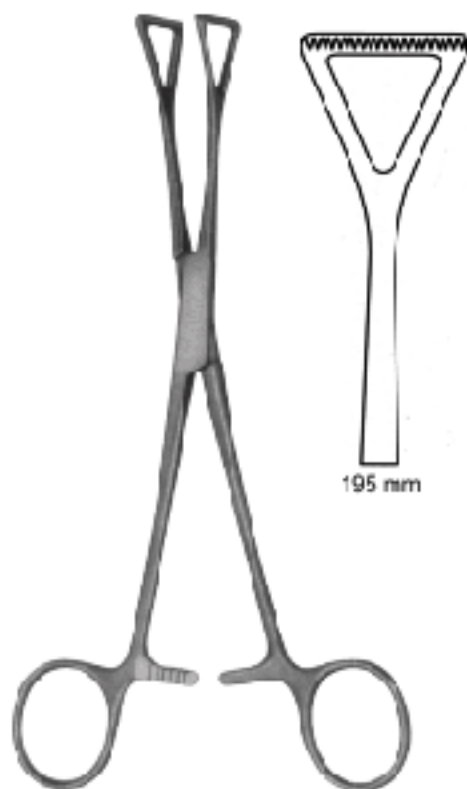

**Duval-Collin Grasp Forceps**  
**F12-011** 19.5 cm, 7 3/4"  
**F12-012** 20.0 cm, 8"

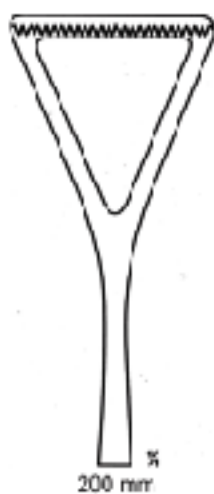

200 mm

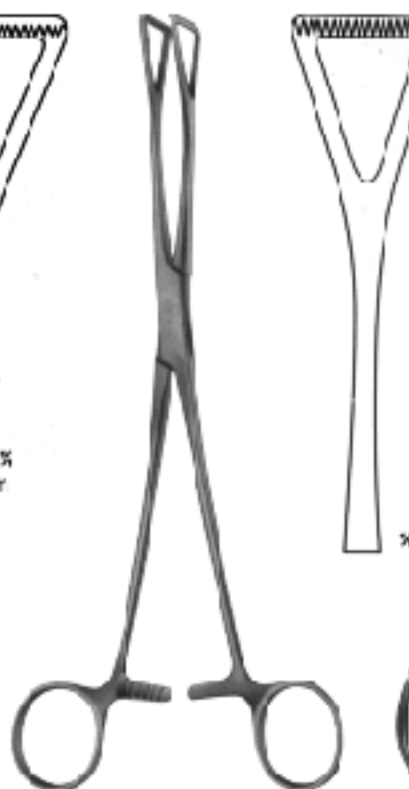

**Duval Grasp Forceps**  
**F12-013**  
 23.0 cm, 9"

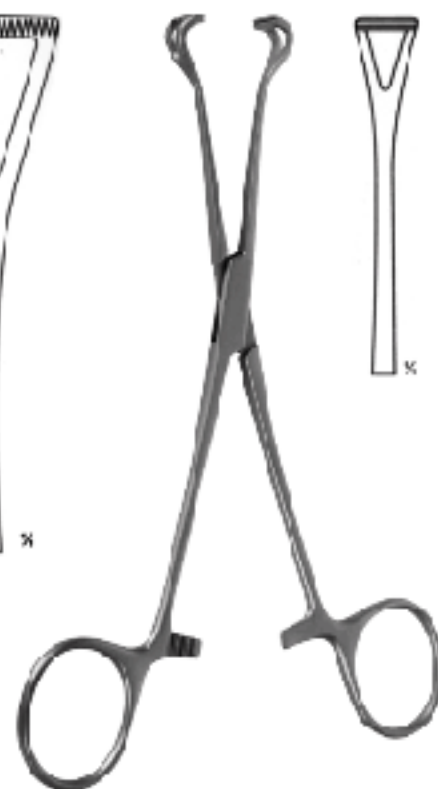

**Bebcock Seizing Forceps**  
**F12-014**  
 15.5 cm, 6"

**Babcock Seizing Forceps**

**F12-015**  
17.0 cm, 6 3/4"

**F12-016**  
21.5 cm, 8 1/2"

**Babcock Seizing Forceps**  
**F12-017**  
22.0 cm, 9 1/4"

**Babcock Tissue Grasping Forceps**  
**F12-018** 18 cm, 7"  
**F12-019** 24 cm, 9 1/2"

**Babcock Tissue Grasping Forceps**

**F12-020**  
16.0 cm, 6 1/4"

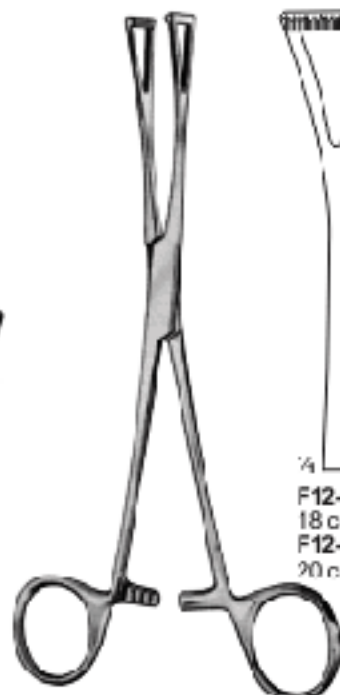
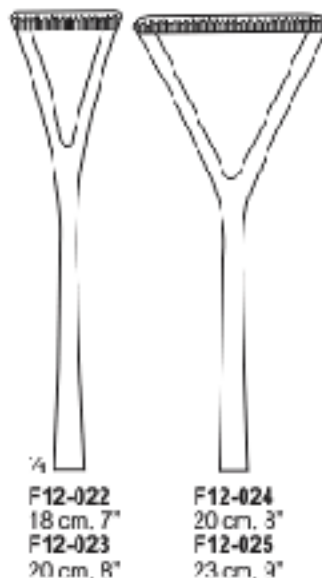
**F12-021**  
21.5 cm, 8 1/4"

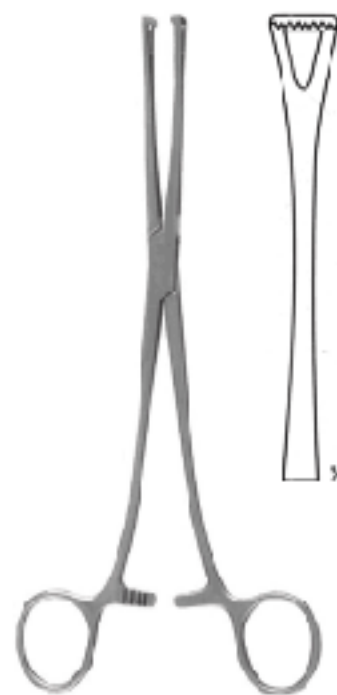
**Duval Tissue Grasping Forceps**

**F12-022**  
18 cm, 7"  
**F12-023**  
20 cm, 8"

**F12-024**  
20 cm, 8"  
**F12-025**  
23 cm, 9"

**Lockwood Grasp Forceps**  
**F12-026**  
20.0 cm, 8"



**Little Wood Tissue Grasping Forceps**  
**F12-027** 19 cm, 7 1/2"  
 Box Joint



**Lana Tissue Grasping Forceps**  
**F12-028** 17.7 cm, 5"  
**F12-029** 15 cm, 6"  
**F12-030** 19 cm, 7 1/2"



**F12-031**  
 25 cm, 10"



**F12-032**  
 27 cm, 10 3/4"

**Duval Intestinal and Tissue Grasping Clamp Forceps**



**Rabcock Intestinal & Tissue Grasping Clamp Forceps T.C**



**T.C-F12-033**  
 16.5 cm, 6 1/2"



**T.C-F12-034**  
 20.3 cm, 8"



**T.C-F12-035**  
 17.5 cm, 7"



**T.C-F12-036**  
 19.5 cm, 8"



**Duval Intestinal & Tissue Grasping Clamp Forceps T.C**



**T.C-F12-037**  
 13 cm, 5 1/4"



**T.C-F12-038**  
 18 cm, 7"

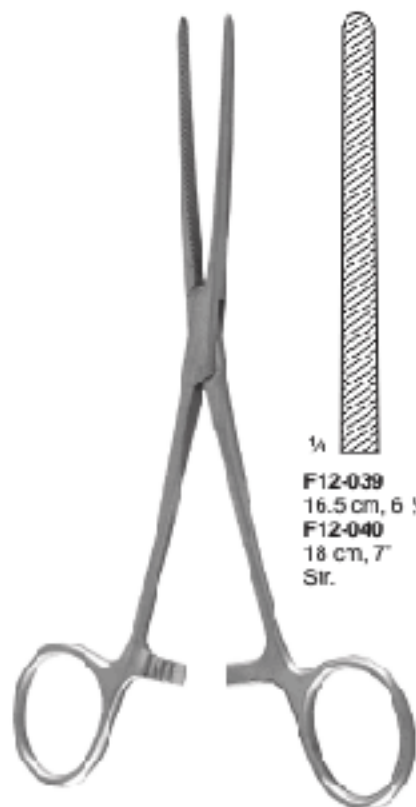

1/4  
**F12-039**  
 16.5 cm, 6 1/2"  
**F12-040**  
 18 cm, 7"  
 Str.

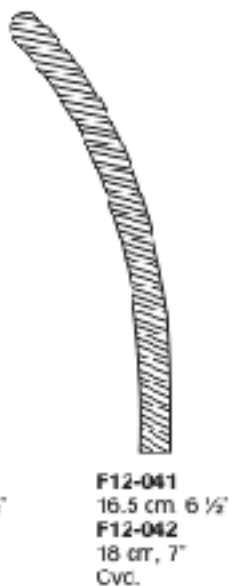

**F12-041**  
 16.5 cm 6 1/2"  
**F12-042**  
 18 cm, 7"  
 Cvd.



3/4  
**F12-043**  
 21 cm, 8 1/4"  
**F12-044**  
 23 cm, 9"  
**F12-045**  
 25 cm, 10"  
 Str.

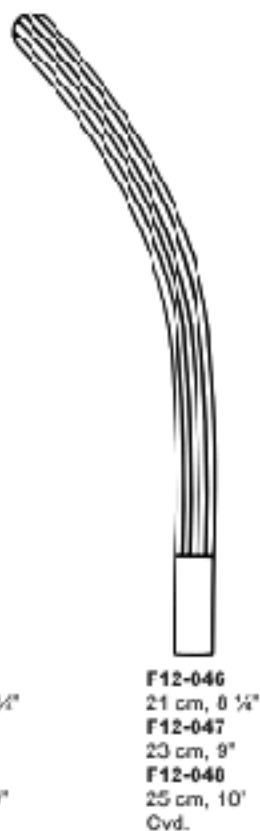

**F12-046**  
 21 cm, 8 1/4"  
**F12-047**  
 23 cm, 9"  
**F12-048**  
 25 cm, 10"  
 Cvd.

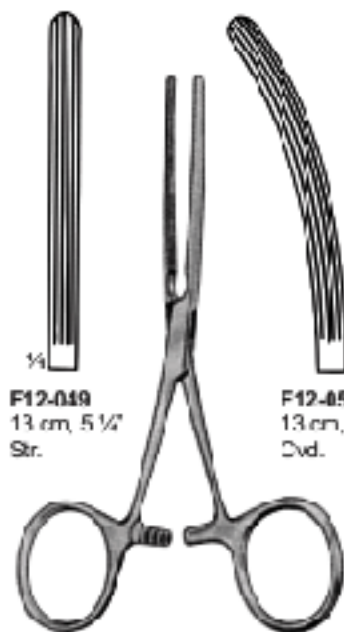

1/4  
**F12-049**  
 13 cm, 5 1/4"  
 Str.

**F12-050**  
 13 cm, 5 1/4"  
 Cvd.



1/4  
**F12-051**  
 22 cm, 8 3/4"  
 Straight



3/4  
**F12-052**  
 21 cm, 8 1/4"  
**F12-053**  
 23 cm, 9"  
 straight,  
 grooved

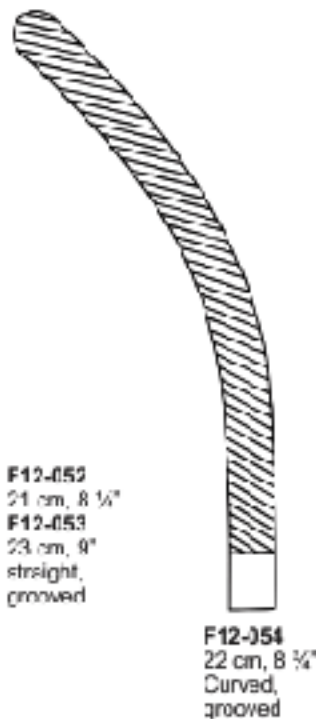

**F12-054**  
 22 cm, 8 3/4"  
 Curved,  
 grooved

**Baby-Kocher Intestinal Forceps Clamps**

**Kocher Intestinal Forceps Clamps**

**Doyen Intestinal Forceps Clamps**



## POLYOUS GRASPING FORCEPS, ANASTOMOSIS

Polypenfasszange, Darm-anastomosenklemmen

Pinça Para Coger Pólipos, Clamps Para Anastomosis Intestinaldes

Pince Pour Saisir Polypes, Pinces-clamps Pour Anastomose Intestinale

Pinze Per Afferrare Polip; Pinze Per Anastomosi Intestinali

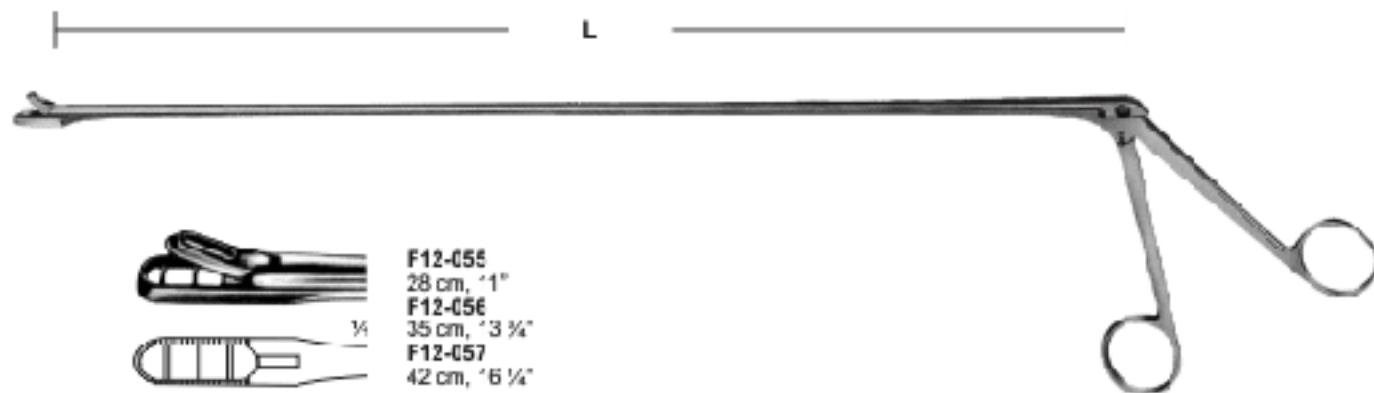

Yeomann Intestinal  
Polyous Grasping  
Forceps

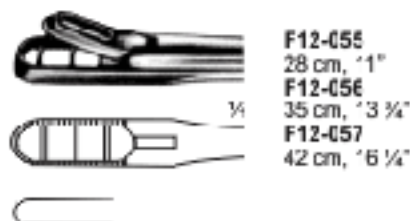

**F12-055**

28 cm, "1"

**F12-056**

35 cm, "3 1/4"

**F12-057**

42 cm, "6 1/4"

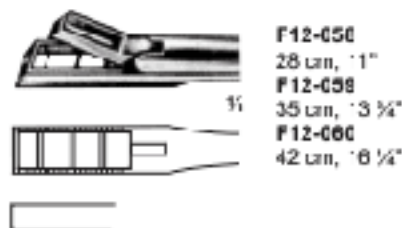

**F12-058**

28 cm, "1"

**F12-059**

35 cm, "3 1/4"

**F12-060**

42 cm, "6 1/4"

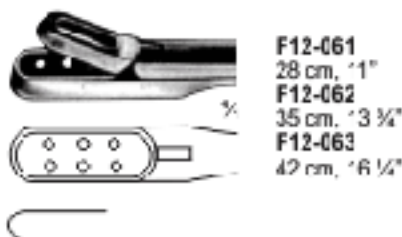

**F12-061**

28 cm, "1"

**F12-062**

35 cm, "3 1/4"

**F12-063**

42 cm, "6 1/4"

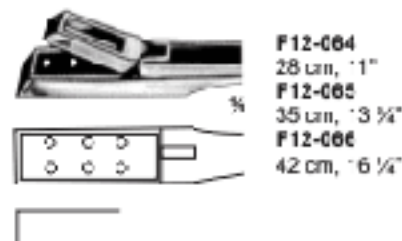

**F12-064**

28 cm, "1"

**F12-065**

35 cm, "3 1/4"

**F12-066**

42 cm, "6 1/4"



**Payr-Eaby Crushing Intestinal Clamp**  
**F12-067**  
 15 cm, 6"  
 without pin  
**F12-068**  
 15 cm, 6"  
 with pin

**Payr Crushing Intestinal Clamp**  
**F12-069**  
 21 cm, 8 1/2"  
 without pin  
**F12-070**  
 21 cm, 8 1/2"  
 with pin

**Payr Crushing Intestinal Clamp**  
**F12-071**  
 29 cm, 11 1/2"  
 without pin  
**F12-072**  
 29 cm, 11 1/2"  
 with pin

**Payr Crushing Intestinal Clamp**  
**F12-073**  
 35 cm, 13 3/4"  
 without pin  
**F12-074**  
 35 cm, 13 3/4"  
 with pin



**Lane Stomach Intestinal  
Clamp Forceps**  
F12-075  
30 cm 12" Str.

**Lane Stomach Intestinal  
Clamp Forceps**  
F12-076  
30 cm 12" Cvd.





**Mathieu Rectal Speculum**  
**F12-077** 19.5 cm, 7 3/8"  
 90 x 15 mm



**Sims Rectal Speculum**  
**F12-078** 15 cm, 6"



**Sims Rectal Speculum**  
**F12-079** 15 cm, 6"



**Barr Rectal Speculum**  
**F12-080** 80mm  
 Blade size



**Ives-Farsler Rectal Speculum**  
**F12-031** 14.5 mm, 5 3/8"  
 22 mm Ø



**Pratt Rectal Speculum**  
**F12-082** 21.5 cm, 8 1/2"  
 85 x 25 mm blade



**Czarny Rectal Speculum**  
**F12-083**  
 22 cm, 8 3/4"



**Hirschmann Intestinal  
Rectal Speculum**  
F12-084  
23 mm Ø  
proctoscope  
working length: 145 mm



F12-085  
22 Ø x 50 mm  
F12-086  
22 Ø x 100 mm  
F12-087  
22 Ø x 140 mm  
F12-088  
22 Ø x 200 mm

**Kelly Intestinal  
Rectal Speculum**



F12-089  
19 Ø x 70 mm  
F12-090  
22 Ø x 70 mm

**Bensaude Intestinal  
Rectal Speculum**

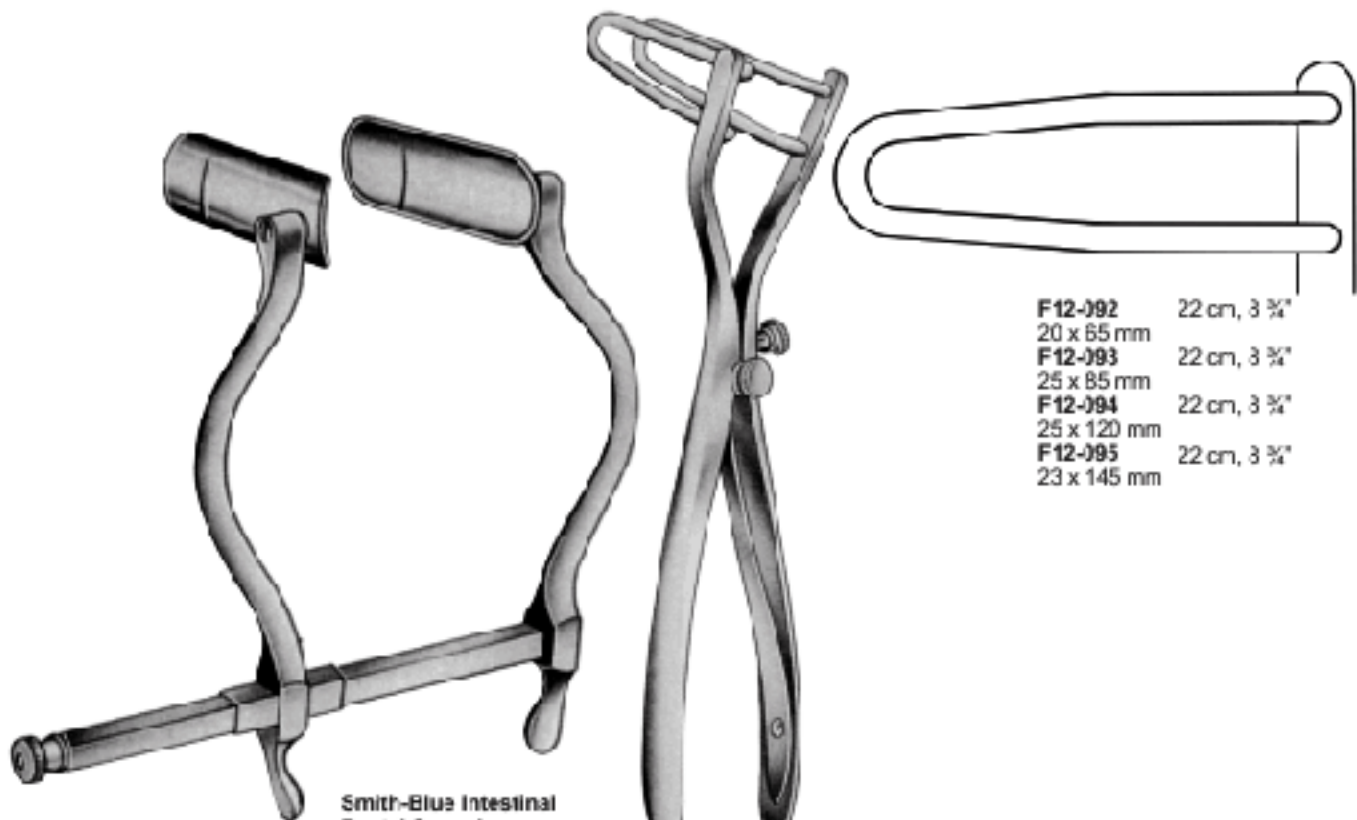

**Smith-Blue Intestinal  
Rectal Speculum**  
F12-091 15 cm, 6"  
75 x 23 mm

**Schulze-Dergmann Intestinal  
Rectal Speculum**

F12-092 22 cm, 3 3/4"  
20 x 65 mm  
F12-093 22 cm, 3 3/4"  
25 x 85 mm  
F12-094 22 cm, 3 3/4"  
25 x 120 mm  
F12-095 22 cm, 3 3/4"  
23 x 145 mm



**Barr-Shifford Intestinal Rectal Speculum**  
F12-096

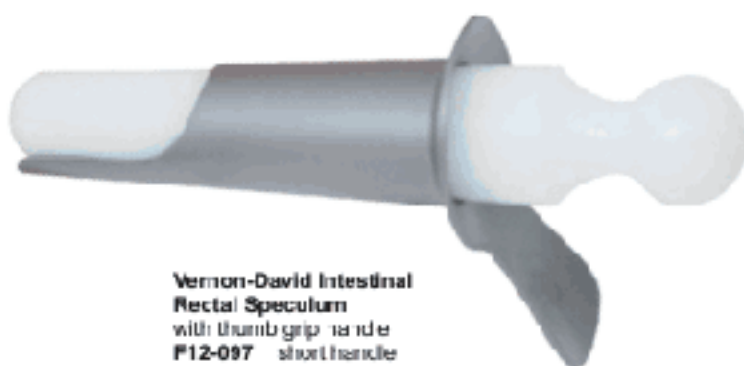

**Vernon-David Intestinal Rectal Speculum**  
with thumb grip handle  
F12-097 short handle  
F12-098 long (standard) handle



**Fensler Operating Intestinal Rectal Speculum**  
with slotted / extra long handle  
F12-101 standard  
F12-102 25 mm x 65 mm (1" x 2 1/2")  
F12-103 29 mm x 65 mm (1 1/4" x 2 1/2")  
F12-104 38 mm x 70 mm (1 1/2" x 2 3/4")  
  
with slotted tube / short handle  
F12-105 29 mm x 60 mm (1 1/4" x 2 1/4")  
F12-106 operating speculum



**Chelsea-Faton Intestinal Rectal Speculum**  
split handle  
F12-099 small  
F12-100 large  
with light: connection available



**Brinkerhoff Intestinal Rectal Speculum**  
F12-107 small 3 1/2" x 1" tapers to 1/2"  
F12-108 medium 4" x 1" tapers to 5/8"  
F12-109 large 4 3/4" x 1 1/4" tapers to 3/4"



## INTESTINAL RECTAL SPECULA

Mastdarmspekula | Spéculum's Rectaux  
Espéculas Rectales | Specoli Rettali



**Ives-fansler Anoscope**  
Intestinal Rectal Speculum  
with hard rubber obturator /  
fenestrated handle  
F12-110 22 mm x 05 mm



**Long Chrome Handle**  
Intestinal Rectal Speculum  
F12-111 3 1/4" x 1 1/8"

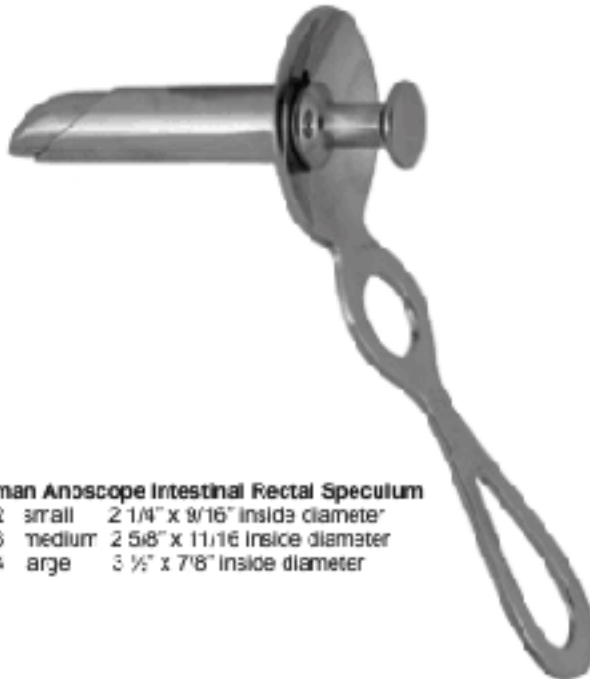

**Hirschman Anoscope Intestinal Rectal Speculum**  
F12-112 small 2 1/4" x 9/16" inside diameter  
F12-113 medium 2 5/8" x 11/16" inside diameter  
F12-114 large 3 1/2" x 7/8" inside diameter



**Bule Hirschman Anoscope Intestinal**  
Rectal Speculum  
F12-115 small 2 1/4" x 9/16" inside diameter  
F12-116 medium 3 3/4" x 3/4" inside diameter  
F12-117 large 3 7/8" x 15/16" inside diameter



**Morgen Proctoscope**  
Intestinal Rectal Speculum  
with light connection  
F12-118 17mm  
F12-119 20mm  
F12-120 24mm

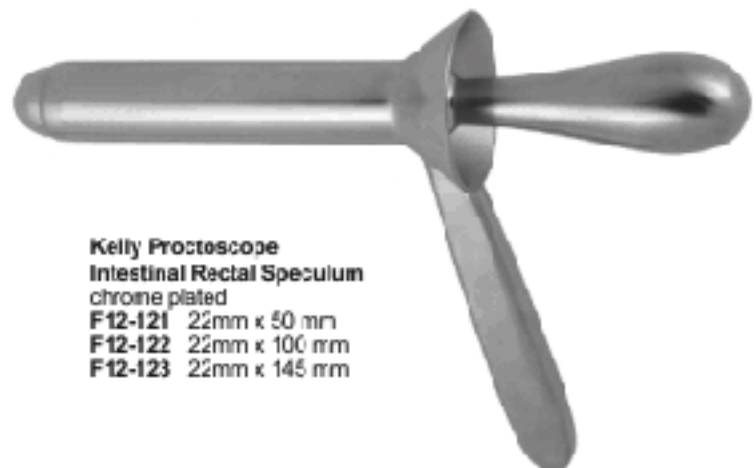

**Kelly Proctoscope**  
Intestinal Rectal Speculum  
chrome plated  
F12-121 22mm x 50 mm  
F12-122 22mm x 100 mm  
F12-123 22mm x 145 mm



**GYNECOLOGY / OBSTETRICS**

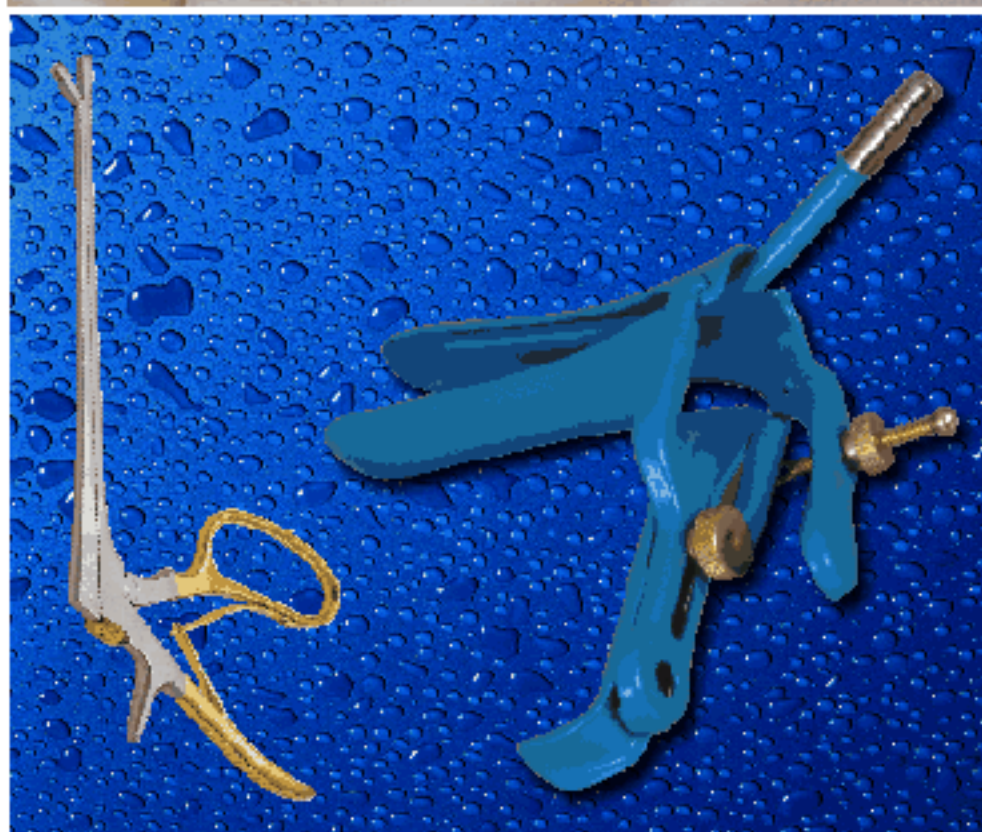



**Cusco vaginal speculum**  
**F13-001** 75 mm x 32 mm  
**F13-002** 85 mm x 35 mm  
**F13-003** 100 mm x 35 mm  
**F13-004** 75 mm x 17 mm  
 for virgins



**Cusco vaginal speculum**  
**F13-005** 75 mm x 32 mm  
**F13-006** 30 mm x 35 mm  
**F13-007** 100 mm x 37 mm



**Cusco vaginal speculum**  
**F13-008** 80 mm x 22 mm  
**F13-009** 100 mm x 25 mm  
**F13-010** 105 mm x 27 mm  
 Swiss pattern



**Grave vaginal speculum**  
**F13-011** 75 mm x 20 mm  
**F13-012** 95 mm x 35 mm  
**F13-013** 115 mm x 35 mm



**Collin vaginal speculum**  
**F13-014** 85 mm x 30 mm  
**F13-015** 100 mm x 35 mm  
**F13-016** 110 mm x 40 mm



**Semm vaginal speculum**  
**F13-017** 90 mm x 14 / 18 mm  
**F13-018** 100 mm x 7 / 20 mm  
**F13-019** 110 mm x 25 / 30 mm



## VAGINAL SPECULUM

<i>Scheidenspectula</i>	<i>Especulos vaginales</i>
<i>Spéculum vaginaux</i>	<i>Specoli vaginali</i>



**Graves Vaginal Speculum**  
**F13-020** Small 2.2 cm 7/8" Blade  
**F13-021** Medium 3.5 cm 1 3/8" Blade  
**F13-022** Large 3.7 cm 1 1/2" Blade



**Trelat vaginal speculum**  
**F13-023** 35 mm x 30 mm  
**F13-024** 35 mm x 35 mm  
**F13-025** 115 mm x 43 mm



**Pederson vaginal speculum**  
**F13-026** 75 mm x 13 mm  
**F13-027** 100 mm x 22 mm  
**F13-028** 120 mm x 25 mm



**Graves Vaginal Speculum Leep / Lietz**  
**F13-029** Small  
**F13-030** Medium  
**F13-031** Large  
**F13-032** X-large



**Pederson Vaginal Speculum Leep / Lietz**  
**F13-033** Small  
**F13-034** Medium  
**F13-035** Large  
**F13-036** X-large



**Kristeller Speculum & Retractor**  
**F13-037** 70 mm x 27 mm  
**F13-038** 80 mm x 30 mm  
**F13-039** 90 mm x 36 mm  
**F13-040** 110 mm x 27 mm  
**F13-041** 110 mm x 30 mm  
**F13-042** 110 mm x 36 mm



**Kristeller Speculum & Retractor**  
**F13-043** 75 mm x 23 mm  
**F13-044** 85 mm x 26 mm  
**F13-045** 100 mm x 32 mm  
**F13-046** 115 mm x 23 mm  
**F13-047** 115 mm x 26 mm  
**F13-048** 115 mm x 32 mm

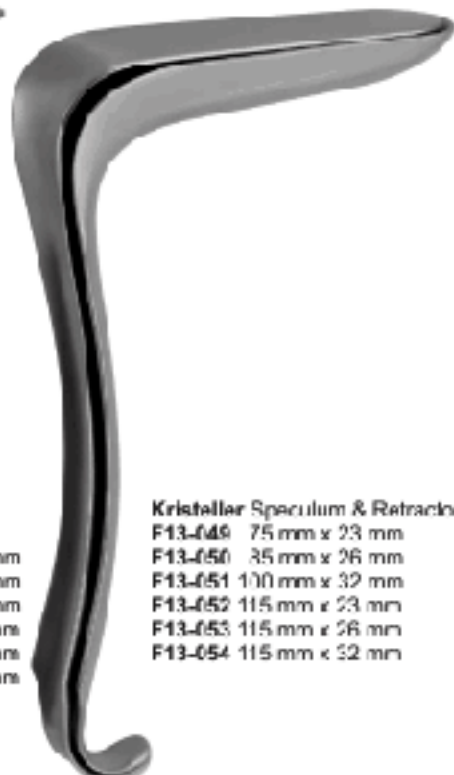

**Kristeller Speculum & Retractor**  
**F13-049** 75 mm x 23 mm  
**F13-050** 85 mm x 26 mm  
**F13-051** 100 mm x 32 mm  
**F13-052** 115 mm x 23 mm  
**F13-053** 115 mm x 26 mm  
**F13-054** 115 mm x 32 mm



**Kristeller speculum & retractor**  
**F13-055** 105 mm x 18 mm  
**F13-056** 105 mm x 21 mm  
 Speculum tapered, for virgins



**Kristeller Speculum & Retractor**  
**F13-057** 110 mm x 14 mm  
**F13-058** 115 mm x 17 mm



**Kristeller Speculum & Retractor**  
**F13-059** 110 mm x 14 mm  
**F13-060** 115 mm x 17 mm





**Jackson Speculum & Retractor**  
**F13-061** 75 mm x 35 mm  
**F13-062** 75 mm x 40 mm  
**F13-063** 90 mm x 35 mm  
**F13-064** 90 mm x 40 mm  
**F13-065** 100 mm x 35 mm  
**F13-066** 100 mm x 40 mm



**Sims Speculum & Retractor**  
**F13-067** 83 mm x 25 mm / 30 mm  
**F13-068** 73 mm x 30 mm / 35 mm  
**F13-069** 83 mm x 35 mm / 40 mm



**Kallmorgen Speculum & Retractor**  
**F13-070** 70 mm x 40 mm  
**F13-071** 90 mm x 40 mm



**Kallmorgen Speculum & Retractor**  
**F13-072** 70 mm x 33 mm  
**F13-073** 90 mm x 33 mm



**Kallmorgen Speculum & Retractor**  
**F13-074** 70 mm x 33 mm  
**F13-075** 90 mm x 33 mm



**AUVARD,**  
speculum & retractor  
**F13-076**  
80 x 35 mm - 28 mm  
1,530 kg  
with fixed weight.  
23 cm, 9"



**AUVARD**  
speculum & retractor  
**F13-077** 75 x 42 mm  
(40 mm)  
**F13-078** 105 x 43 mm  
(40 mm)  
with detachable weight  
23 cm, 9"



**WEISSBARTH**  
speculum & retractor  
**F13-078** 50 x 28 mm  
**F13-080** 55 x 42 mm  
21 cm, 8 1/4"



**Garrigue Weighted Vaginal Speculum**  
**F13-081** 40 cm x 8.0 cm 1 5/8" x 3 1/8"  
Weight 2 lbs



**Henrotin Weighted Vaginal Speculum**  
**F13-082** 38 cm x 9.0 cm 1 1/2" x 3 1/2"  
Weight 3 lbs



**Landau speculum**  
29.0 cm 11 1/2"  
F13-083 100 mm x 28 mm  
F13-084 100 mm x 38 mm



**Breisky speculum**  
30.0 cm 12"  
F13-085 130 mm x 20 mm  
F13-086 130 mm x 25 mm  
F13-087 130 mm x 30 mm  
F13-088 130 mm x 35 mm  
F13-089 130 mm x 40 mm  
Vienna pattern



**Breisky speculum**  
30.0 cm 12"  
F13-090 100 mm x 20 mm  
F13-091 100 mm x 25 mm  
F13-092 100 mm x 30 mm  
F13-093 100 mm x 35 mm  
F13-094 100 mm x 40 mm



**Breisky speculum**  
35.0 cm 13 3/4"  
F13-095 160 mm x 40 mm  
F13-096 180 mm x 40 mm

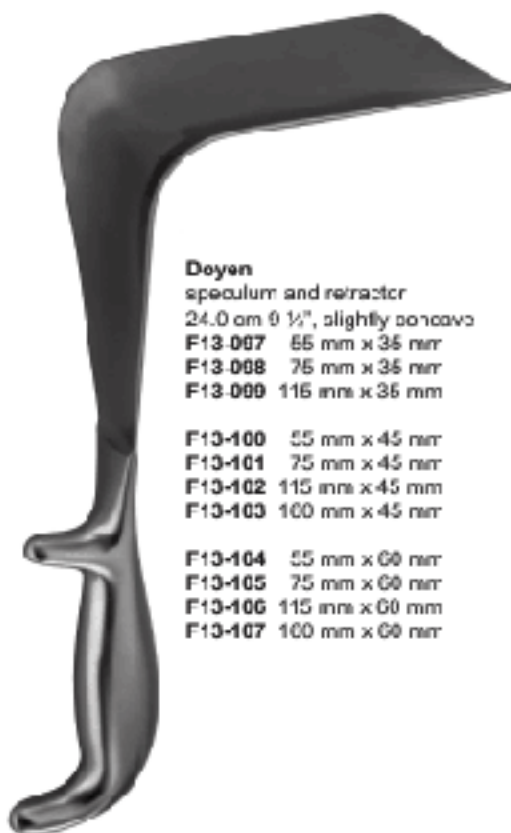

**Doyen**  
speculum and retractor  
24.0 cm 9 1/2", slightly concave  
F13-087 85 mm x 36 mm  
F13-088 75 mm x 36 mm  
F13-089 115 mm x 36 mm  
  
F13-100 55 mm x 45 mm  
F13-101 75 mm x 45 mm  
F13-102 115 mm x 45 mm  
F13-103 100 mm x 45 mm  
  
F13-104 55 mm x 60 mm  
F13-105 75 mm x 60 mm  
F13-106 115 mm x 60 mm  
F13-107 100 mm x 60 mm



**Doyen**  
speculum and retractor  
24.0 cm 9 1/2", medium concave  
F13-108 85 mm x 36 mm  
F13-109 75 mm x 36 mm  
F13-110 115 mm x 36 mm  
  
F13-111 55 mm x 45 mm  
F13-112 75 mm x 45 mm  
F13-113 115 mm x 45 mm  
  
F13-114 55 mm x 60 mm  
F13-115 75 mm x 60 mm  
F13-116 115 mm x 60 mm

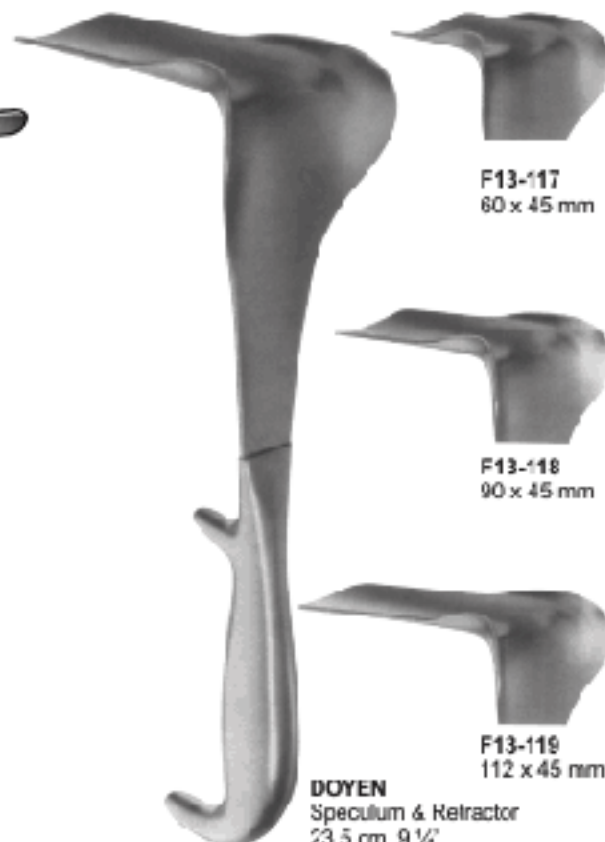

**DOYEN**  
Speculum & Retractor  
23.5 cm, 9 1/2"

F13-117  
60 x 45 mm

F13-118  
90 x 45 mm

F13-119  
112 x 45 mm



**Scherback Speculum  
F13-120**  
Set consisting of:  
handle weight 5 blades



**F13-121**  
80 x 30 mm



**F13-122**  
85 x 35 mm



**F13-123**  
85 x 40 mm



**F13-124**  
55 x 40 - 60 mm



**F13-125**  
70 x 45 - 70 mm



**Scherback Speculum  
F13-125**  
Set consisting of:  
2 handle, 8 blades



**F13-127**  
80 x 30 mm



**F13-131**  
35 x 30 mm



**F13-128**  
85 x 33 mm



**F13-132**  
75 x 35 mm



**F13-129**  
100 x 38 mm



**F13-133**  
85 x 35 mm

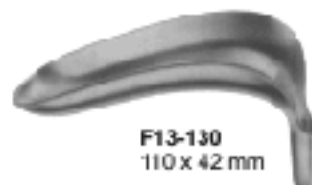

**F13-130**  
110 x 42 mm



**F13-134**  
95 x 35 mm



**O'Sullivan - O'Conner  
Vaginal Retractor  
F13-135 Set of 3 Complete**



**F13-136  
45 x 17 mm**



**F13-137  
90 x 37 mm**



**F13-138  
90 x 46 mm**



**Abdominal Retractor**  
F13-139 8 cm, 3 1/2" wide  
F13-140 10 cm, 4" wide  
F13-141 11.5 cm, 4 1/2" wide



**Friedmann Retractor  
F13-142  
10 cm, 4"**



**Kogan speculum**  
F13-143  
24 cm, 9 1/2"  
with scale-ratchet  
and fixation screw



**Kogan speculum**  
F13-144  
24 cm, 9 1/2"



**Kogan - Modif.**  
speculum  
28 cm, 11"  
F13-145  
x=4 mm y=8mm  
F13-146  
x=2 mm y=4mm



**Lateral Nonconductive**  
Vaginal Retractor  
F13-147 6.3 cm wide



**McGee Lateral**  
Vaginal Retractor  
With Ratchet Handle  
F13-148 20cm, 8"



**Sims Uterine Sound**  
F13-149  
30 cm, 10"  
right, malleable



**Sims Uterine Sound**  
F13-150  
22.5cm 12 3/4"  
Non-graduated



**Sims Uterine Sound**  
F13-151  
22.5cm 12 3/4"  
Graduated in cm



**Sims-Special Uterine Sound**  
F13-152 30 cm, 10"



**Sims Uterine Sound**  
schwed. Modell  
F13-153  
25 cm 10 1/4"



**Martin Uterine Sound**  
F13-154 30 cm, 12"



**Valleix Uterine Sound**  
F13-155 25 cm, 10"



**Mayc Uterine Sound**  
F13-156 33 cm 13"  
biegsam malleable



**Simpson Uterine Sound**  
F13-157 29 cm 11 1/2"  
malleable silver-plated



**Simpson Uterine Sound**  
F13-158 32.5cm 12 3/4"  
Graduated in inches

**Hegar Uterine Dilator**  
single ended

<b>F13-158</b> 1.0mm Ø	<b>F13-179</b> 11.5mm Ø	<b>F13-198</b> 23.0mm Ø
<b>F13-160</b> 1.5mm Ø	<b>F13-180</b> 12.0mm Ø	<b>F13-200</b> 24.0mm Ø
<b>F13-161</b> 2.0mm Ø	<b>F13-181</b> 12.5mm Ø	<b>F13-201</b> 25.0mm Ø
<b>F13-162</b> 2.5mm Ø	<b>F13-182</b> 13.0mm Ø	<b>F13-202</b> 26.0mm Ø
<b>F13-163</b> 3.0mm Ø	<b>F13-183</b> 13.5mm Ø	<b>F13-203</b> 27.0mm Ø
<b>F13-164</b> 3.5mm Ø	<b>F13-184</b> 14.0mm Ø	<b>F13-204</b> 28.0mm Ø
<b>F13-165</b> 4.0mm Ø	<b>F13-185</b> 14.5mm Ø	<b>F13-205</b> 29.0mm Ø
<b>F13-166</b> 4.5mm Ø	<b>F13-186</b> 15.0mm Ø	<b>F13-206</b> 30.0mm Ø
<b>F13-167</b> 5.0mm Ø	<b>F13-187</b> 15.5mm Ø	
<b>F13-168</b> 5.5mm Ø	<b>F13-188</b> 16.0mm Ø	
<b>F13-169</b> 6.0mm Ø	<b>F13-189</b> 16.5mm Ø	
<b>F13-170</b> 7.0mm Ø	<b>F13-190</b> 17.0mm Ø	
<b>F13-171</b> 7.5mm Ø	<b>F13-191</b> 17.5mm Ø	
<b>F13-172</b> 8.0mm Ø	<b>F13-192</b> 18.0mm Ø	
<b>F13-173</b> 8.5mm Ø	<b>F13-193</b> 18.5mm Ø	
<b>F13-174</b> 9.0mm Ø	<b>F13-194</b> 19.0mm Ø	
<b>F13-175</b> 9.5mm Ø	<b>F13-195</b> 19.5mm Ø	
<b>F13-176</b> 10.0mm Ø	<b>F13-196</b> 20.0mm Ø	
<b>F13-177</b> 10.5mm Ø	<b>F13-197</b> 21.0mm Ø	
<b>F13-178</b> 11.0mm Ø	<b>F13-198</b> 22.0mm Ø	

**Hegar Uterine Dilator**  
single ended

**F13-207** 4 mm - 17 mm Ø  
8 Pieces per set  
**F13-208** 1 mm - 26 mm Ø  
24 Pieces per set

**Hegar Uterine Dilator**  
single ended

**F13-209** 4 mm - 17 mm Ø  
24 pieces per set

**Hegar uterine dilator**

<b>F13-210</b> 1 / 2 mm Ø
<b>F13-211</b> 3 / 4 mm Ø
<b>F13-212</b> 5 / 6 mm Ø
<b>F13-213</b> 7 / 8 mm Ø
<b>F13-214</b> 9 / 10 mm Ø
<b>F13-215</b> 11 / 12 mm Ø
<b>F13-216</b> 13 / 14 mm Ø
<b>F13-217</b> 15 / 16 mm Ø
<b>F13-218</b> 17 / 18 mm Ø
<b>F13-219</b> 19 / 20 mm Ø
<b>F13-220</b> 21 / 22 mm Ø
<b>F13-221</b> 23 / 24 mm Ø
<b>F13-222</b> 25 / 26 mm Ø

double ended

**Hegar uterine dilator**

**F13-223** 3 / 4 mm - 17 / 18 mm Ø  
3 Pieces per set  
**F13-224** 1 / 2 mm - 25 / 26 mm Ø  
14 Pieces per set





**Hegar Uterine Dilator, Double-ended**

- F13-225 3mm & 4mm, 7 7/8" (20cm)
- F13-226 5mm & 6mm, 7 7/8" (20cm)
- F13-227 7mm & 8mm, 7 7/8" (20cm)
- F13-228 9mm & 10mm, 7 7/8" (20cm)
- F13-229 11mm & 12mm, 7 7/8" (20cm)
- F13-230 13mm & 14mm, 7 7/8" (20cm)
- F13-231 15mm & 15mm, 7 7/8" (20cm)
- F13-232 17mm & 19mm, 7 7/8" (20cm)

**Hegar Uterine Dilators 8 Set W/Roll**
**F13-233 Complete Set**

Curved, Delicate, 3mm to 15mm, Curved

**Hank Dilator**

- F13-234 Fig. 10 / 10 4.6 / 5.0 mm Ø
- F13-235 Fig. 11 / 12 6.5 / 6.0 mm Ø
- F13-236 Fig. 13 / 14 6.5 / 7.0 mm Ø
- F13-237 Fig. 15 / 16 7.5 / 8.0 mm Ø
- F13-238 Fig. 17 / 18 8.5 / 9.0 mm Ø
- F13-239 Fig. 19 / 20 9.5 / 10.0 mm Ø

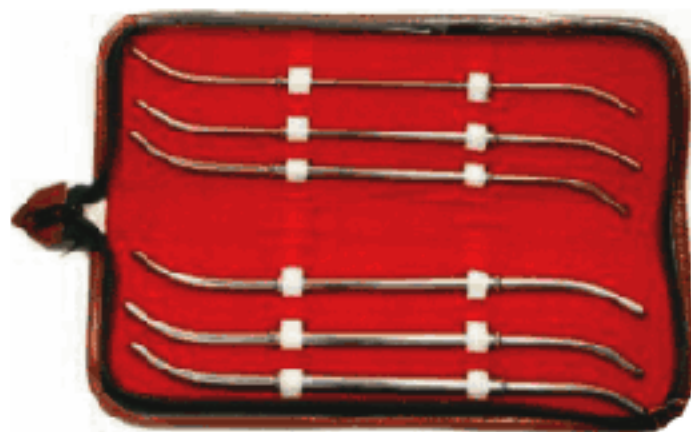
**Hank Dilator set**
**F13-240 Fig. 4.5 / 6 mm 9.5 / 10.0 mm Ø**  
 5 Pieces per set

*Parametriumklemmen, Hysterektomieklemmen* | *Pinzas parametrium, Pinzas-clamps para hysterectomia*  
*Pinces parametrium, Pinces à hystérectomie* | *Pinze parametrium, Pinze per isterectomia*



**Parametrium  
Hysterectomy  
Forceps**

<b>F13-241</b> 21.0 cm 8 1/4"	<b>F13-245</b> 21.0 cm 8 1/4"	<b>F13-249</b> 21.0 cm 8 1/4"	<b>F13-253</b> 21.0 cm 8 1/4"	<b>F13-257</b> 21.0 cm 8 1/4"
<b>F13-242</b> 24.0 cm 9 1/2"	<b>F13-246</b> 24.0 cm 9 1/2"	<b>F13-250</b> 24.0 cm 9 1/2"	<b>F13-254</b> 24.0 cm 9 1/2"	<b>F13-258</b> 24.0 cm 9 1/2"
<b>F13-243</b> 30.0 cm 12"	<b>F13-247</b> 30.0 cm 12"	<b>F13-251</b> 30.0 cm 12"	<b>F13-255</b> 30.0 cm 12"	<b>F13-259</b> 30.0 cm 12"
<b>F13-244</b> 35.0 cm 13 3/4"	<b>F13-248</b> 35.0 cm 13 3/4"	<b>F13-252</b> 35.0 cm 13 3/4"	<b>F13-256</b> 35.0 cm 13 3/4"	<b>F13-260</b> 35.0 cm 13 3/4" S-curved



**Rogers Parametrium  
Hysterectomy Forceps**

<b>F13-261</b> Fig. 1 22.0 cm 8 3/4"	<b>F13-262</b> Fig. 2 21.5 cm 8 1/2"	<b>F13-263</b> Fig. 3 21.0 cm 8 1/4"	<b>F13-264</b> Fig. 4 20.5 cm 8"
<b>F13-265</b> Fig. 1 26.0 cm 10 3/4"	<b>F13-266</b> Fig. 2 26.0 cm 10 3/4"	<b>F13-267</b> Fig. 3 24.5 cm 9 1/2"	<b>F13-268</b> Fig. 4 23.0 cm 9"

*Hakenzangen*
*Pinzas para coger el cuello del útero*
*Pinces pour l'abaissement du col de l'utérus*
*Pinze per abbassare il collo dell'utero*

**Staudt - Moore**  
Tenaculum Forceps  
F13-269  
17.0 cm 6 3/4"



**Barrett**  
Tenaculum Forceps  
F13-270  
18.0 cm 7"



**Schroeder-Braun**  
Tenaculum Forceps  
F13-271  
25.0 cm 9 3/4"



**Skene**  
Tenaculum Forceps  
F13-272  
24.0 cm 9 1/2"



**Pozzi Tenaculum Forceps**  
F13-273 25.5 cm 10"



**Schroeder Tenaculum Forceps**  
F13-274 25.0 cm 9 3/4"

*Hakenzangen*
*Pinzas para coger el cuello del útero*
*Pinces pour l'abaissement du col de l'utérus*
*Pinze per abbassare il collo dell'utero*

**Schroeder Vuissellum  
Tenaculum Forceps**



**F13-275**  
24.0 cm 9 1/2"



**F13-276**  
24.0 cm 9 1/2"



**Duplay Tenaculum  
Forceps**  
F13-277 26.0 cm 11"



**Iowa Tenaculum Forceps**  
F13-278 26.0 cm 10 1/4"



**Deacham Amnicotome**  
F13-279 26.0 cm 10 1/4"



**Pratt Tenaculum Forceps**  
F13-280  
25.0 cm 10 1/4"



**Czerny Tenaculum Forceps**  
F13-281  
20.5 cm 8"

*Hakenzangen*
*Pinzas para coger el cuello del útero*
*Pinces pour l'abaissement du col de l'utérus*
*Pinze per abbassare il collo dell'utero*

**Museux Tenaculum Forceps**

<b>F13-282</b> 8 mm	<b>F13-285</b>
<b>F13-283</b> 6 mm	<b>F13-286</b>
<b>F13-284</b> 10 mm	<b>F13-287</b>
24.0 cm 9 1/2"	24.0 cm 1"

**Jacobs Uterine Vulsellum Forceps**
**F13-288**  
21.0 cm 8 1/4"

**F13-289**  
21.0 cm 8 1/4"

**Teale Tenaculum Forceps**  
**F13-290**  
25.0 cm 9"

**Gellhorn Biopsy Forceps**  
**F13-291**  
23.0 cm 9"

**Thomas-Gaylor Biopsy Forceps**  
**F13-292** 22.0 cm 8 3/4"  
**F13-293** 24.0 cm 9 1/2"

*Proneexzisionszangen*
*Pinças para-biopsia para biopsia*
*Pinças emporte-pièces à biopsie*
*Pinze taglianti per biopsia*

**Schubert Biopsy Forceps**  
**F13-294** 21.0 cm 8 1/8"  
**F13-295** 23.0 cm 11"



**Faure Uterine Biopsy Forceps**  
**F13-296** 21.0 cm 8 1/8"



**Schubert Biopsy Forceps**  
**F13-297** 26.0 cm 10 1/4"



**Van Dorn Biopsy Forceps**  
**F13-298**  
 24.0 cm 9 1/2"



**Schumacher Biopsy Forceps**

**Fig. 1**  
**F13-299**  
 24.0 cm 9 1/2"

**Fig. 2**  
**F13-300**  
 24.0 cm 9 1/2"

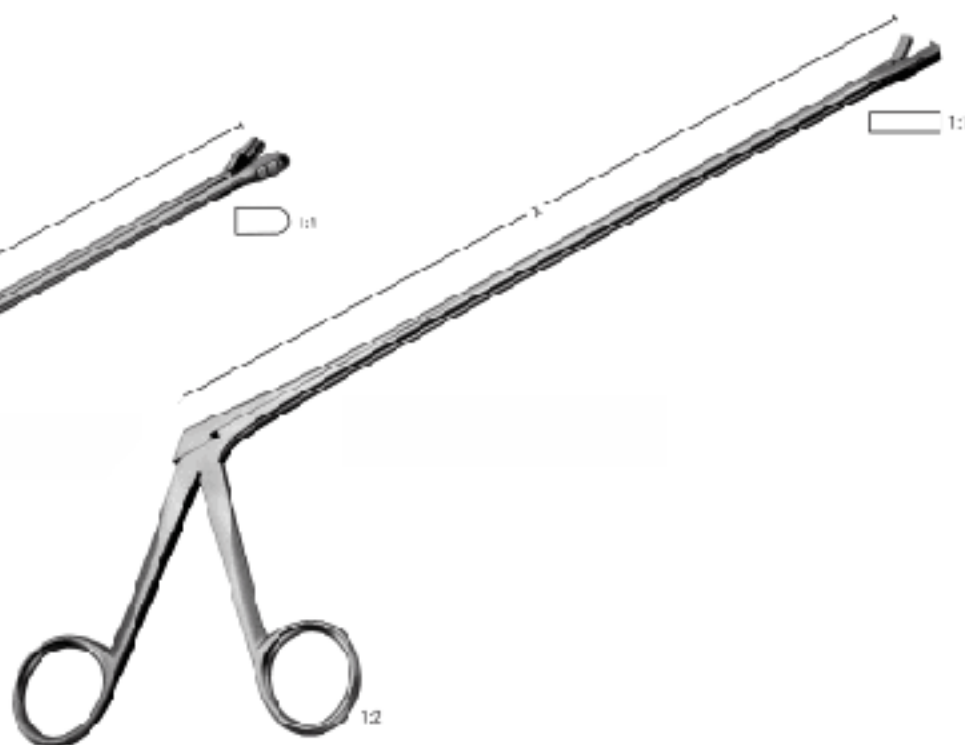
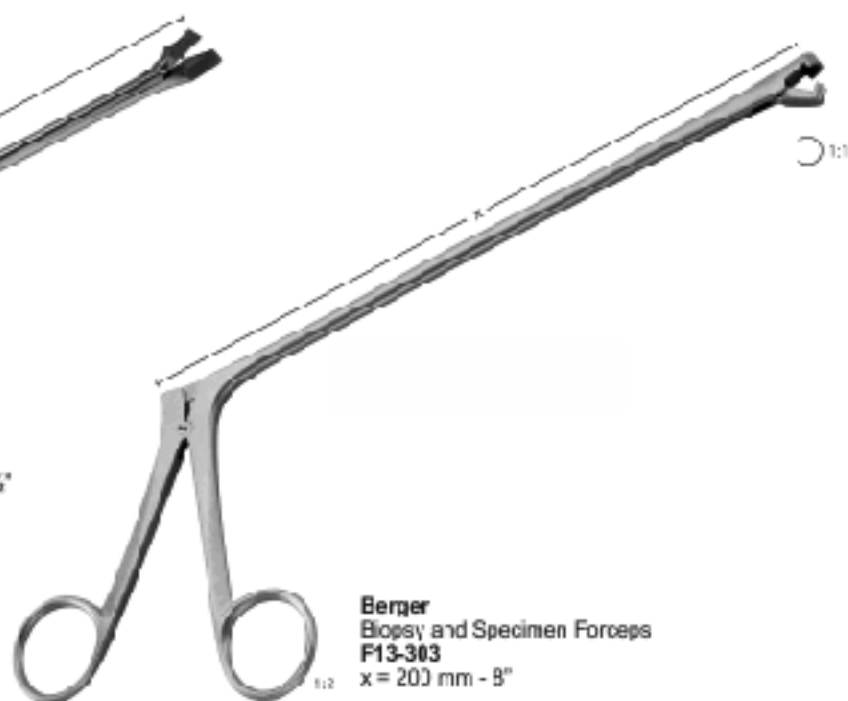
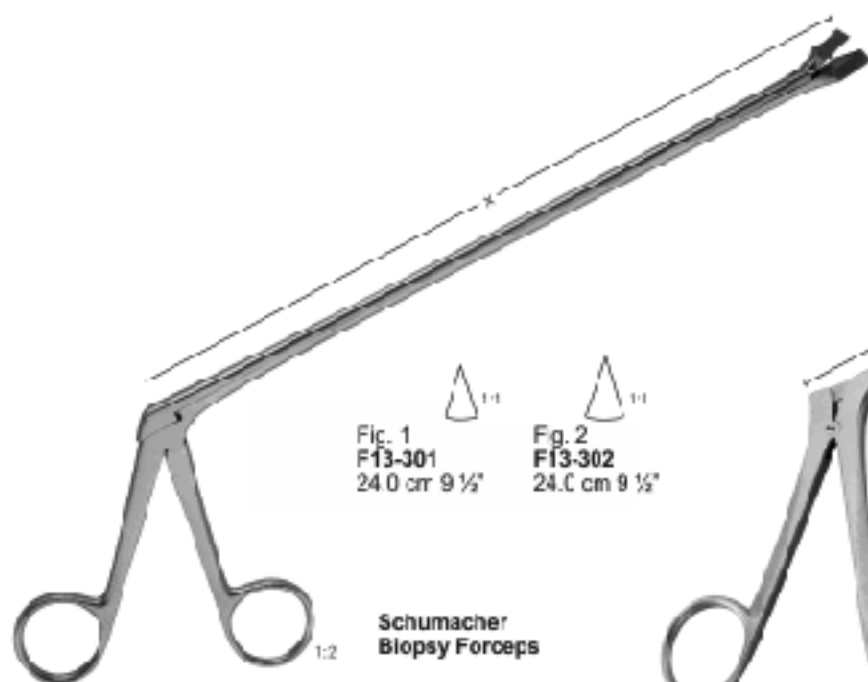
*Proneexzisionszangen*
*Pinças amo-biopsia para biopsia*
*Pinces emporte-pièces à biopsie*
*Pinze taglianti per biopsia*

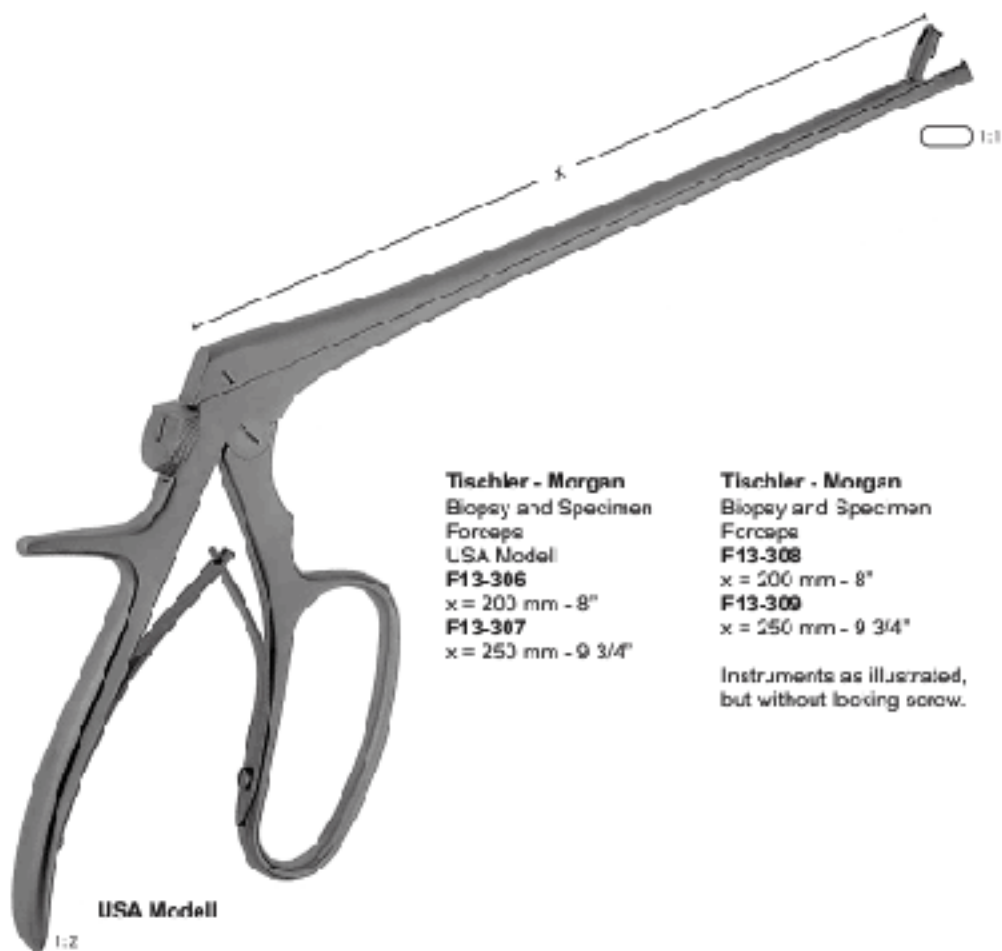
*Proneexzisionszangen*
*Pinças amo-biopsia*
*Pinces emporte-pièces à biopsie*
*Pinze taglianti per biopsia*

**Tischler - Morgan**  
Biopsy and Specimen  
Forceps  
USA Model  
**F13-306**  
x = 203 mm - 8"  
**F13-307**  
x = 253 mm - 9 3/4"

**Tischler - Morgan**  
Biopsy and Specimen  
Forceps  
**F13-308**  
x = 200 mm - 8"  
**F13-309**  
x = 250 mm - 9 3/4"

Instruments as illustrated,  
but without locking screw.

USA Model

1:2

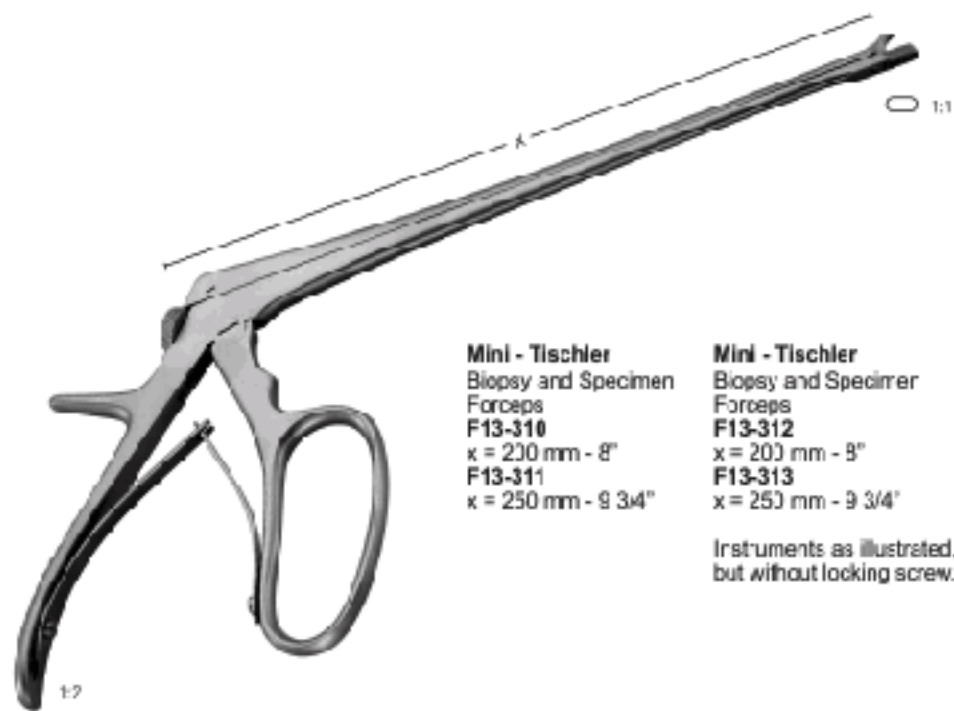

**Mini - Tischler**  
Biopsy and Specimen  
Forceps  
**F13-310**  
x = 220 mm - 8"  
**F13-311**  
x = 250 mm - 9 3/4"

**Mini - Tischler**  
Biopsy and Specimen  
Forceps  
**F13-312**  
x = 203 mm - 8"  
**F13-313**  
x = 253 mm - 9 3/4"

Instruments as illustrated,  
but without locking screw.

1:2





**Segond  
Myoma Knife  
Fistula Hook**  
F13-314  
27.0 cm 10 3/4"

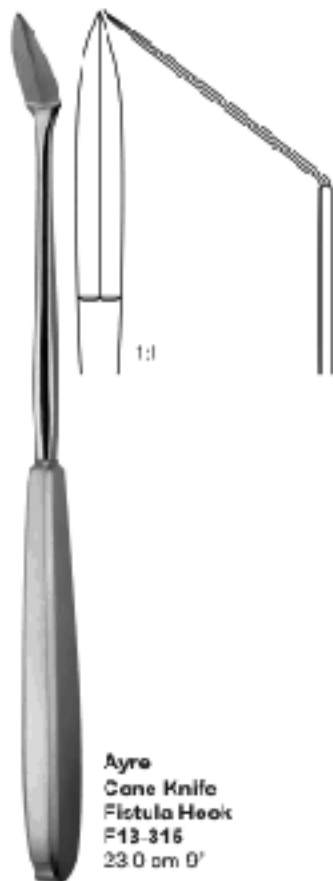

**Ayre  
Cone Knife  
Fistula Hook**  
F13-316  
23.0 cm 9"



**Doyen  
Myoma Screw  
And Fistula Hook**  
F13-316  
17.0 cm 6 3/4"



**Fig 1  
F13-317  
22.0 cm 8 3/4"**



**Simon  
Fistula Hook,  
One Prong**



**Fig 2  
F13-318  
22.0 cm 8 3/4"**



**Simon  
Fistula Hook,  
Two Prong**



**Fig 1  
F13-319  
22.0 cm 8 3/4"**



**Fig 2  
F13-320  
22.0 cm 8 3/4"**



**Fig 3  
F13-321  
22.0 cm 8 3/4"**



**Fig 4  
F13-322  
22.0 cm 8 3/4"**



**Fig 5  
F13-323  
22.0 cm 8 3/4"**



**Emmet  
Fistula Hook**



**Uni - Randall**  
aspirating curette  
**F13-324** 4 mm Ø  
24.0 cm 9 1/2"



**Novak**  
aspirating curette  
**F13-325** 4 mm Ø  
23.0 cm 9"

**Mini - Novak**  
aspirating curette  
23.5 cm 9 1/4"  
**F13-326** 1 mm Ø  
**F13-327** 2 mm Ø  
**F13-328** 3 mm Ø



**Uni - Randall**  
aspirating curette  
**F13-329**  
30.0 cm 12"  
rigid, without basket

**Uni - Randall**  
aspirating curette  
**F13-330**  
30.0 cm 12"  
malleable,  
without basket



**Uni - Randall**  
aspirating curette  
**F13-331**  
30.0 cm 12"  
rigid, with basket

**Uni - Randall**  
aspirating curette  
**F13-332**  
30.0 cm 12"  
malleable,  
with basket

**Specimen And**  
**Aspirating Curette**  
20.0 cm 11 1/2"  
**F13-333** 3 mm Ø  
**F13-334** 4 mm Ø  
**F13-335** 6 mm Ø  
**F13-336** 8 mm Ø  
**F13-337** 10 mm Ø  
**F13-338** 12 mm Ø  
**F13-339** 14 mm Ø

**Coupling Piece**  
aspirating curette  
12.0 cm 4 3/4"  
**F13-340**



**Brain Uterine Depressor**  
**F13-341** 28.0 cm 11"



**Blake Double Ended**  
**F13-342** 245mm (9.3/4")  
Sharp / Blunt



**Zwifal Double Ended**  
**F13-343** 245mm (9.3/4")  
Sharp / Sharp

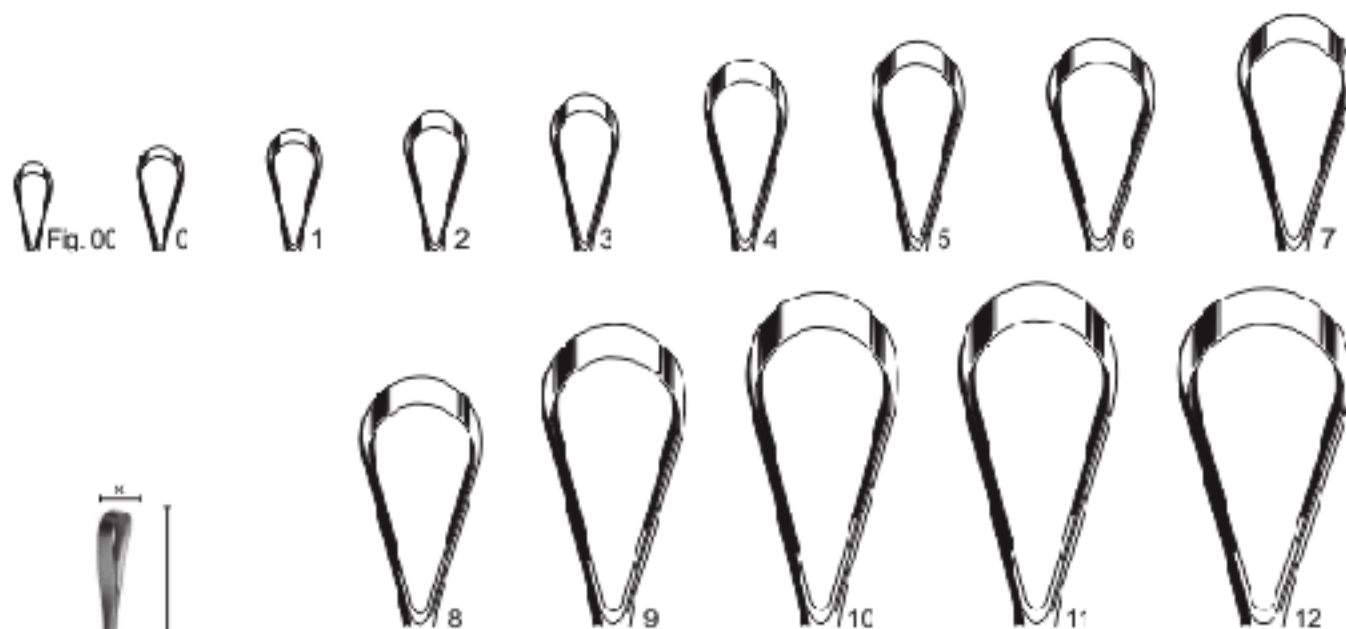

<b>Recamier</b> uterine curette $y=26.0\text{ cm } 10\ 1/4"$	Fig.	$x=\text{mm}$	Sharp, malleable	Blunt, malleable	Sharp, rigid	Blunt, rigid
	00	5	F13-344	F13-358	F13-372	F13-386
	0	6	F13-345	F13-359	F13-373	F13-387
	1	7	F13-346	F13-360	F13-374	F13-388
	2	8	F13-347	F13-361	F13-375	F13-389
	3	9	F13-348	F13-362	F13-376	F13-390
	4	11	F13-349	F13-363	F13-377	F13-391
	5	12	F13-350	F13-364	F13-378	F13-392
	6	14	F13-351	F13-365	F13-379	F13-393
	7	15	F13-352	F13-366	F13-380	F13-394
	8	16	F13-353	F13-367	F13-381	F13-395
	9	19	F13-354	F13-368	F13-382	F13-396
	10	20	F13-355	F13-369	F13-383	F13-397
	11	21	F13-356	F13-370	F13-384	F13-398
	12	23	F13-357	F13-371	F13-385	F13-399

<b>Recamier</b> uterine curette $y=31.0\text{ cm } 12\ 1/4"$	Fig.	$x=\text{mm}$	Sharp, malleable	Blunt, malleable	Sharp, rigid	Blunt, rigid
	00	5	F13-400	F13-414	F13-428	F13-442
	0	6	F13-401	F13-415	F13-429	F13-443
	1	7	F13-402	F13-416	F13-430	F13-444
	2	8	F13-403	F13-417	F13-431	F13-445
	3	9	F13-404	F13-418	F13-432	F13-446
	4	11	F13-405	F13-419	F13-433	F13-447
	5	12	F13-406	F13-420	F13-434	F13-448
	6	14	F13-407	F13-421	F13-435	F13-449
	7	15	F13-408	F13-422	F13-436	F13-450
	8	16	F13-409	F13-423	F13-437	F13-451
	9	19	F13-410	F13-424	F13-438	F13-452
	10	20	F13-411	F13-425	F13-439	F13-453
	11	21	F13-412	F13-426	F13-440	F13-454
	12	23	F13-413	F13-427	F13-441	F13-455

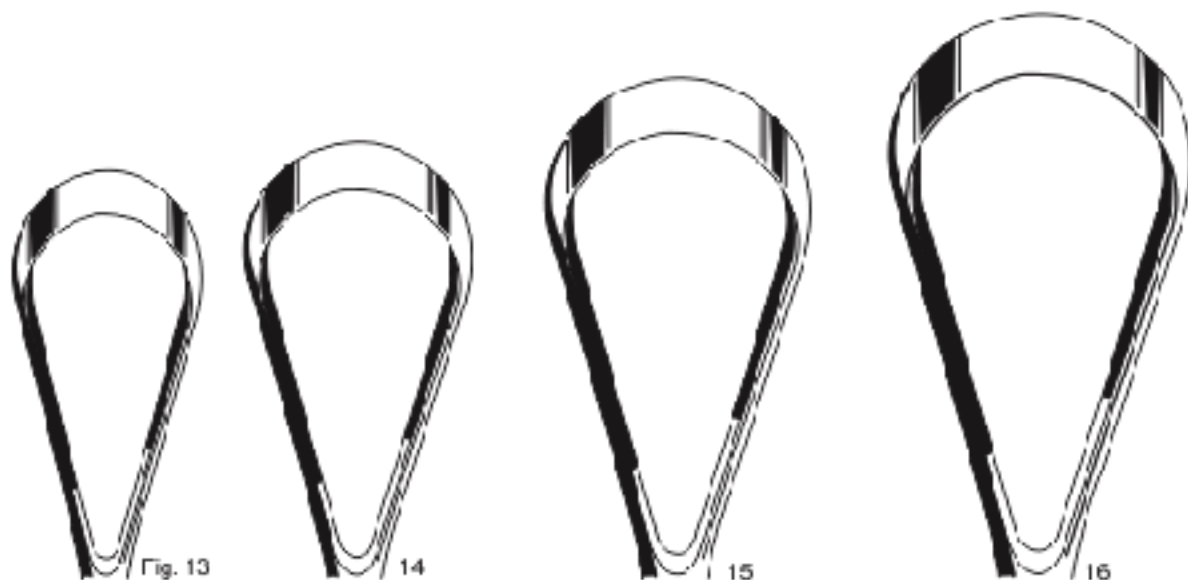

	Fig.	x=mm	Sharp, malleable	Blunt, malleable	Sharp, rigid	Blunt, rigid
<b>Recamier</b> uterine curette y=34.0 cm 13 1/2"	13	25	F13-456	F13-460	F13-464	F13-468
	14	30	F13-457	F13-461	F13-465	F13-469
	15	35	F13-458	F13-462	F13-466	F13-470
	16	40	F13-459	F13-463	F13-467	F13-471

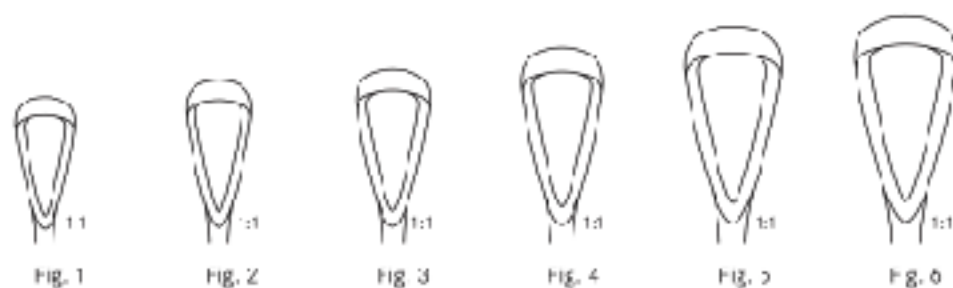

Fig.	x=mm	Sharp, malleable	Blunt, malleable	Sharp, rigid	Blunt, rigid
1	7	F13-472	F13-478	F13-484	F13-490
2	8	F13-473	F13-479	F13-485	F13-491
3	9	F13-474	F13-480	F13-486	F13-492
4	11	F13-475	F13-481	F13-487	F13-493
5	12	F13-476	F13-482	F13-488	F13-494
6	14	F13-477	F13-483	F13-489	F13-495

**Sims**  
uterine curette  
27.0 cm 11"



Schröder  
Uterine Spoon



Fig. 1  
F13-496  
25.0 cm 9 3/4"  
Sharp, rigid



Fig. 2  
F13-497  
25.0 cm 9 3/4"  
Sharp, rigid



Fig. 3  
F13-498  
25.0 cm 9 3/4"  
Sharp, rigid



Fig. 4  
F13-499  
25.0 cm 9 3/4"  
Sharp, rigid



Fig. 5  
F13-500  
25.0 cm 9 3/4"  
Sharp, rigid



Fig. 6  
F13-501  
25.0 cm 9 3/4"  
Sharp, rigid



Schröder  
Uterine Spoon



Fig. 1  
F13-502  
30.0 cm 12"



Fig. 2  
F13-503  
30.0 cm 12"



Fig. 3  
F13-504  
30.0 cm 12"



Fig. 4  
F13-505  
30.0 cm 12"



Fig. 5  
F13-506  
30.0 cm 12"



Fig. 6  
F13-507  
30.0 cm 12"

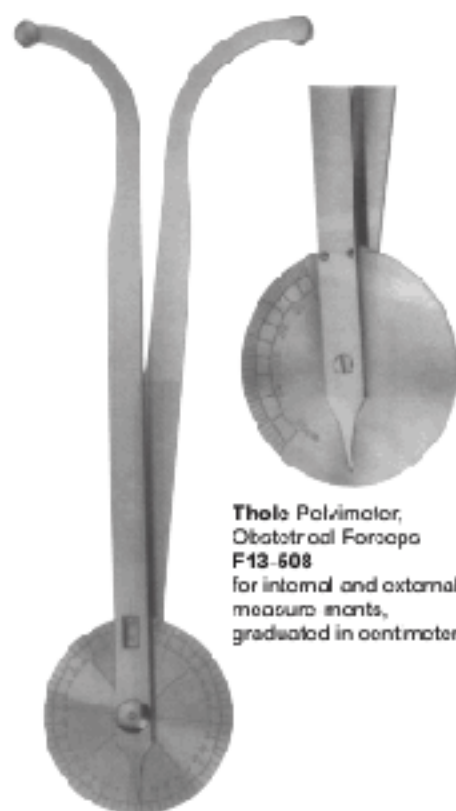

**Thole Pelvimeter,**  
Obstetrical Forceps  
**F13-608**  
for internal and external  
measurements,  
graduated in centimeters



**De Lee Pelvimeter,**  
Obstetrical Forceps  
**F13-609**  
graduated in centimeters  
and inches



**Collin Pelvimeter,**  
Obstetrical Forceps  
**F13-510**  
Graduated in  
Centimeters



**Martin Pelvimeter,**  
Obstetrical Forceps  
**F13-511**  
graduated in  
centimeters



for internal measurements  
between symphysis and  
promontory



**Collin Pelvimeter,**  
Obstetrical Forceps  
**F13-512**  
graduated in centimeters

The additional straight arm  
can be replaced. The pelvimeter  
with straight arm is used for  
localisation of the portio vaginalis  
ureth and of vaginal metastasis.



**Breisky Pelvimeter,**  
Obstetrical Forceps  
**F13-513**  
graduated in  
centimeters



**Simpson**  
obstetrical forceps  
**F13-514**  
30.0 cm 12"



**Simpson - Braun**  
obstetrical forceps  
**F13-515** 33.0 cm 13"  
**F13-516** 36.0 cm 14 1/4"



**Naegle**  
obstetrical forceps  
**F13-517** 36.0 cm 14 1/4"  
**F13-518** 40.0 cm 15"



**Piper**  
obstetrical forceps  
**F13-519**  
44.0 cm 17 1/4"



**Simpson - Luskart**  
obstetrical forceps  
**F13-520**  
36.0 cm 14 1/4"



**Wrigley**  
obstetrical forceps  
**F13-521** 25.0 cm 9 3/4"  
for caesarian section



**De Lee**  
obstetrical forceps  
**F13-522**  
30.0 cm 12"



**De Lee**  
obstetrical forceps  
**F13-523** 36.0 cm 14 1/4"  
**F13-524** 15.0 cm 5 7/8"

Geburtszangen  
Forceps obstétriques

Forceps obstétricos  
Forcipi



**Elliot**  
obstetrical forceps  
F13-525 32.0 cm 12 1/2"  
F13-526 38.0 cm 15"



**McLean**  
obstetrical forceps  
F13-527 36.0 cm 14 1/4"



**Kielland**  
obstetrical forceps  
F13-528 41.0 cm 16 1/4"



**Kielland-Lukart**  
obstetrical forceps  
F13-529 40.0 cm 15"



**Braun**  
obstetrical forceps  
F13-530  
42.0 cm 16 1/2"  
Cranioclast, one  
jaw fenestrated



**Tarnier**  
obstetrical forceps  
F13-531  
48.0 cm 17 1/4"  
Basiotribe



**Sellheim**  
Obstetrical Lever  
F13-532  
28.0 cm 11"



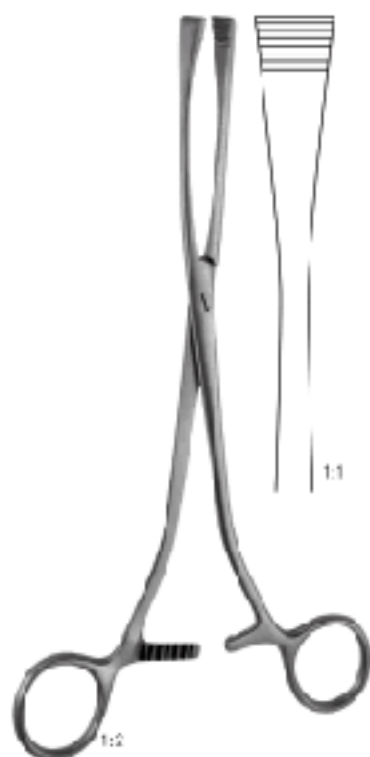

**Green-Armstrong**  
 Uterine Flexing Forceps  
 F13-533 21.0 cm 8 1/4"



**Smellie**  
 Obstetrical Forceps  
 F13-534 25.0 cm 10"  
 Perforator

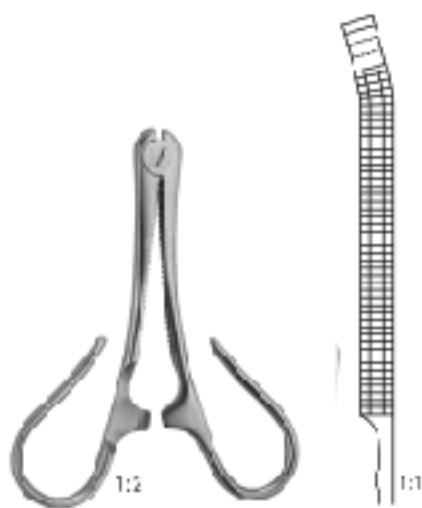

**Kane**  
 obstetrical forceps  
 F13-535  
 85.0 cm 3 1/4"



**Collin**  
 obstetrical forceps  
 F13-536  
 90.0 cm 3 5/8"



**Braun, Midwifery**  
 Decapitating hook  
 F13-537  
 32.5 cm 12 3/4"

*Abortuszangen - Abortusküretten*
*Pinzas para abort - Curetas para aborto*
*Pinces à jaws germes - Curette d'avortement*
*Pinze per placenta ed aborto - Curette per placenta ed aborto*

**Winter**  
abortion forceps

**Fig. 1**  
**F13-538**  
28.0 cm 11"  
straight

**F13-539**  
28.0 cm 11"  
curved



**Fig. 2**  
**F13-540**  
28.0 cm 11"  
straight

**F13-541**  
28.0 cm 11"  
curved



**Fig. 3**  
**F13-542**  
28.0 cm 11"  
straight

**F13-543**  
28.0 cm 11"  
curved



**Cuzzi**  
ovum curette  
blunt, back serrated



Cuzzi



14.5 mm  
**F13-544**  
30.0 cm 12"



18.0 mm  
**F13-545**  
30.0 cm 12"



21.0 mm  
**F13-546**  
30.0 cm 12"



**Saenger**  
abortion forceps



**F13-547**  
27.0 cm 10 3/4"  
Straight



**F13-548**  
27.0 cm 10 3/4"  
Curved



**Wallich**  
ovum curette  
**F13-549** 42.0 cm 16 1/2"



**Pestalozza**  
ovum curette  
**F13-550** 30.0 cm 12"



# UROLOGY INSTRUMENTS

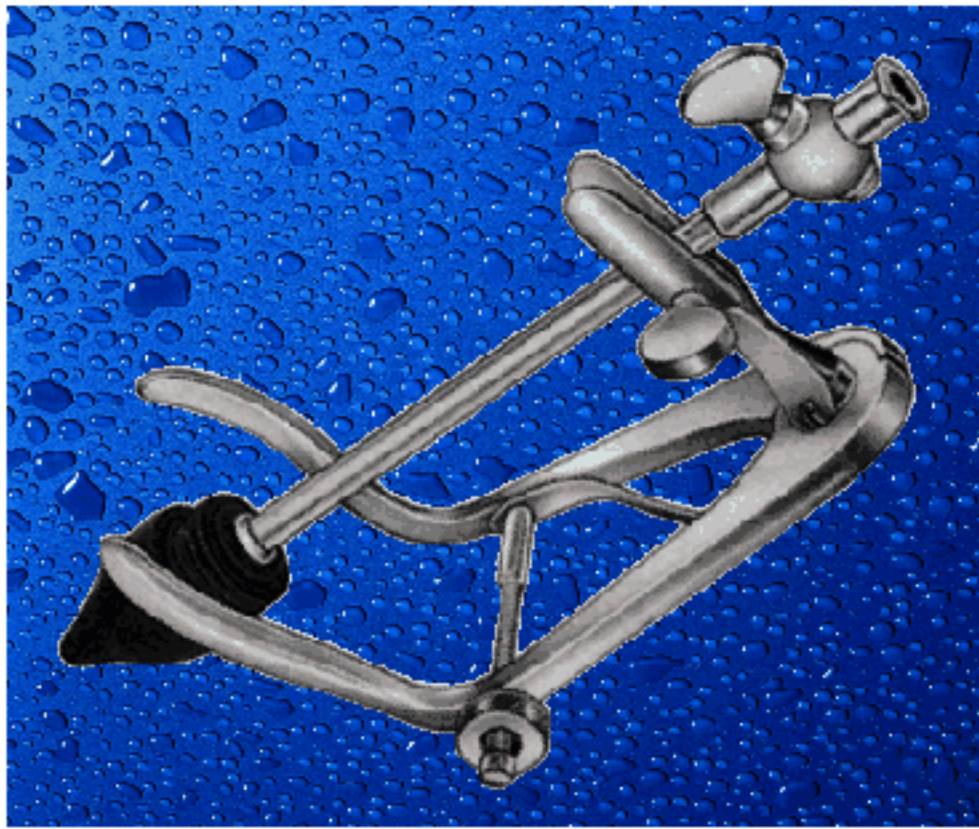

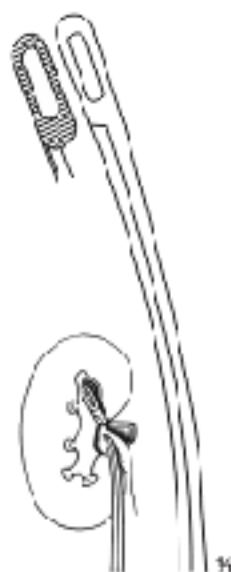
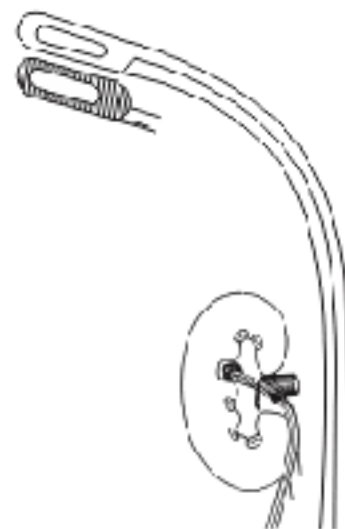
**Randall Kidney Stone Clamps Forceps**

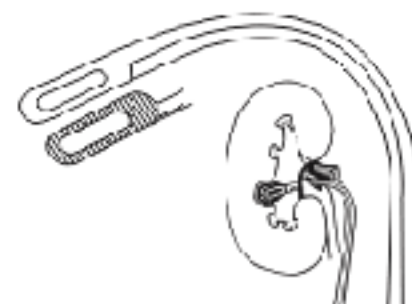
**F14-001**  
 23 cm, 9"  
 quarter curved

**F14-002**  
 23 cm, 9"  
 half curved

**F14-003**  
 23 cm, 9"  
 full curved

**F14-004**  
 23 cm, 9"  
 three quarter curved



**Dartigue's Lithine Elevating Forceps**  
F14-005  
27 cm, 10 3/4"



**Collin Kidney Elevating Stone Clamps Forceps**  
F14-006  
29.5 cm, 11 1/2"



**Hulka-Kerwick Lithine Elevating & Manipulating Forceps**  
F14-007  
27.3 cm, 11"



**Somer Kidney Elevating Stone Clamps Forceps**  
F14-008  
23.5 cm, 9"



**Strassmann Kidney Elevating Stone Clamps Forceps**  
F14-009  
26 cm, 10 1/4"



**Collin Kidney Elevating Stone Clamps Forceps**  
F14-010  
26.5 cm, 10 1/2"



**Collin Kidney Elevating Stone Clamps Forceps**  
F14-011  
25 cm, 10 1/4"

11 x 50 mm

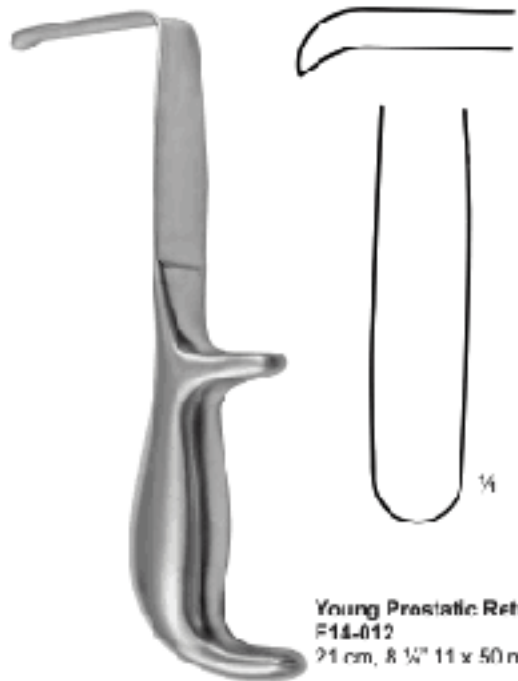

**Young Prostatic Retractor**  
**F14-012**  
 21 cm, 8 1/4" 11 x 50 mm

38 x 64 mm

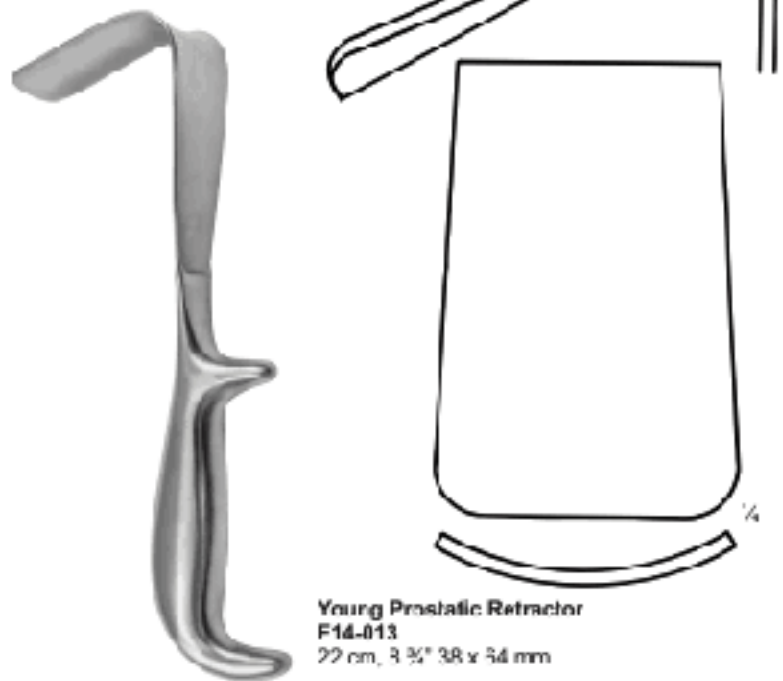

**Young Prostatic Retractor**  
**F14-013**  
 22 cm, 8 3/4" 38 x 64 mm

25 x 25 mm

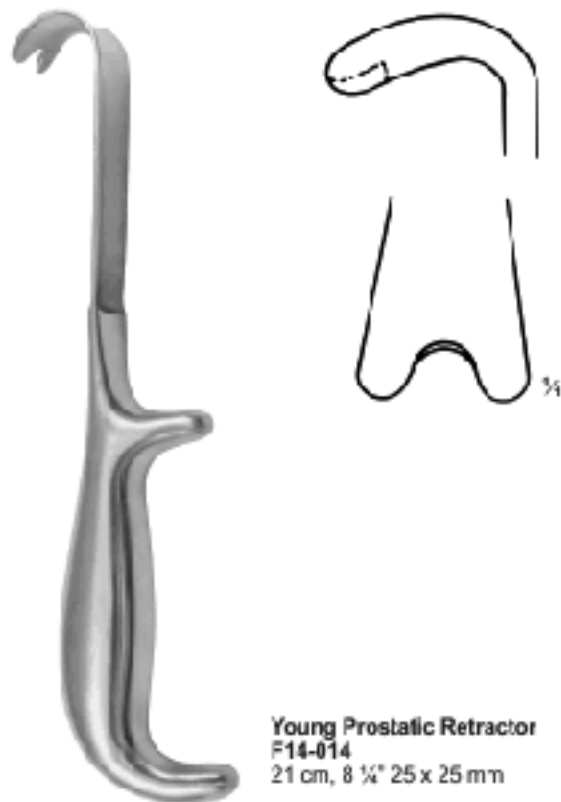

**Young Prostatic Retractor**  
**F14-014**  
 21 cm, 8 1/4" 25 x 25 mm

39 x 35 mm

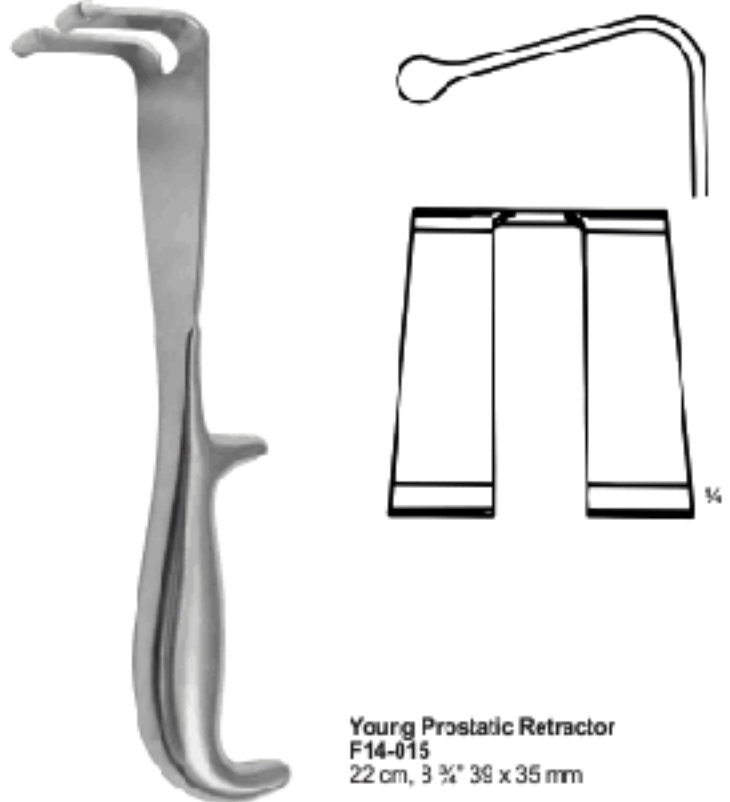

**Young Prostatic Retractor**  
**F14-015**  
 22 cm, 8 3/4" 39 x 35 mm



**Moynihan**  
F14-020  
34.0 cm, 13 1/2"



**Bakes Common Bile**  
Duct Dilators, Malleable  
Set of 13, 32 cm, 13"

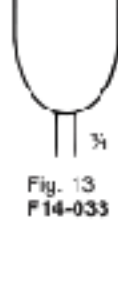

**Luer-Koerte**  
Modif With  
Malleable Shaft  
31 cm, 12.20"

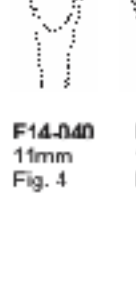
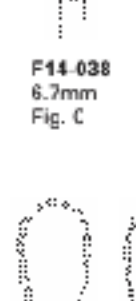
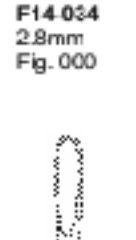



**Catheter**  
**F14-042**  
 16 cm, 6"  
 No. 6-10



**Catheters**  
**F14-043** 26 cm, 11 1/2"  
 Male Catheters charr, Metal  
 French  
**F14-044** 0  
**F14-045** 10  
**F14-046** 12  
**F14-047** 14  
**F14-048** 16  
**F14-049** 18  
**F14-050** 20



**Lister Bougies**  
**F14-051**  
 27 cm, 10 3/4"  
 00 / 1 to 15 / 10  
 set of 17



**Clutton Bougies**  
**F14-052** 27 cm, 10 3/4"  
 06 / 10 FG to 23 / 32  
 set of 12



**Van Buren**  
**Urethral Sound**  
**A TO O**  
 Set of 15

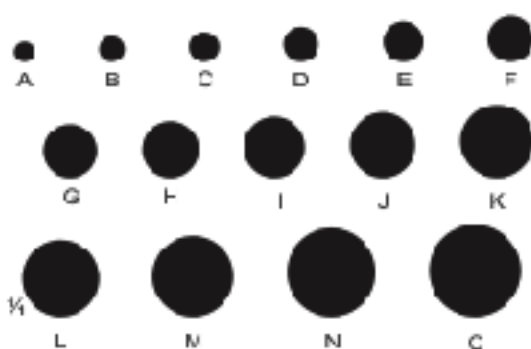
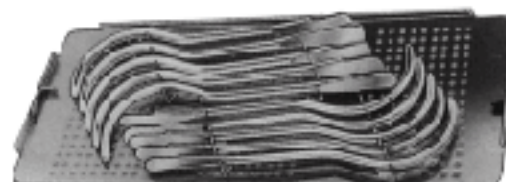
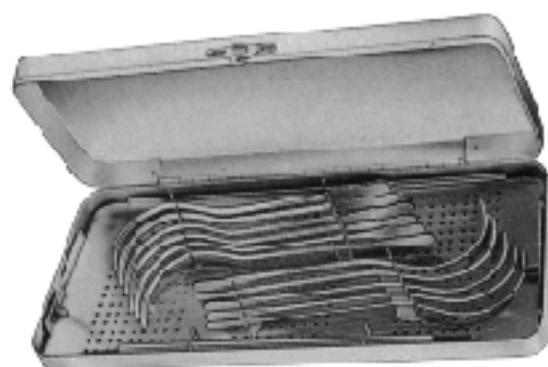

Fig.	Item	Description	Inches	Dia. Charr
A	F14-053	28 cm	1 1/8"	8 French
B	F14-054	28 cm	1 1/4"	10 French
C	F14-055	28 cm	1 1/2"	12 French
D	F14-056	28 cm	1 3/4"	14 French
E	F14-057	28 cm	1 7/8"	16 French
F	F14-058	28 cm	2"	18 French
G	F14-059	28 cm	2 1/8"	20 French
H	F14-060	28 cm	2 1/4"	22 French
I	F14-061	28 cm	2 1/2"	24 French
J	F14-062	28 cm	2 3/4"	26 French
K	F14-063	28 cm	2 7/8"	28 French
L	F14-064	28 cm	3"	30 French
M	F14-065	28 cm	3 1/8"	32 French
N	F14-066	28 cm	3 1/4"	34 French
O	F14-067	28 cm	3 1/2"	36 French



**Guyon**  
**F14-058**  
 420 x 175 x 40 mm  
 Set in metal case containing  
 — 21 Bougies Guyon  
 — 6 Filiform Bougies





	Char. (French)
F14-870	8
F14-871	9
F14-872	10
F14-873	11
F14-874	12
F14-875	13
F14-876	14
F14-877	15
F14-878	16
F14-879	17
F14-880	18
F14-881	19
F14-882	20
F14-883	21
F14-884	22
F14-885	23
F14-886	24
F14-887	26
F14-888	26
F14-889	27
F14-890	28
F14-891	29
F14-892	30

**Nittel**  
F14-059  
22.5 cm, 8 3/4"  
urethral bougies and  
dilating sounds



	Charr. (French)
F14-094	8
F14-095	9
F14-096	10
F14-097	11
F14-098	12
F14-099	13
F14-100	14
F14-101	15
F14-102	16
F14-103	17
F14-104	18
F14-105	19
F14-106	20
F14-107	21
F14-108	22
F14-109	23
F14-110	24
F14-111	26
F14-112	26
F14-113	27
F14-114	28
F14-115	29
F14-116	30

**Nittel**  
14-093  
35 cm, 14"  
urethral bougies and  
dilating sounds



**14-217**  
33 cm, 13"  
filiform guides  
olive tip



	Charr. (French)
F14-1103	
F14-1194	
F14-1205	
F14-1210	

**Guyon**  
F14-122  
25 cm, 10"  
urethral bougies and  
dilating sounds  
without filiform guides,  
with thread in tip

	Charr. (French)
F14-123	Ren. 24 / Charr. 12
F14-124	Ren. 25
F14-125	Ren. 26 / Charr. 13
F14-126	Ren. 27
F14-127	Ren. 28 / Charr. 14
F14-128	Ren. 29
F14-129	Ren. 30 / Charr. 15
F14-130	Ren. 31
F14-131	Ren. 32 / Charr. 16
F14-132	Ren. 33
F14-133	Ren. 34 / Charr. 17
F14-134	Ren. 35
F14-135	Ren. 36 / Charr. 18
F14-136	Ren. 37
F14-137	Ren. 38 / Charr. 19
F14-138	Ren. 39
F14-139	Ren. 40 / Charr. 20
F14-140	Ren. 41
F14-141	Ren. 42 / Charr. 21
F14-142	Ren. 43
F14-143	Ren. 44 / Charr. 22
F14-144	Ren. 45
F14-145	Ren. 46 / Charr. 23
F14-146	Ren. 47
F14-147	Ren. 48 / Charr. 24
F14-148	Ren. 49
F14-149	Ren. 50 / Charr. 25
F14-150	Ren. 51
F14-151	Ren. 52 / Charr. 26
F14-152	Ren. 53
F14-153	Ren. 54 / Charr. 27
F14-154	Ren. 55
F14-155	Ren. 56 / Charr. 28
F14-156	Ren. 57
F14-157	Ren. 58 / Charr. 29
F14-158	Ren. 59
F14-159	Ren. 60 / Charr. 30



**Blake Gall Stone Forceps**  
F14-160 20 cm, 8"  
Straight



**Blake Gall Stone Forceps**  
F14-161 20 cm, 8"  
Curved



**Uro-Tangential Gall Stone Forceps**



**F14-162**  
26 cm, 10 1/4"



**F14-163**  
26 cm, 10 1/4"



**Mayo-Blake Gall Stone Forceps**  
F14-164 20 cm, 8"  
Straight



**Mayo-Blake Gall Stone Forceps**  
F14-165 20 cm, 8"  
Curved



**Mixer Gall Stone Forceps**  
F14-166 22 cm, 8 3/4"



**Desjardins Gall Stone Forceps**  
F14-167 23 cm, 9"



**Desjardins Gall Stone Forceps**  
F14-168 23 cm, 9"



*Leistenhina Director, Vasectomie Zange, Schmiebstock & Blase Retractor*

*Directeur de hernie, Pinces de vasectomie, Clamp et le vessie enrouleur*

*Directoro Hernia, Pinzas vasectomia, abrazadera y la vejiga retractor*

*Direttore Emia, Pinze vasectomic, Clamp & vesicca Divaricatore*



**Child Hernia Director**  
F14-169



**Key Hernia Director**  
F14-170



**Teele Hernia Director**  
F14-171



**Millin Suction Tube**  
F14-172

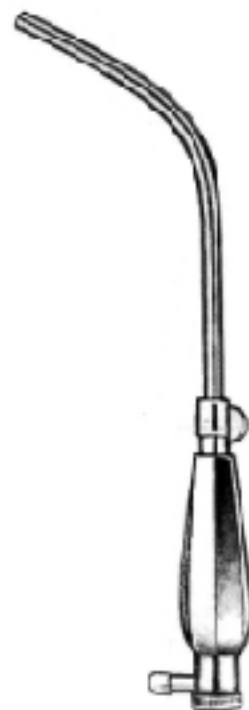

**Cord Hook**  
F14-173  
blunt 16cm



**Gutmann Secretions Scoop**  
F14-174 26cm



**No Scalpel Vasectomy Ringed Forceps Clamps**  
F14-175 14cm, 5.5"



**No Scalpel Vasectomy Hemostat Forceps**  
F14-176 14cm, 5.5"  
smooth sharp point; curved



**Leguani Bladder Retractor**  
F14-177



**Kocher's Bladder Retractor**  
F14-178 23.5cm, 9.25"

*Blasenhalssperrer, Blasenwindsperrer*
*Ecarteur pour le col de la vessie, Écarteurs vésicaux*
*Dilatador para el cuello vesical, Separadores vesicales*
*Divaricatori del collo vescicale, Divaricatori vescicali*

**Knutson**  
F14-179  
18 cm, 7"  
Lreithiografe-instrument



F14-180  
Spara



**Winkelmann Circumcision Clamps**

F14-181 12 mm Ø

F14-182 16 mm Ø

F14-183 20 mm Ø



**Mogen Circumcision Clamp**  
F14-184



**Circumcision Shield**  
F14-185  
10cm

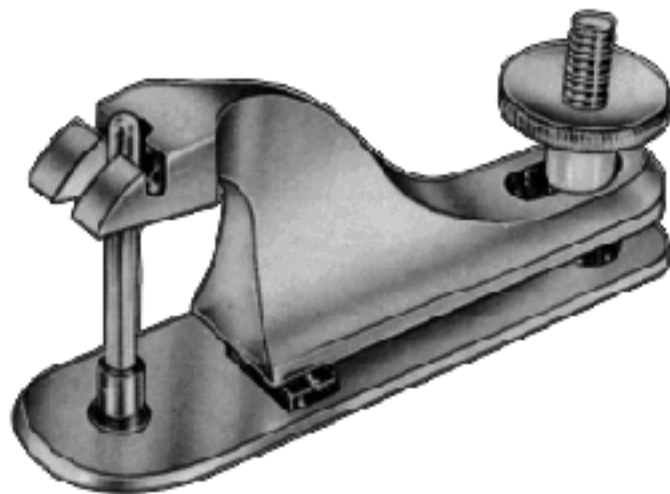

**Gumen Circumcision Clamp**

	mm Ø
F14-186	8
F14-187	11
F14-188	13
F14-189	16
F14-190	21
F14-191	26
F14-192	32



**Stockmann Penile Clamp**  
F14-193 8cm

*Blasenhalssperrer, Blasenwindsperrer*
*Ecarteur pour le col de la vessie, Écarteurs vésicaux*
*Dilatador para el cuello vesical, Separadores vesicales*
*Divaricatore del collo vescicale, Divaricatore vescicale*



**Legueu Bladder Spatula**  
F14-194



**Gosset Bladder Retractor**  
F14-195 160mm

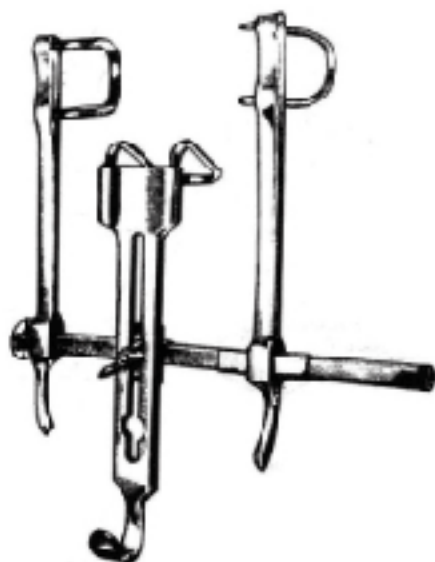

**Thomson Welker Bladder Retractor**  
F14-196



**Pantings Bladder Retractor**  
F14-197



**Judd Masson Bladder Retractor**  
F14-198  
w/arter base



**Millin Bladder Neck Spreader**  
F14-199  
28 cm, 1 1/4"



## HOLLOW WARES

MESH BASKETS

JARS

KIDNEY TRAYS

INSTRUMENTS BOXES

STERILIZING DRUMS

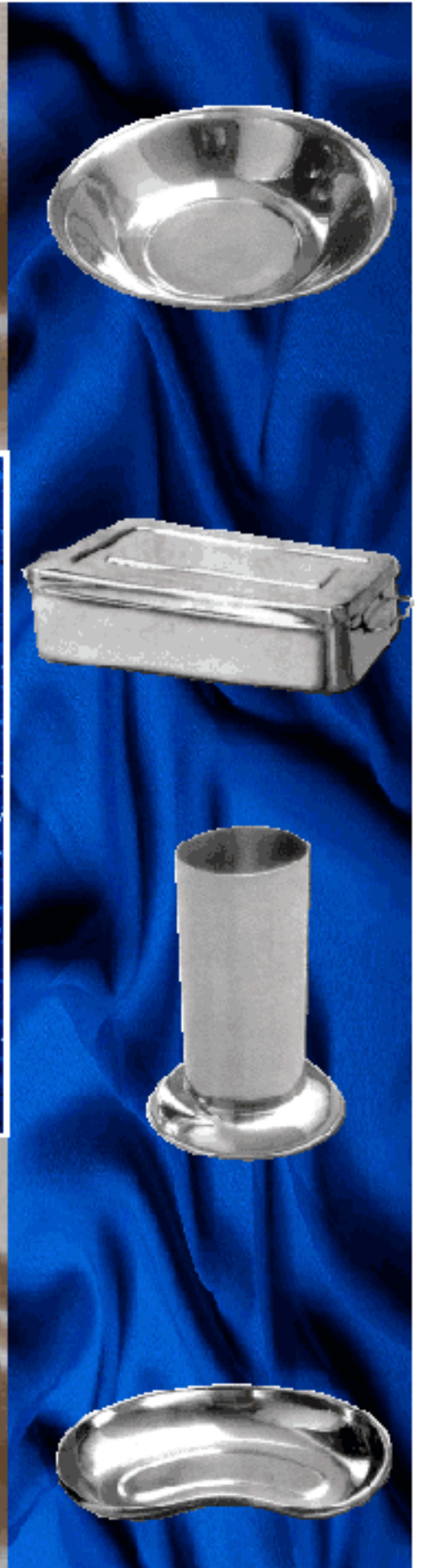



	Ø	h
	mm	mm
F15-001	80	80
F15-002	120	120
F15-003	160	120
F15-004	190	140
F15-005	190	200
F15-006	240	120
F15-007	240	160
F15-008	240	240
F15-009	290	120
F15-010	290	160
F15-011	290	240
F15-012	340	160
F15-013	340	240
F15-014	390	145
F15-015	390	200
F15-016	390	290

**STERILIZING DRUM**

	Ø	h
	mm	Size mm
F15-017	150	150
F15-018	175	175
F15-019	190	190
F15-020	220	140
F15-021	230	200
F15-022	240	120
F15-023	225	225
F15-024	240	240
F15-025	290	160
F15-026	290	240
F15-027	230	150
F15-028	300	250
F15-029	340	250
F15-030	350	250
F15-031	330	200

**STERILIZING DRUM**

	Ø	h
	mm	Size mm
F15-032	150	150
F15-033	175	175
F15-034	190	190
F15-035	200	140
F15-036	200	200
F15-037	240	120
F15-038	225	225
F15-039	240	240
F15-040	290	160
F15-041	280	240
F15-042	250	150
F15-043	300	250
F15-044	340	250
F15-045	350	250
F15-046	350	200

**STERILIZING DRUM**

	Ø	h
	mm	Size mm
F15-047	150	150
F15-048	175	175
F15-049	190	190
F15-050	200	140
F15-051	200	200
F15-052	240	120
F15-053	225	225
F15-054	240	240
F15-055	290	160
F15-056	280	240
F15-057	230	150
F15-058	300	250
F15-059	340	250
F15-060	350	250
F15-061	390	200

**STERILIZING DRUM**

	Ø	h
	mm	Size mm
F15-062	150	150
F15-063	175	175
F15-064	190	190
F15-065	200	140
F15-066	200	200
F15-067	240	120
F15-068	225	225
F15-069	240	240
F15-070	290	160
F15-071	280	240
F15-072	230	150
F15-073	300	250
F15-074	340	250
F15-075	350	250
F15-076	390	200



**G LOVES BOX**  
F15-077  
300 x 150 mm



**INSTRUMENT TRAY WITH COVER**  
F15-078



**INSTRUMENT TRAY**  
F15-079



**CATHER TRAY**

	Size
<b>F15-080</b>	230 x 76 mm
<b>F15-081</b>	350 x 90 mm
<b>F15-082</b>	430 x 100 mm
<b>F15-083</b>	200 x 100 mm
<b>F15-084</b>	300 x 100 mm
<b>F15-085</b>	350 x 100 mm



**PERFORATED BOX**

	Size
<b>F15-086</b>	100 x 50 mm
<b>F15-087</b>	165 x 65 mm
<b>F15-088</b>	250 x 100 mm
<b>F15-089</b>	250 x 150 mm
<b>F15-090</b>	250 x 200 mm
<b>F15-091</b>	150 x 65 mm
<b>F15-092</b>	170 x 70 mm
<b>F15-093</b>	200 x 100 mm
<b>F15-094</b>	250 x 125 mm
<b>F15-095</b>	300 x 150 mm
<b>F15-096</b>	300 x 200 mm
<b>F15-097</b>	300 x 130 mm
<b>F15-098</b>	320 x 150 mm
<b>F15-099</b>	420 x 180 mm
<b>F15-100</b>	460 x 125 mm
<b>F15-101</b>	355 x 180 mm
<b>F15-102</b>	300 x 180 mm
<b>F15-103</b>	400 x 200 mm
<b>F15-104</b>	510 x 200 mm

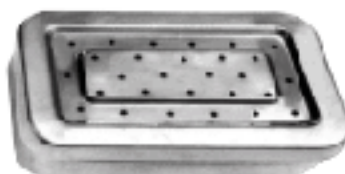

**BOX WITH FILTER**

	Size
<b>F15-105</b>	100 x 50 mm
<b>F15-106</b>	155 x 65 mm
<b>F15-107</b>	250 x 100 mm
<b>F15-108</b>	250 x 150 mm
<b>F15-109</b>	250 x 200 mm
<b>F15-110</b>	150 x 65 mm
<b>F15-111</b>	170 x 70 mm
<b>F15-112</b>	200 x 100 mm
<b>F15-113</b>	250 x 125 mm
<b>F15-114</b>	300 x 150 mm
<b>F15-115</b>	300 x 200 mm
<b>F15-116</b>	300 x 130 mm
<b>F15-117</b>	320 x 150 mm
<b>F15-118</b>	420 x 180 mm
<b>F15-119</b>	450 x 125 mm
<b>F15-120</b>	355 x 180 mm
<b>F15-121</b>	300 x 180 mm
<b>F15-122</b>	400 x 200 mm
<b>F15-123</b>	510 x 200 mm



**INSTRUMENTS BOX**

Without Clip	Size
<b>F15-124</b>	100 x 50 mm
<b>F15-125</b>	165 x 65 mm
<b>F15-126</b>	250 x 100 mm
<b>F15-127</b>	250 x 150 mm
<b>F15-128</b>	250 x 200 mm
<b>F15-129</b>	150 x 65 mm
<b>F15-130</b>	170 x 70 mm
<b>F15-131</b>	200 x 100 mm
<b>F15-132</b>	250 x 125 mm
<b>F15-133</b>	300 x 150 mm
<b>F15-134</b>	300 x 200 mm
<b>F15-135</b>	300 x 130 mm
<b>F15-136</b>	320 x 150 mm
<b>F15-137</b>	420 x 180 mm
<b>F15-138</b>	460 x 125 mm
<b>F15-139</b>	355 x 180 mm
<b>F15-140</b>	300 x 180 mm
<b>F15-141</b>	400 x 200 mm
<b>F15-142</b>	510 x 200 mm



**INSTRUMENT BOX**

With Clip	Size
<b>F15-143</b>	100 x 50 mm
<b>F15-144</b>	165 x 65 mm
<b>F15-145</b>	250 x 100 mm
<b>F15-146</b>	250 x 150 mm
<b>F15-147</b>	250 x 200 mm
<b>F15-148</b>	150 x 65 mm
<b>F15-149</b>	170 x 70 mm
<b>F15-150</b>	200 x 100 mm
<b>F15-151</b>	250 x 125 mm
<b>F15-152</b>	300 x 150 mm
<b>F15-153</b>	300 x 200 mm
<b>F15-154</b>	300 x 130 mm
<b>F15-155</b>	320 x 150 mm
<b>F15-156</b>	420 x 180 mm
<b>F15-157</b>	460 x 125 mm
<b>F15-158</b>	355 x 180 mm
<b>F15-159</b>	300 x 180 mm
<b>F15-160</b>	400 x 200 mm
<b>F15-161</b>	510 x 200 mm

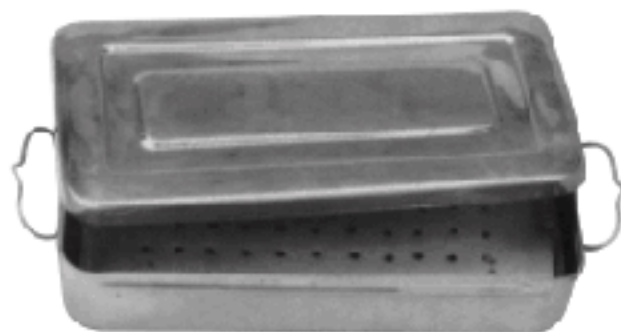

**INSTRUMENT BOILER**

	Size
F15-162	180 x 80 x 40 mm
F15-163	200 x 100 x 50 mm
F15-164	250 x 125 x 40 mm
F15-165	300 x 150 x 60 mm
F15-166	350 x 175 x 75 mm
F15-167	400 x 200 x 100 mm

**PERFORATED TRAY**

	Size
F15-168	180 x 80 x 40 mm
F15-169	200 x 100 x 50 mm
F15-170	250 x 125 x 40 mm
F15-171	300 x 150 x 60 mm
F15-172	350 x 175 x 75 mm
F15-173	400 x 200 x 100 mm

**INSTRUMENT BOILER WITH STAND**

	Size
F15-174	180 x 80 x 40 mm
F15-175	200 x 100 x 50 mm
F15-176	250 x 125 x 40 mm
F15-177	300 x 150 x 60 mm
F15-178	350 x 175 x 75 mm
F15-179	400 x 200 x 100 mm

**INSTRUMENT BOILER ELECTRIC**

	Size
F15-180	180 x 80 x 40 mm
F15-181	200 x 100 x 50 mm
F15-182	250 x 125 x 40 mm
F15-183	300 x 150 x 60 mm
F15-184	350 x 175 x 75 mm
F15-185	400 x 200 x 100 mm



**NEEDLE CASE**  
**F15-186**  
230 x 125 mm

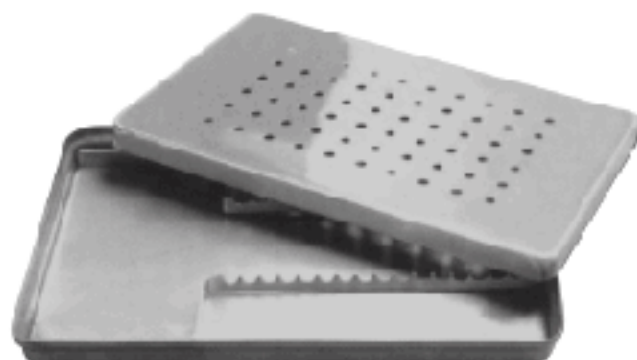

**SCALER BOX**  
**F15-187**  
300 x 180 mm

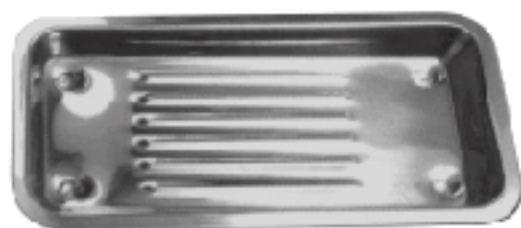

**SCALER TRAY**  
**F15-138**  
100 x 200 mm



**INDO BOX WITH SILVER FRAME**  
**F15-189**

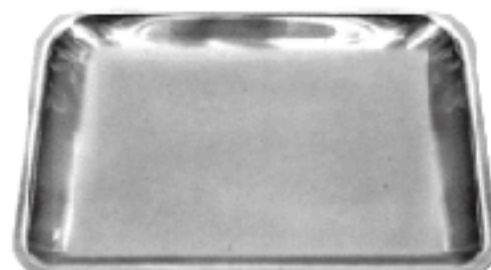
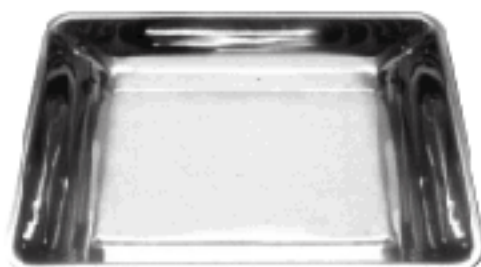

**Autoclavable**  
**F15-190**

**INSTRUMENT TRAY WITHOUT COVER**

Size	Size
<b>F15-191</b> 240 x 240 mm	<b>F15-202</b> 230 x 125 mm
<b>F15-192</b> 365 x 400 mm	<b>F15-203</b> 200 x 160 mm
<b>F15-193</b> 300 x 160 mm	<b>F15-204</b> 250 x 200 mm
<b>F15-194</b> 300 x 180 mm	<b>F15-205</b> 300 x 260 mm
<b>F15-195</b> 300 x 240 mm	<b>F15-206</b> 350 x 300 mm
<b>F15-196</b> 340 x 320 mm	<b>F15-207</b> 400 x 350 mm
<b>F15-197</b> 230 x 100 mm	<b>F15-208</b> 450 x 300 mm
<b>F15-198</b> 250 x 130 mm	<b>F15-209</b> 300 x 200 mm
<b>F15-199</b> 200 x 130 mm	<b>F15-210</b> 350 x 250 mm
<b>F15-200</b> 100 x 130 mm	<b>F15-211</b> 250 x 125 mm
<b>F15-201</b> 150 x 100 mm	<b>F15-212</b> 200 x 100 mm
	<b>F15-213</b> 400 x 200 mm

**INSTRUMENT TRAY WITHOUT COVER**

Size	Size
<b>F15-214</b> 240 x 240 mm	<b>F15-225</b> 230 x 125 mm
<b>F15-215</b> 365 x 400 mm	<b>F15-226</b> 200 x 160 mm
<b>F15-216</b> 300 x 160 mm	<b>F15-227</b> 250 x 200 mm
<b>F15-217</b> 300 x 180 mm	<b>F15-228</b> 300 x 260 mm
<b>F15-218</b> 300 x 240 mm	<b>F15-229</b> 350 x 300 mm
<b>F15-219</b> 340 x 320 mm	<b>F15-230</b> 400 x 350 mm
<b>F15-220</b> 230 x 100 mm	<b>F15-231</b> 450 x 300 mm
<b>F15-221</b> 250 x 130 mm	<b>F15-232</b> 300 x 200 mm
<b>F15-222</b> 200 x 130 mm	<b>F15-233</b> 350 x 250 mm
<b>F15-223</b> 180 x 130 mm	<b>F15-234</b> 250 x 125 mm
<b>F15-224</b> 150 x 100 mm	<b>F15-235</b> 200 x 100 mm
	<b>F15-236</b> 400 x 200 mm

**KIDNEY TRAY WITH COVER**  
 (English Pattern)

	Size
F15-237	150 mm
F15-238	200 mm
F15-239	240 mm
F15-240	300 mm

**KIDNEY TRAY (German Pattern)**  
 (without cover)

	Size
F15-241	150 mm
F15-242	200 mm
F15-243	240 mm
F15-236	300 mm

**SPLIT LAMP**  
 F15-245  
 100 mL

**BOWL**

	Size
F15-246	80 mm
F15-247	100 mm
F15-248	125 mm
F15-249	150 mm
F15-250	200 mm
F15-251	250 mm
F15-252	300 mm
F15-253	350 mm
F15-254	400 mm

**WASH BASIN**

	Size
F15-255	80 mm
F15-256	100 mm
F15-257	125 mm
F15-258	150 mm
F15-259	200 mm
F15-260	250 mm
F15-261	300 mm
F15-262	350 mm
F15-263	400 mm

**BOWL**

	Size
F15-264	80 mm
F15-265	100 mm
F15-266	125 mm
F15-267	150 mm
F15-268	200 mm
F15-269	250 mm
F15-270	300 mm
F15-271	350 mm
F15-272	400 mm

**DRESSING JAR WITH KNOB**

	Size
F15-273	80 x 80 (mm)
F15-274	100 x 100 (mm)
F15-275	125 x 125 (mm)
F15-276	150 x 150 (mm)
F15-277	200 x 200 (mm)

**DRESSING JAR**

	Size
F15-278	90 x 80 (mm)
F15-279	130 x 100 (mm)
F15-280	125 x 125 (mm)
F15-281	150 x 150 (mm)
F15-282	200 x 200 (mm)

**DRESSING JAR**

	Size
F15-283	80 x 80 (mm)
F15-284	100 x 100 (mm)
F15-285	125 x 125 (mm)
F15-286	150 x 150 (mm)
F15-287	200 x 200 (mm)

**DRESSING JAR**

	Size
F15-288	80 x 80 (mm)
F15-289	100 x 100 (mm)
F15-290	125 x 125 (mm)
F15-291	150 x 150 (mm)
F15-292	200 x 200 (mm)

**FORCEPS  
JAR**

	Size
F15-293	55 x 100 mm
F15-294	55 x 140 mm
F15-295	55 x 170 mm
F15-296	55 x 180 mm
F15-297	80 x 100 mm

**FORCEPS  
JAR**

	Size
F15-293	55 x 100 mm
F15-299	55 x 140 mm
F15-300	55 x 170 mm
F15-301	55 x 180 mm
F15-302	80 x 100 mm

**FORCEPS  
JAR**

	Size
F15-303	55 x 100 mm
F15-304	55 x 140 mm
F15-305	55 x 170 mm
F15-306	55 x 180 mm
F15-307	80 x 100 mm

**FORCEPS  
JAR**

	Size
F15-308	55 x 100 mm
F15-309	55 x 140 mm
F15-310	55 x 170 mm
F15-311	55 x 180 mm
F15-312	80 x 100 mm

**FORCEPS  
JAR**

	Size
F15-313	55 x 100 mm
F15-314	55 x 140 mm
F15-315	55 x 170 mm
F15-316	55 x 180 mm
F15-317	80 x 100 mm

**COTTON HCLDER  
F15-318**

**GALIPOTS**

	Capacity
F15-319	2 Ounces
F15-320	3 Ounces
F15-321	4 Ounces
F15-322	5 Ounces
F15-323	6 Ounces
F15-324	7 Ounces
F15-325	8 Ounces

**GALIPOTS**

	Capacity
F15-326	2 Ounces
F15-327	3 Ounces
F15-328	4 Ounces
F15-329	5 Ounces
F15-330	6 Ounces
F15-331	7 Ounces
F15-332	8 Ounces

**SPRIT LAMP  
F15-333  
100 ml.**

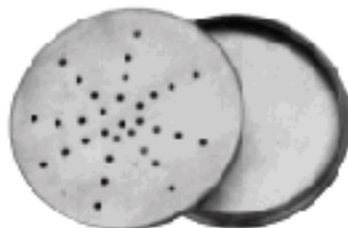
**INDO BOX ROUND  
F15-334**

**NEEDLE CASE  
F15-335**

**MEASURING JUG**

	Capacity
F15-336	1.00 Ltr
F15-337	1.50 Ltr
F15-338	2.00 Ltr

**MEDICINE CUP GRADUATED**

	Capacity
F15-339	50 ml
F15-340	60 ml
F15-341	100 ml

**BUCKET WITH LID**

	Capacity
F15-342	10 Ltr
F15-343	12 Ltr
F15-344	15 Ltr



**SPUTUM MUG**  
**F15-345**  
 100 x 50 mm



**ENEMA CANE**  
 Capacity  
**F15-346** 0.5 Ltr  
**F15-347** 1.5 Ltr  
**F15-348** 2.0 Ltr



**DUST BIN**  
**F16-349**  
 20 Lit



**ROUND BEDPAN**  
**F16-360**  
 300 x 65 mm



**BEDPAN**  
**F16-361**  
 Size: Adult, Child



**BEDPAN**  
**F16-362**  
 Size: Adult, Child



**FUNNAL**  
**F16-353**  
 100 mm



**URINAL - FEMALE**  
**F15-354**



**URINAL - MALE**  
**F15-355**

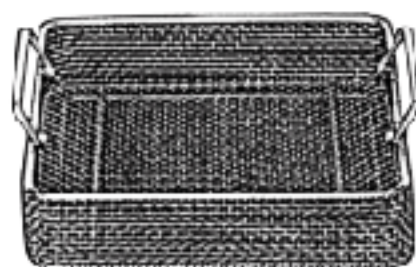

**SHAVING MUG**  
**F15-356**  
 100 mm

**MESH BASKET**

F15-357 240 x 258 x 50 mm  
 F15-358 250 x 240 x 100 mm  
 F15-359 240 x 250 x 60 mm

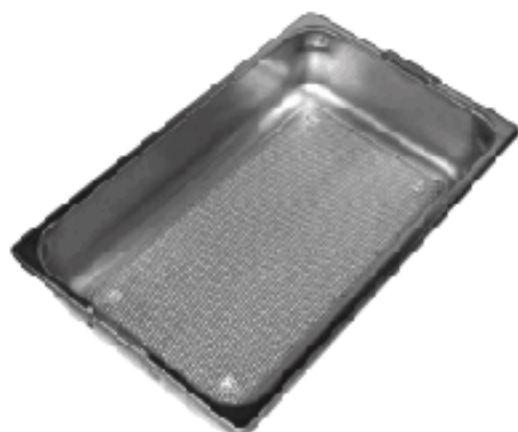

**MESH BASKET**

F15-360 430 x 258 x 50 mm  
 F15-361 430 x 258 x 100 mm  
 F15-362 520 x 258 x 60 mm  
 F15-363 520 x 258 x 70 mm  
 F15-364 450 x 340 x 70 mm  
 F15-365 320 x 230 x 70 mm

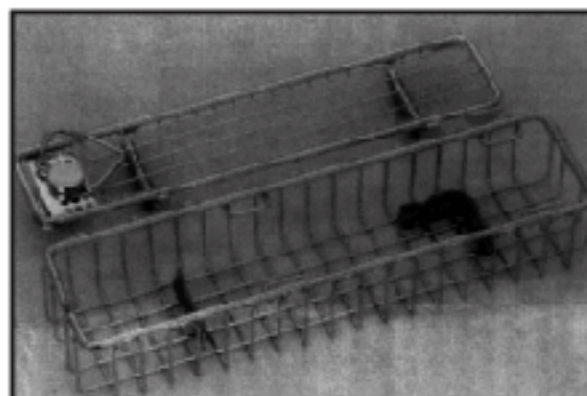

**MESH BASKET**

*With Perforated Sheet Side*

F15-366 230 x 130 x 50 mm  
 F15-367 230 x 130 x 60 mm  
 F15-368 240 x 130 x 50 mm  
 F15-369 240 x 130 x 60 mm  
 F15-370 240 x 250 x 50 mm  
 F15-371 240 x 250 x 60 mm  
 F15-372 480 x 250 x 50 mm  
 F15-373 480 x 250 x 60 mm  
 F15-374 480 x 250 x 70 mm  
 F15-376 300 x 300 x 50 mm  
 F15-376 350 x 350 x 60 mm  
 F15-377 470 x 400 x 60 mm  
 F15-378 480 x 480 x 50 mm  
 F15-379 480 x 480 x 60 mm  
 F15-380 600 x 300 x 50 mm  
 F15-381 620 x 300 x 50 mm  
 F15-382 620 x 300 x 60 mm  
 F15-383 650 x 430 x 50 mm  
 F15-384 600 x 300 x 60 mm

**ARTHROSCOPE BASKET**

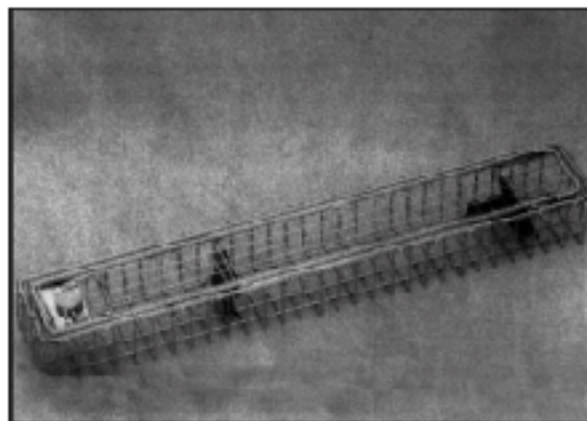
F15-385 290 x 80 x 52 mm

**ENDOSCOPE BASKET**

F15-386 460 x 80 x 52 mm  
 F15-387 660 x 80 x 52 mm  
 F15-388 670 x 80 x 52 mm

*Sterilisieren Zange*
*Pincas stérilisation*
*Pinzas de esterilización*
*Pinze di sterilizzazione*

**DAVIS**  
**F15-386** 16 cm, 5 1/4"  
**F15-390** 20 cm, 3"  
**F15-391** 24 cm, 3 1/2"



**UTILITY**  
**F15-362** 23 cm, 8"  
**F15-363** 23 cm, 11"



**F15-394** 20 cm, 8"  
**F15-395** 25 cm, 10"  
**F15-396** 30 cm, 11 1/4"



**ROGGE**  
**F15-397**  
 27 cm, 11"



**CHEATEL**  
 Box Joint  
**F15-398**  
 27 cm, 11"



**CHEATEL**  
 Screw Joint  
**F15-399**  
 27 cm, 11"



# **fairmount**

## **INDUSTRIES (PVT) LTD.**

**"fairmount"** Stand for Customers Total Satisfaction.

---

**Manufacturers & Exporters of Surgical, Dental Instruments & Scissors all Sorts**

Kotli Behram, Sialkot-51330, Pakistan

Tel: + 92-52-4263082, 4263582

E-mail: [fair@brain.net.pk](mailto:fair@brain.net.pk) [info@fair-mount.com](mailto:info@fair-mount.com)

Fax: + 92-52-4264782, 4263162

[www.fair-mount.com](http://www.fair-mount.com)

Mob: + 92-300-8710140

CERTIFIED  
BY EN 13989:2004



cGMP  
CERTIFIED

